

**DOXIS**

LIGHTING FACTORY

Catalogue May 2014

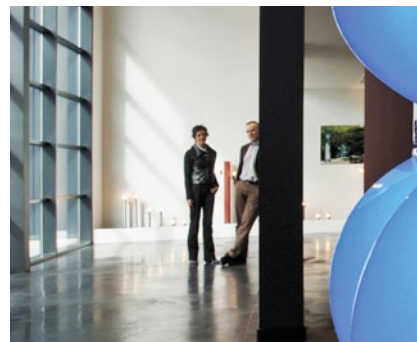



# DOXIS

LIGHTING FACTORY

Founded in 2002, Doxis Lighting Factory is a young and dynamic company. Our designers as well as our team have been in the lighting business for over 20 years. We develop, design, produce and assemble architectural lighting fixtures at our facilities in Genk, Belgium.

Doxis manufactures lighting fixtures to be used in private houses, business, retail, hotel or outdoor environments.

Quality, customer-support and short delays is what we stand for. Long-term partnership is what we are looking for.

Doxis has partnerships with well-known designers, architects and engineers creating very up-to-date designs. Our designers guarantee first quality components and latest technology. Philips, Bridgelux, Citizen, Vossloh-Schwabe, Stucchi, ACL, Jordan, LEDil, etc... to name a few.

Today Doxis is proud to serve dealers in more than 20 countries. Our products are installed all over Europe including Nike shops in Europe, several Tommy Hillfiger shops, several Mc Donalds hamburger restaurants, Jurassic Parc Warswa, KRC fanshop Genk, Belgium, Airport Hong Kong, Airport Bremen (Germany), City Hall Luxemburg, City Hall Heusden-Zolder, Living Tomorrow Brussels, Bocasa Carehome of the Future Heusden-Zolder, Ferrari München, entrance Messe Frankfurt, Kerastase, Istanbul shopping mall, Qatar office block, Opera House Sydney, Postbank Amsterdam, Chiquita Banana HQ, Charlotte, NC.

CE RoHS

All products are built conform CE and RoHS

All prices in this catalogue are excl. VAT, ex works factory, Genk, Belgium

Prices in this catalogue are not bound by type or printing errors and may have been changed since date published.



# Index

## Downlights

### Recessed Single

|                        |    |
|------------------------|----|
| FlatLED T1 .....       | 8  |
| FlatLED T2 .....       | 10 |
| Agati .....            | 12 |
| Breeze Mix.....        | 12 |
| Turn Me .....          | 12 |
| Titan Fix Round .....  | 14 |
| Titan Mix Round .....  | 16 |
| Titan Fix Square ..... | 18 |
| Titan Mix Square ..... | 20 |
| Titan IP54 .....       | 22 |

### Recessed Multiple

|                              |    |
|------------------------------|----|
| Titan 1-Way .....            | 24 |
| Titan 2-Way .....            | 26 |
| Titan 3-Way .....            | 28 |
| Titan 4-Way .....            | 30 |
| Titan 4-Way Square.....      | 32 |
| Titan Double Oval.....       | 34 |
| Titan Double 8-shaped .....  | 36 |
| Titan Double Rectangle ..... | 38 |

### Recessed Professional

|                            |    |
|----------------------------|----|
| Collector Recessed .....   | 40 |
| Many Slim .....            | 42 |
| Many Square .....          | 42 |
| Many Slim Pro Color.....   | 44 |
| Many Square Pro Color..... | 44 |
| Kana .....                 | 46 |
| Kana Pro Color .....       | 48 |
| Kuda .....                 | 50 |
| Kuda Pro Color .....       | 52 |
| Saturnus .....             | 54 |

### Trimless

|                                    |    |
|------------------------------------|----|
| Titan Trimless .....               | 56 |
| Titan Trimless Deep.....           | 58 |
| Titan Trimless Square.....         | 60 |
| Titan Trimless Square Double ..... | 62 |
| Many Trimless .....                | 64 |
| Many Trimless Pro Color .....      | 64 |
| Collector Trimless Square .....    | 66 |
| Collector Trimless Round .....     | 68 |
| Phantom 50 .....                   | 70 |
| Phantom 111 .....                  | 72 |
| Phantom 111 Pro Color .....        | 74 |

## Surface Mounted & Suspended

### Surface Mounted

|                             |    |
|-----------------------------|----|
| Titan Semi-Recessed .....   | 82 |
| Titan Surface Mounted ..... | 84 |
| Titan Box .....             | 90 |
| Titan Suspended T2 .....    | 94 |
| Titan Arm 2-way.....        | 96 |
| Titan Arm 4-way.....        | 98 |
| Collector Box .....         | 88 |
| Cube .....                  | 78 |
| Rondo .....                 | 80 |
| Moody Base.....             | 86 |
| Moody 3-Phase .....         | 86 |

### Suspended

|                       |    |
|-----------------------|----|
| Titan Box .....       | 90 |
| Titan Suspended ..... | 92 |
| Collector Box .....   | 88 |

## Lounge

### Suspended

|                        |     |
|------------------------|-----|
| Tunnel 600 .....       | 102 |
| Tunnel 900 .....       | 102 |
| Tunnel 1200.....       | 102 |
| Tunnel Double .....    | 104 |
| Tunnel Triple .....    | 104 |
| Full moon 400.....     | 106 |
| Full moon 600.....     | 106 |
| Full moon 900.....     | 106 |
| Full moon 1100 .....   | 106 |
| Dome .....             | 108 |
| Dome RGB .....         | 108 |
| Dome Fortimo.....      | 108 |
| Globe Suspended.....   | 114 |
| Eclipse Suspended..... | 114 |
| Palladino.....         | 116 |
| Palladium .....        | 116 |
| Palladium T2.....      | 116 |

### Surface Mounted

|                              |     |
|------------------------------|-----|
| Full moon 400.....           | 106 |
| Full moon 600.....           | 106 |
| Full moon 900.....           | 106 |
| Full moon 1100 .....         | 106 |
| Tube Surface Mounted .....   | 110 |
| Globe Surface Mounted.....   | 112 |
| Eclipse Surface Mounted..... | 112 |
| Palladino.....               | 116 |
| Palladium.....               | 116 |
| Palladium T2.....            | 116 |

### Recessed

|                     |     |
|---------------------|-----|
| Tube Recessed ..... | 110 |
|---------------------|-----|

## Outdoor

|                         |     |
|-------------------------|-----|
| Terra HIT.....          | 122 |
| Terra HIT Asym.....     | 122 |
| Terra Round.....        | 122 |
| Terra Square.....       | 122 |
| Vertex Up / Down.....   | 124 |
| Vertex Double Down..... | 124 |
| Vertex Down .....       | 124 |
| Radar Superlow .....    | 126 |
| Diva .....              | 128 |

## Profiles

### Recessed

|                           |     |
|---------------------------|-----|
| LEDLiner 45 Recessed..... | 132 |
| LEDLiner 65 Recessed..... | 134 |

### Suspended

|                              |     |
|------------------------------|-----|
| LEDLiner 45 Down .....       | 136 |
| LEDLiner 45 Up / Down.....   | 138 |
| LEDLiner 65 Down .....       | 142 |
| LEDLiner 140 Down .....      | 144 |
| LEDLiner 190 Down .....      | 146 |
| LEDLiner 190 + FlatLED ..... | 148 |
| Amazon Down .....            | 150 |
| Amazon Down + Titan .....    | 152 |
| Amazon Titan.....            | 152 |

### Surface Mounted

|                              |     |
|------------------------------|-----|
| LEDLiner 20 Down .....       | 154 |
| LEDLiner 45 Down .....       | 138 |
| LEDLiner 65 Down .....       | 142 |
| LEDLiner 140 Down .....      | 144 |
| LEDLiner 190 Down .....      | 146 |
| LEDLiner 190 + FlatLED ..... | 148 |

### Wall Mounted

|                              |     |
|------------------------------|-----|
| LEDLiner 20 Down .....       | 154 |
| LEDLiner 45 Wall.....        | 140 |
| LEDLiner 65 Down .....       | 142 |
| LEDLiner 140 Down .....      | 144 |
| LEDLiner 190 Down .....      | 146 |
| LEDLiner 190 + FlatLED ..... | 148 |

## Technical

|                                   |     |
|-----------------------------------|-----|
| LED Advantages.....               | 158 |
| Titan variations .....            | 159 |
| Bridgelux Vero 10 LED .....       | 160 |
| Titan LED Replacement .....       | 161 |
| Fortimo LED .....                 | 162 |
| Fortimo Crisp White.....          | 163 |
| Fortimo Food/Meat .....           | 163 |
| Fortimo Cooling .....             | 163 |
| Custom made profiles.....         | 164 |
| Fortimo LEDLine.....              | 165 |
| Fortimo LEDstrip.....             | 165 |
| LEDLine vs. T5 .....              | 166 |
| Wiring .....                      | 168 |
| Xitanium + accessories .....      | 167 |
| Concrete build-in solutions ..... | 168 |
| Article number index.....         | 170 |
| Doxis.....                        | 172 |
| General Terms .....               | 173 |



# Downlights

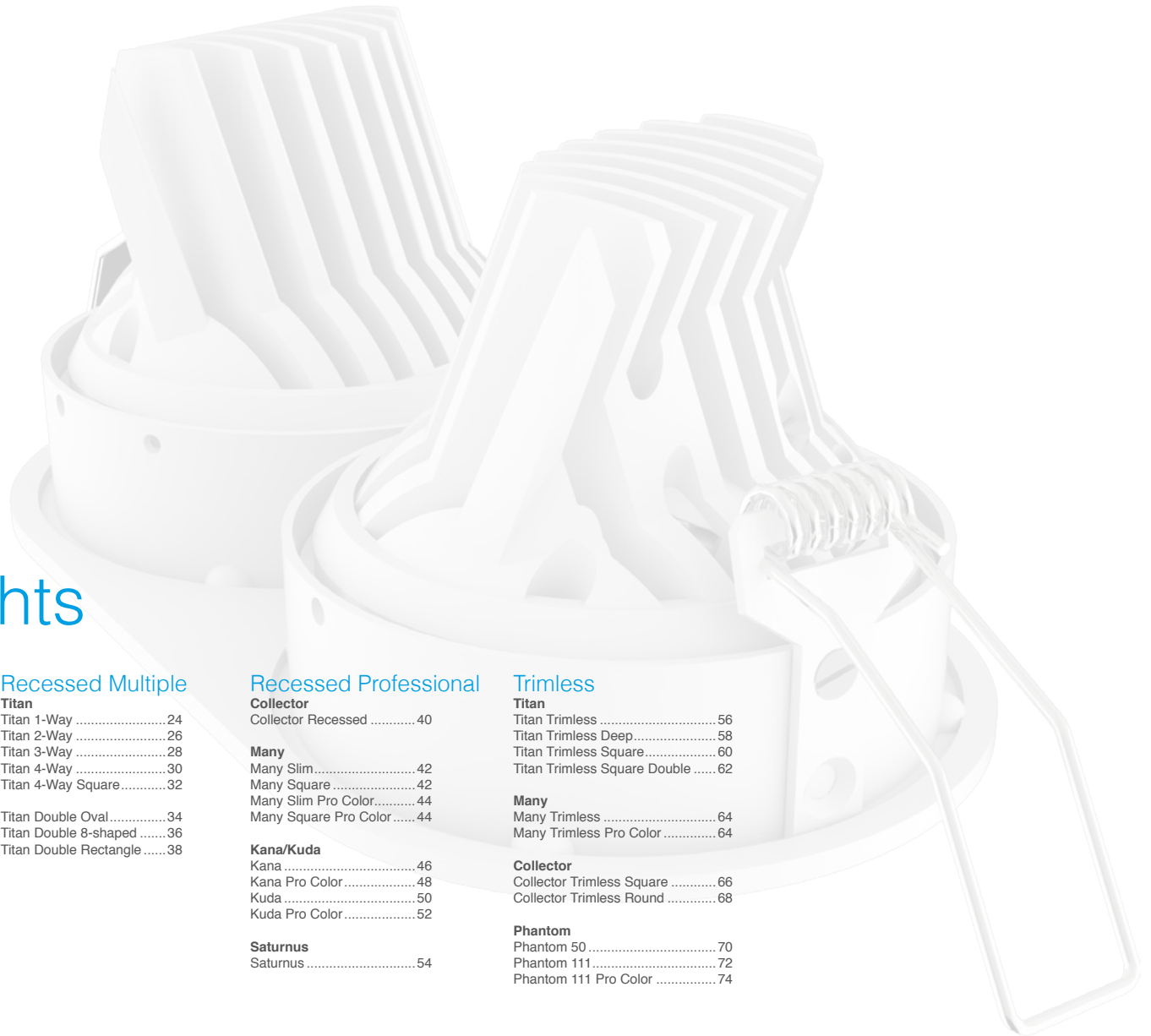

## Recessed Single

|                  |    |
|------------------|----|
| <b>FlatLED</b>   |    |
| FlatLED T1 ..... | 8  |
| FlatLED T2 ..... | 10 |

### Retrofit

|                  |    |
|------------------|----|
| Agati .....      | 12 |
| Breeze Mix ..... | 12 |
| Turn Me .....    | 12 |

### Titan

|                        |    |
|------------------------|----|
| Titan Fix Round .....  | 14 |
| Titan Mix Round .....  | 16 |
| Titan Fix Square ..... | 18 |
| Titan Mix Square ..... | 20 |
| Titan IP54 .....       | 22 |

## Recessed Multiple

|                              |    |
|------------------------------|----|
| <b>Titan</b>                 |    |
| Titan 1-Way .....            | 24 |
| Titan 2-Way .....            | 26 |
| Titan 3-Way .....            | 28 |
| Titan 4-Way .....            | 30 |
| Titan 4-Way Square .....     | 32 |
| Titan Double Oval .....      | 34 |
| Titan Double 8-shaped .....  | 36 |
| Titan Double Rectangle ..... | 38 |

## Recessed Professional

|                             |    |
|-----------------------------|----|
| <b>Collector</b>            |    |
| Collector Recessed .....    | 40 |
| <b>Many</b>                 |    |
| Many Slim .....             | 42 |
| Many Square .....           | 42 |
| Many Slim Pro Color .....   | 44 |
| Many Square Pro Color ..... | 44 |
| <b>Kana/Kuda</b>            |    |
| Kana .....                  | 46 |
| Kana Pro Color .....        | 48 |
| Kuda .....                  | 50 |
| Kuda Pro Color .....        | 52 |
| <b>Saturnus</b>             |    |
| Saturnus .....              | 54 |

## Trimless

|                                    |    |
|------------------------------------|----|
| <b>Titan</b>                       |    |
| Titan Trimless .....               | 56 |
| Titan Trimless Deep .....          | 58 |
| Titan Trimless Square .....        | 60 |
| Titan Trimless Square Double ..... | 62 |
| <b>Many</b>                        |    |
| Many Trimless .....                | 64 |
| Many Trimless Pro Color .....      | 64 |
| <b>Collector</b>                   |    |
| Collector Trimless Square .....    | 66 |
| Collector Trimless Round .....     | 68 |
| <b>Phantom</b>                     |    |
| Phantom 50 .....                   | 70 |
| Phantom 111 .....                  | 72 |
| Phantom 111 Pro Color .....        | 74 |

# FlatLED T1

Type Recessed  
Material Aluminium  
Lamp Orientation Orientable

## LED - Citizen CLL

LED incl.  
Driver to be ordered separately (option)  
Power 13.2W / 360mA  
Lm output 1365lm  
Color temp. 2700K / 3000K  
CRI Ra80  
SDCM 3  
Lifetime 50.000 Hrs (70%)



## Options

|                           |           |         |
|---------------------------|-----------|---------|
| Driver T1 (360mA) non-dim | 490.24.20 | € 30.40 |
| Driver T1 (360mA) 1-10V   | 490.25.20 | € 49.60 |
| Driver T1 (360mA) DALI    | 490.26.20 | € 59.60 |

## On Request

Ra90 or Ra97 on request  
Other RAL colors

## Design awards / Nominations

1. Nominated - Batibouw Brussels (2013)
2. Awarded - Design Plus (2014)

# DESIGN PLUS

powered by: **light+building**



## FlatLED T1

**Citizen LED (350mA) + 37° Lens**

Ra80 - 2700K - 13.2W - 1365lm 465.37.827.xx-B

Ra80 - 3000K - 13.2W - 1365lm 465.37.830.xx-B

€ 137.00

€ 137.00

Available colors: 000.00.000.xx  
**01:** Matt White Texture  
**03:** Matt Black Texture  
**18:** Matt Grey Texture  
 Other RAL colors on request!!

color

# FlatLED T2

Type Recessed  
Material Aluminium  
Lamp Orientation Orientable

## LED - Bridgelux BXRA3

LED incl.  
Driver to be ordered separately (option)  
Power 14.7W / 500mA  
Lm output 1420lm  
Color temp. 2700K  
CRI Ra80  
SDCM 3  
Lifetime 50.000 Hrs (70%)



## Options

|                           |           |         |
|---------------------------|-----------|---------|
| Driver T2 (500mA) non-dim | 491.24.20 | € 35.70 |
| Driver T2 (500mA) 1-10V   | 491.25.20 | € 43.40 |
| Driver T2 (500mA) DALI    | 491.26.20 | € 48.65 |

## On Request

Other RAL colors



## FlatLED T2

### Bridgelux LED (500mA) + 24° Reflector

|                               |                      |          |
|-------------------------------|----------------------|----------|
| Ra80 - 2700K - 14.7W - 1420lm | 465.1420.24.827.xx-B | € 156.00 |
| Ra90 - 2700K - 14.7W - 1200lm | 465.1200.24.927.xx-B | € 156.00 |

### Bridgelux LED (500mA) + 32° Reflector

|                               |                      |          |
|-------------------------------|----------------------|----------|
| Ra80 - 2700K - 14.7W - 1420lm | 465.1420.32.827.xx-B | € 156.00 |
| Ra90 - 2700K - 14.7W - 1200lm | 465.1200.32.927.xx-B | € 156.00 |

Available colors: 000.00.000.xx  
**01:** Matt White Texture  
**03:** Matt Black Texture  
**18:** Matt Grey Texture  
 Other RAL colors on request!!

color

# Agati Breeze Mix Turn Me

Type Recessed  
Material Aluminium  
Lamp Orientation Orientable

**QR-CB51 (MR16)**  
Transformer not included  
Lightsource not included

**GU10**  
Lightsource not included

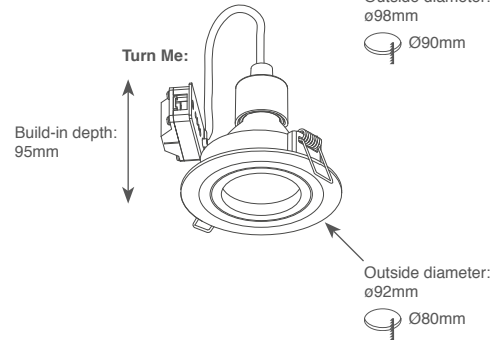
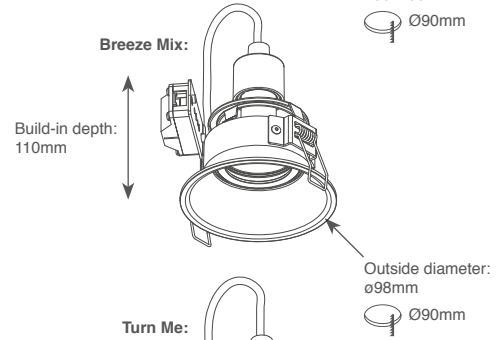
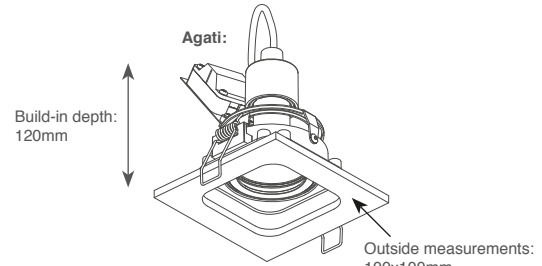





## Agati

### Matt White Texture

GU10 socket 482.05.01 € 30.00

QR-CB51 socket 482.01.01 € 30.00

### Frame: Aluminium Brushed - Inside: black

GU10 socket 482.05.06 € 30.00

QR-CB51 socket 482.01.06 € 30.00



## Breeze Mix

### Matt White Texture

GU10 socket 418.05.01 € 20.00

QR-CB51 socket 418.01.01 € 20.00

### Aluminium Brushed

GU10 socket 418.05.06 € 20.00

QR-CB51 socket 418.01.06 € 20.00



## Turn Me

### Matt White Texture

GU10 socket 430.05.01 € 20.00

QR-CB51 socket 430.01.01 € 20.00

### Aluminium Brushed

GU10 socket 430.05.06 € 20.00

QR-CB51 socket 430.01.06 € 20.00

# Titan Fix Round

Type Recessed  
 Material Aluminium  
 Lamp Orientation Fixed  
**LED - Bridgelux Vero 10**  
 LED incl.  
 Driver to be ordered separately (option)  
 Power 9.2W / 350mA  
 Color temp. / Lm output 2700K: 865lm  
 3000K: 915lm  
 Ra90  
 SDCM 3 (2 on request)  
 Lifetime 50.000 Hrs (70%)

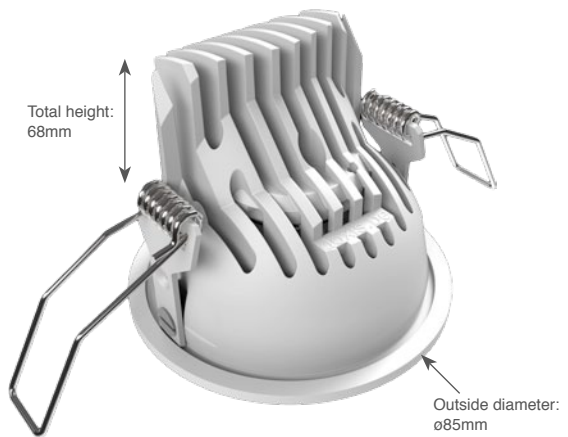
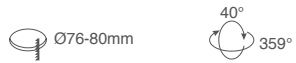

## Options

|                |           |         |
|----------------|-----------|---------|
| Driver non-dim | 490.24.20 | € 26.60 |
| Driver 1-10V   | 490.25.20 | € 43.40 |
| Driver DALI    | 490.26.20 | € 52.10 |

## On Request

LEDs with SDCM 2 (see p.160)  
 LEDs with 4000K (see p.160)  
 CRI up to Ra97 (see p.160)

Other RAL colors



### Titan Fix Round

Cone

**Bridgelux LED (350mA) + 28° Reflector**

|                   |                      |         |
|-------------------|----------------------|---------|
| 2700K - Trapezium | 1007.90.2700.28.01   | € 78.00 |
| 3000K - Trapezium | 1007.90.3000.28.01   | € 78.00 |
| 2700K - Boobytrap | 1007.90.2700.28.01-B | € 78.00 |
| 3000K - Boobytrap | 1007.90.3000.28.01-B | € 78.00 |

**Bridgelux LED (350mA) + 40° Reflector**

|                   |                      |         |
|-------------------|----------------------|---------|
| 2700K - Trapezium | 1007.90.2700.40.01   | € 78.00 |
| 3000K - Trapezium | 1007.90.3000.40.01   | € 78.00 |
| 2700K - Boobytrap | 1007.90.2700.40.01-B | € 78.00 |
| 3000K - Boobytrap | 1007.90.3000.40.01-B | € 78.00 |



### Titan Fix Round

Organic

**Bridgelux LED (350mA) + 28° Reflector**

|                   |                      |         |
|-------------------|----------------------|---------|
| 2700K - Trapezium | 1008.90.2700.28.01   | € 78.00 |
| 3000K - Trapezium | 1008.90.3000.28.01   | € 78.00 |
| 2700K - Boobytrap | 1008.90.2700.28.01-B | € 78.00 |
| 3000K - Boobytrap | 1008.90.3000.28.01-B | € 78.00 |

**Bridgelux LED (350mA) + 40° Reflector**

|                   |                      |         |
|-------------------|----------------------|---------|
| 2700K - Trapezium | 1008.90.2700.40.01   | € 78.00 |
| 3000K - Trapezium | 1008.90.3000.40.01   | € 78.00 |
| 2700K - Boobytrap | 1008.90.2700.40.01-B | € 78.00 |
| 3000K - Boobytrap | 1008.90.3000.40.01-B | € 78.00 |

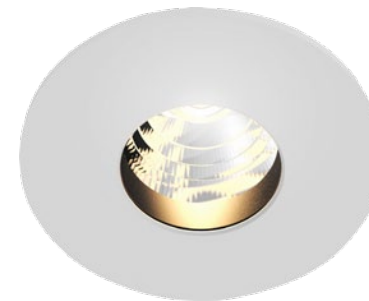

### Titan Fix Round

Anti-glare

**Bridgelux LED (350mA) + 28° Reflector**

|                   |                      |         |
|-------------------|----------------------|---------|
| 2700K - Trapezium | 1009.90.2700.28.01   | € 90.00 |
| 3000K - Trapezium | 1009.90.3000.28.01   | € 90.00 |
| 2700K - Boobytrap | 1009.90.2700.28.01-B | € 90.00 |
| 3000K - Boobytrap | 1009.90.3000.28.01-B | € 90.00 |

**Bridgelux LED (350mA) + 40° Reflector**

|                   |                      |         |
|-------------------|----------------------|---------|
| 2700K - Trapezium | 1009.90.2700.40.01   | € 90.00 |
| 3000K - Trapezium | 1009.90.3000.40.01   | € 90.00 |
| 2700K - Boobytrap | 1009.90.2700.40.01-B | € 90.00 |
| 3000K - Boobytrap | 1009.90.3000.40.01-B | € 90.00 |

Titan has 3 variants: Cone Organic Anti-glare  
  
 More info: p.159



Available colors: 0000.00.0000.00.xx  
 01: Matt White Texture  color  
 Black, grey or other RAL colors on request!!!

# Titan Mix Round

Type Recessed  
Material Aluminium  
Lamp Orientation Orientable

## LED - Bridgelux Vero 10

LED incl.  
Driver to be ordered separately (option)  
Power 9.2W / 350mA  
Color temp. / Lm output  
2700K: 865lm  
3000K: 915lm  
Ra90  
SDCM 3 (2 on request)  
Lifetime 50.000 Hrs (70%)

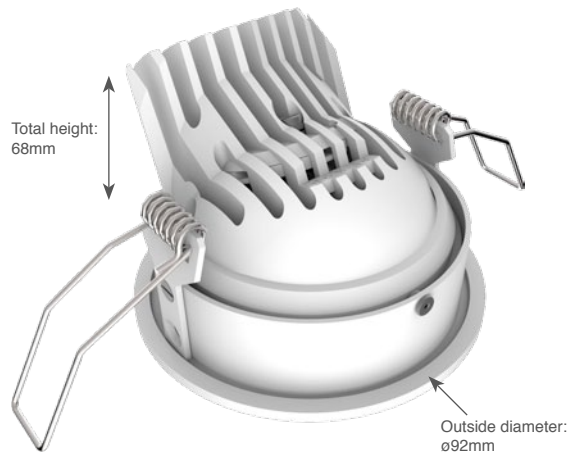
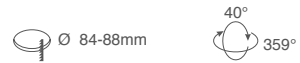

## Options

|                |           |         |
|----------------|-----------|---------|
| Driver non-dim | 490.24.20 | € 26.60 |
| Driver 1-10V   | 490.25.20 | € 43.40 |
| Driver DALI    | 490.26.20 | € 52.10 |

## On Request

LEDs with SDCM 2 (see p.160)  
LEDs with 4000K (see p.160)  
CRI up to Ra97 (see p.160)

Other RAL colors



### Titan Mix Round Cone

|  |                      |         |
|--|----------------------|---------|
| <b>Bridgelux LED (350mA) + 28° Reflector</b> |                      |         |
| 2700K - Trapezium                            | 1010.90.2700.28.01   | € 99.00 |
| 3000K - Trapezium                            | 1010.90.3000.28.01   | € 99.00 |
| 2700K - Boobytrap                            | 1010.90.2700.28.01-B | € 99.00 |
| 3000K - Boobytrap                            | 1010.90.3000.28.01-B | € 99.00 |
| <b>Bridgelux LED (350mA) + 40° Reflector</b> |                      |         |
| 2700K - Trapezium                            | 1010.90.2700.40.01   | € 99.00 |
| 3000K - Trapezium                            | 1010.90.3000.40.01   | € 99.00 |
| 2700K - Boobytrap                            | 1010.90.2700.40.01-B | € 99.00 |
| 3000K - Boobytrap                            | 1010.90.3000.40.01-B | € 99.00 |





### Titan Mix Round Organic

|  |                      |         |
|--|----------------------|---------|
| <b>Bridgelux LED (350mA) + 28° Reflector</b> |                      |         |
| 2700K - Trapezium                            | 1011.90.2700.28.01   | € 99.00 |
| 3000K - Trapezium                            | 1011.90.3000.28.01   | € 99.00 |
| 2700K - Boobytrap                            | 1011.90.2700.28.01-B | € 99.00 |
| 3000K - Boobytrap                            | 1011.90.3000.28.01-B | € 99.00 |
| <b>Bridgelux LED (350mA) + 40° Reflector</b> |                      |         |
| 2700K - Trapezium                            | 1011.90.2700.40.01   | € 99.00 |
| 3000K - Trapezium                            | 1011.90.3000.40.01   | € 99.00 |
| 2700K - Boobytrap                            | 1011.90.2700.40.01-B | € 99.00 |
| 3000K - Boobytrap                            | 1011.90.3000.40.01-B | € 99.00 |



### Titan Mix Round Anti-glare

|  |                      |          |
|--|----------------------|----------|
| <b>Bridgelux LED (350mA) + 28° Reflector</b> |                      |          |
| 2700K - Trapezium                            | 1012.90.2700.28.01   | € 111.00 |
| 3000K - Trapezium                            | 1012.90.3000.28.01   | € 111.00 |
| 2700K - Boobytrap                            | 1012.90.2700.28.01-B | € 111.00 |
| 3000K - Boobytrap                            | 1012.90.3000.28.01-B | € 111.00 |
| <b>Bridgelux LED (350mA) + 40° Reflector</b> |                      |          |
| 2700K - Trapezium                            | 1012.90.2700.40.01   | € 111.00 |
| 3000K - Trapezium                            | 1012.90.3000.40.01   | € 111.00 |
| 2700K - Boobytrap                            | 1012.90.2700.40.01-B | € 111.00 |
| 3000K - Boobytrap                            | 1012.90.3000.40.01-B | € 111.00 |

Titan has 3 variants: Cone   
 Organic   
 Anti-glare   
 More info: p.159



Boobytrap spring



Trapezium spring

Available colors: 0000.00.0000.00.xx  
 01: Matt White Texture  color  
 Black, grey or other RAL colors on request!!!

# Titan Fix Square

|  |                              |
|--|------------------------------|
| Type                                     | Recessed                     |
| Material                                 | Aluminium                    |
| Lamp Orientation                         | Fixed                        |
| <b>LED - Bridgelux Vero 10</b>           |                              |
| LED incl.                                |                              |
| Driver to be ordered separately (option) |                              |
| Power                                    | 9.2W / 350mA                 |
| Color temp. / Lm output                  | 2700K: 865lm<br>3000K: 915lm |
| CRI                                      | Ra90                         |
| SDCM                                     | 3 (2 on request)             |
| Lifetime                                 | 50.000 Hrs (70%)             |

 Ø 76-80mm

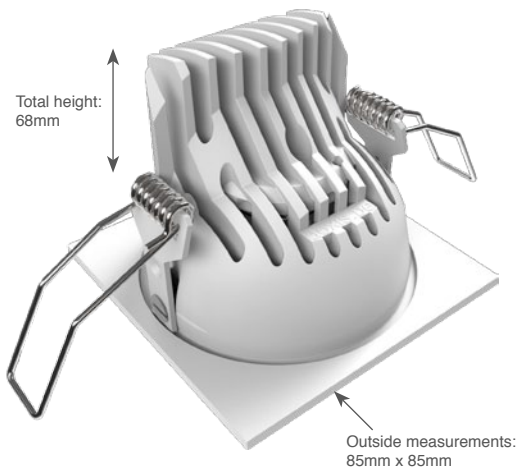

## Options

|                |           |         |
|----------------|-----------|---------|
| Driver non-dim | 490.24.20 | € 26.60 |
| Driver 1-10V   | 490.25.20 | € 43.40 |
| Driver DALI    | 490.26.20 | € 52.10 |

## On Request

LEDs with SDCM 2 (see p.160)  
LEDs with 4000K (see p.160)  
CRI up to Ra97 (see p.160)

Other RAL colors





### Titan Fix Square

Cone

#### Bridgelux LED (350mA) + 28° Reflector

|                   |                      |         |
|-------------------|----------------------|---------|
| 2700K - Trapezium | 1003.90.2700.28.01   | € 81.00 |
| 3000K - Trapezium | 1003.90.3000.28.01   | € 81.00 |
| 2700K - Boobytrap | 1003.90.2700.28.01-B | € 81.00 |
| 3000K - Boobytrap | 1003.90.3000.28.01-B | € 81.00 |

#### Bridgelux LED (350mA) + 40° Reflector

|                   |                      |         |
|-------------------|----------------------|---------|
| 2700K - Trapezium | 1003.90.2700.40.01   | € 81.00 |
| 3000K - Trapezium | 1003.90.3000.40.01   | € 81.00 |
| 2700K - Boobytrap | 1003.90.2700.40.01-B | € 81.00 |
| 3000K - Boobytrap | 1003.90.3000.40.01-B | € 81.00 |



### Titan Fix Square

Organic

#### Bridgelux LED (350mA) + 28° Reflector

|                   |                      |         |
|-------------------|----------------------|---------|
| 2700K - Trapezium | 1001.90.2700.28.01   | € 81.00 |
| 3000K - Trapezium | 1001.90.3000.28.01   | € 81.00 |
| 2700K - Boobytrap | 1001.90.2700.28.01-B | € 81.00 |
| 3000K - Boobytrap | 1001.90.3000.28.01-B | € 81.00 |

#### Bridgelux LED (350mA) + 40° Reflector

|                   |                      |         |
|-------------------|----------------------|---------|
| 2700K - Trapezium | 1001.90.2700.40.01   | € 81.00 |
| 3000K - Trapezium | 1001.90.3000.40.01   | € 81.00 |
| 2700K - Boobytrap | 1001.90.2700.40.01-B | € 81.00 |
| 3000K - Boobytrap | 1001.90.3000.40.01-B | € 81.00 |

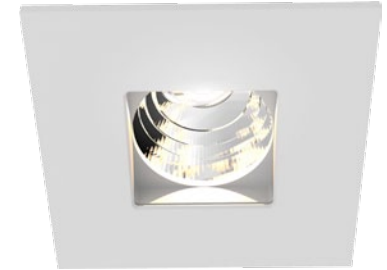

### Titan Fix Square

Anti-glare

#### Bridgelux LED (350mA) + 28° Reflector

|                   |                      |         |
|-------------------|----------------------|---------|
| 2700K - Trapezium | 1000.90.2700.28.01   | € 96.00 |
| 3000K - Trapezium | 1000.90.3000.28.01   | € 96.00 |
| 2700K - Boobytrap | 1000.90.2700.28.01-B | € 96.00 |
| 3000K - Boobytrap | 1000.90.3000.28.01-B | € 96.00 |

#### Bridgelux LED (350mA) + 40° Reflector

|                   |                      |         |
|-------------------|----------------------|---------|
| 2700K - Trapezium | 1000.90.2700.40.01   | € 96.00 |
| 3000K - Trapezium | 1000.90.3000.40.01   | € 96.00 |
| 2700K - Boobytrap | 1000.90.2700.40.01-B | € 96.00 |
| 3000K - Boobytrap | 1000.90.3000.40.01-B | € 96.00 |

Titan has 3 variants: Cone  
Organic  
Anti-glare



More info: p.159



Boobytrap spring



Trapezium spring

Available colors: 0000.00.0000.00.xx  
01: Matt White Texture color  
Black, grey or other RAL colors on request!!

# Titan Mix Square

Type Recessed  
 Material Aluminium  
 Lamp Orientation Orientable

**LED - Bridgelux Vero 10**  
 LED incl.  
 Driver to be ordered separately (option)  
 Power 9.2W / 350mA  
 Color temp. / Lm output 2700K: 865lm  
 3000K: 915lm  
 Ra90  
 SDCM 3 (2 on request)  
 Lifetime 50.000 Hrs (70%)

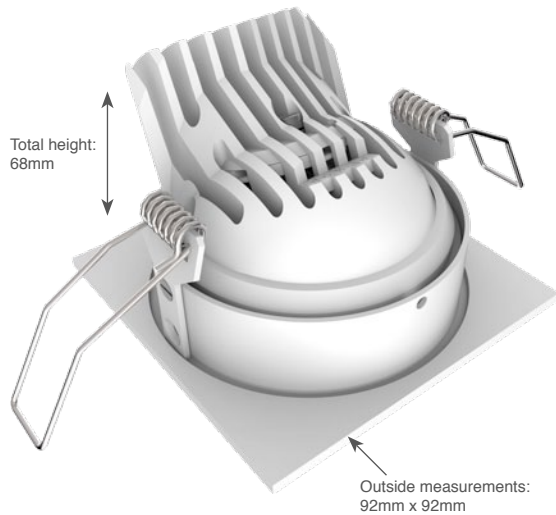
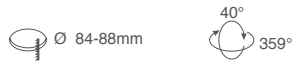

## Options

|                |           |         |
|----------------|-----------|---------|
| Driver non-dim | 490.24.20 | € 26.60 |
| Driver 1-10V   | 490.25.20 | € 43.40 |
| Driver DALI    | 490.26.20 | € 52.10 |

## On Request

LEDs with SDCM 2 (see p.160)  
 LEDs with 4000K (see p.160)  
 CRI up to Ra97 (see p.160)

Other RAL colors



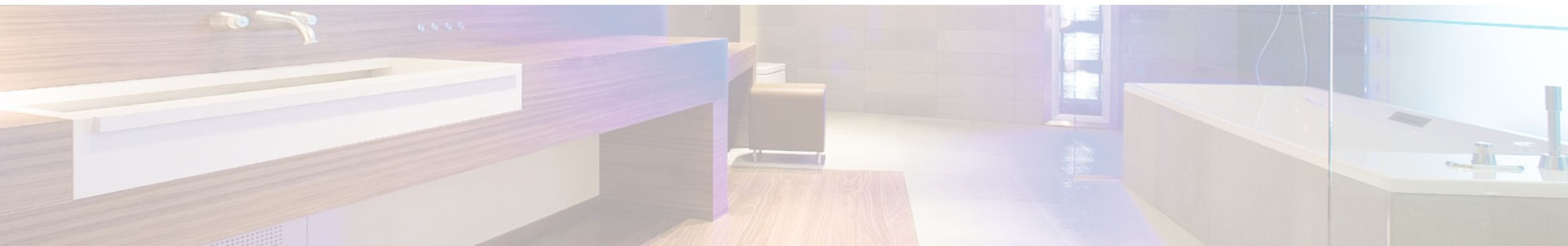

## Titan Mix Square

Cone

### Bridgelux LED (350mA) + 28° Reflector

|                   |                      |          |
|-------------------|----------------------|----------|
| 2700K - Trapezium | 1006.90.2700.28.01   | € 123.00 |
| 3000K - Trapezium | 1006.90.3000.28.01   | € 123.00 |
| 2700K - Boobytrap | 1006.90.2700.28.01-B | € 123.00 |
| 3000K - Boobytrap | 1006.90.3000.28.01-B | € 123.00 |

### Bridgelux LED (350mA) + 40° Reflector

|                   |                      |          |
|-------------------|----------------------|----------|
| 2700K - Trapezium | 1006.90.2700.40.01   | € 123.00 |
| 3000K - Trapezium | 1006.90.3000.40.01   | € 123.00 |
| 2700K - Boobytrap | 1006.90.2700.40.01-B | € 123.00 |
| 3000K - Boobytrap | 1006.90.3000.40.01-B | € 123.00 |



## Titan Mix Square

Organic

### Bridgelux LED (350mA) + 28° Reflector

|                   |                      |          |
|-------------------|----------------------|----------|
| 2700K - Trapezium | 1004.90.2700.28.01   | € 123.00 |
| 3000K - Trapezium | 1004.90.3000.28.01   | € 123.00 |
| 2700K - Boobytrap | 1004.90.2700.28.01-B | € 123.00 |
| 3000K - Boobytrap | 1004.90.3000.28.01-B | € 123.00 |

### Bridgelux LED (350mA) + 40° Reflector

|                   |                      |          |
|-------------------|----------------------|----------|
| 2700K - Trapezium | 1004.90.2700.40.01   | € 123.00 |
| 3000K - Trapezium | 1004.90.3000.40.01   | € 123.00 |
| 2700K - Boobytrap | 1004.90.2700.40.01-B | € 123.00 |
| 3000K - Boobytrap | 1004.90.3000.40.01-B | € 123.00 |

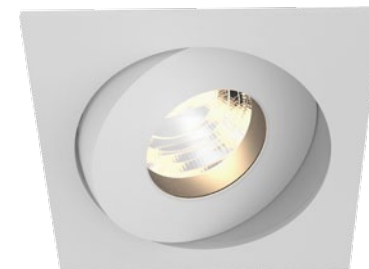

## Titan Mix Square

Anti-glare

### Bridgelux LED (350mA) + 28° Reflector

|                   |                      |          |
|-------------------|----------------------|----------|
| 2700K - Trapezium | 1005.90.2700.28.01   | € 135.00 |
| 3000K - Trapezium | 1005.90.3000.28.01   | € 135.00 |
| 2700K - Boobytrap | 1005.90.2700.28.01-B | € 135.00 |
| 3000K - Boobytrap | 1005.90.3000.28.01-B | € 135.00 |

### Bridgelux LED (350mA) + 40° Reflector

|                   |                      |          |
|-------------------|----------------------|----------|
| 2700K - Trapezium | 1005.90.2700.40.01   | € 135.00 |
| 3000K - Trapezium | 1005.90.3000.40.01   | € 135.00 |
| 2700K - Boobytrap | 1005.90.2700.40.01-B | € 135.00 |
| 3000K - Boobytrap | 1005.90.3000.40.01-B | € 135.00 |

Titan has 3 variants: Cone Organic Anti-glare  
  
 More info: p.159



Boobytrap spring



Trapezium spring

Available colors: 0000.00.0000.00.xx  
 01: Matt White Texture  color  
 Black, grey or other RAL colors on request!!!

# Titan IP54

|  |                              |
|--|------------------------------|
| Type                                     | Recessed                     |
| Material                                 | Aluminium                    |
| Lamp Orientation                         | Fixed                        |
| <b>LED - Bridgelux Vero 10</b>           |                              |
| LED incl.                                |                              |
| Driver to be ordered separately (option) |                              |
| Power                                    | 9.2W / 350mA                 |
| Color temp. / Lm output                  | 2700K: 865lm<br>3000K: 915lm |
| CRI                                      | Ra90                         |
| SDCM                                     | 3 (2 on request)             |
| Lifetime                                 | 50.000 Hrs (70%)             |

 Ø 76-80mm

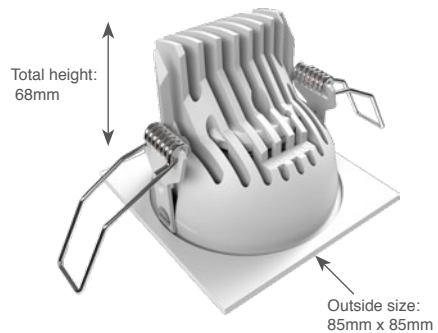
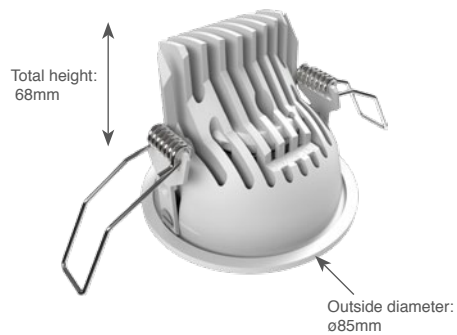

## Options

|                |           |         |
|----------------|-----------|---------|
| Driver non-dim | 490.24.20 | € 26.60 |
| Driver 1-10V   | 490.25.20 | € 43.40 |
| Driver DALI    | 490.26.20 | € 52.10 |

## On Request

LEDs with SDCM 2 (see p.160)  
LEDs with 4000K (see p.160)  
CRI up to Ra97 (see p.160)

Other RAL colors

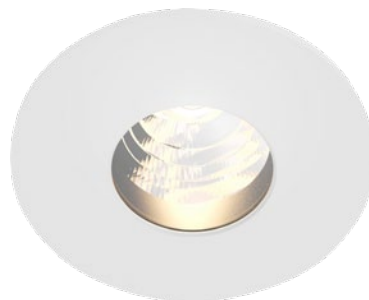

## Titan IP54

Round

### Bridgelux LED (350mA) + 28° Reflector

|                   |                      |         |
|-------------------|----------------------|---------|
| 2700K - Trapezium | 1015.90.2700.28.01   | € 90.00 |
| 3000K - Trapezium | 1015.90.3000.28.01   | € 90.00 |
| 2700K - Boobytrap | 1015.90.2700.28.01-B | € 90.00 |
| 3000K - Boobytrap | 1015.90.3000.28.01-B | € 90.00 |

### Bridgelux LED (350mA) + 40° Reflector

|                   |                      |         |
|-------------------|----------------------|---------|
| 2700K - Trapezium | 1015.90.2700.40.01   | € 90.00 |
| 3000K - Trapezium | 1015.90.3000.40.01   | € 90.00 |
| 2700K - Boobytrap | 1015.90.2700.40.01-B | € 90.00 |
| 3000K - Boobytrap | 1015.90.3000.40.01-B | € 90.00 |



## Titan IP54

Square

### Bridgelux LED (350mA) + 28° Reflector

|                   |                      |          |
|-------------------|----------------------|----------|
| 2700K - Trapezium | 1014.90.2700.28.01   | € 106.00 |
| 3000K - Trapezium | 1014.90.3000.28.01   | € 106.00 |
| 2700K - Boobytrap | 1014.90.2700.28.01-B | € 106.00 |
| 3000K - Boobytrap | 1014.90.3000.28.01-B | € 106.00 |

### Bridgelux LED (350mA) + 40° Reflector

|                   |                      |          |
|-------------------|----------------------|----------|
| 2700K - Trapezium | 1014.90.2700.40.01   | € 106.00 |
| 3000K - Trapezium | 1014.90.3000.40.01   | € 106.00 |
| 2700K - Boobytrap | 1014.90.2700.40.01-B | € 106.00 |
| 3000K - Boobytrap | 1014.90.3000.40.01-B | € 106.00 |



Boobytrap spring



Trapezium spring

Available colors: 0000.00.0000.00.xx  
**01**: Matt White Texture color  
 Black, grey or other RAL colors on request!!

# Titan 1-Way

Type Recessed  
Material Aluminium  
Lamp Orientation Orientable

## LED - Bridgelux Vero 10

LED incl.  
Driver to be ordered separately (option)  
Power 9.2W / 350mA  
Color temp. / Lm output 2700K: 865lm  
3000K: 915lm  
CRI Ra90  
SDCM 3 (2 on request)  
Lifetime 50.000 Hrs (70%)

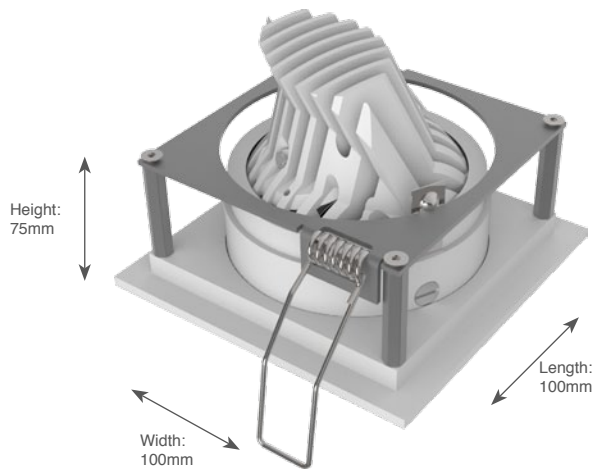
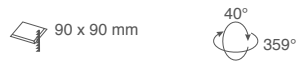

### Options

|                |           |         |
|----------------|-----------|---------|
| Driver non-dim | 490.24.20 | € 26.60 |
| Driver 1-10V   | 490.25.20 | € 43.40 |
| Driver DALI    | 490.26.20 | € 52.10 |

### On Request

LEDs with SDCM 2 (see p.160)  
LEDs with 4000K (see p.160)  
CRI up to Ra97 (see p.160)

Other RAL colors



### Titan 1-Way

Cone

**Bridgelux LED (350mA) + 28° Reflector**

|       |                    |          |
|-------|--------------------|----------|
| 2700K | 1109.90.2700.28.01 | € 115.00 |
| 3000K | 1109.90.3000.28.01 | € 115.00 |

**Bridgelux LED (350mA) + 40° Reflector**

|       |                    |          |
|-------|--------------------|----------|
| 2700K | 1109.90.2700.40.01 | € 115.00 |
| 3000K | 1109.90.3000.40.01 | € 115.00 |



### Titan 1-Way

Organic

**Bridgelux LED (350mA) + 28° Reflector**

|       |                    |          |
|-------|--------------------|----------|
| 2700K | 1110.90.2700.28.01 | € 115.00 |
| 3000K | 1110.90.3000.28.01 | € 115.00 |

**Bridgelux LED (350mA) + 40° Reflector**

|       |                    |          |
|-------|--------------------|----------|
| 2700K | 1110.90.2700.40.01 | € 115.00 |
| 3000K | 1110.90.3000.40.01 | € 115.00 |

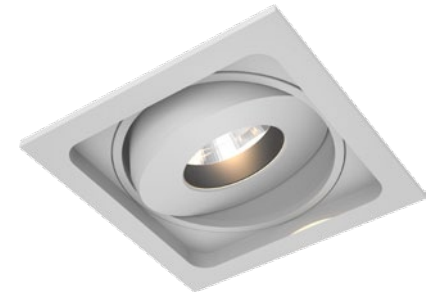

### Titan 1-Way

Anti-glare

**Bridgelux LED (350mA) + 28° Reflector**

|       |                    |          |
|-------|--------------------|----------|
| 2700K | 1111.90.2700.28.01 | € 124.00 |
| 3000K | 1111.90.3000.28.01 | € 124.00 |

**Bridgelux LED (350mA) + 40° Reflector**

|       |                    |          |
|-------|--------------------|----------|
| 2700K | 1111.90.2700.40.01 | € 124.00 |
| 3000K | 1111.90.3000.40.01 | € 124.00 |

Titan has 3 variants: Cone  
 Organic  
 Anti-glare   
 More info: p.159

Available colors: 0000.00.0000.00.xx  
 01: Matt White Texture  color  
 Black, grey or other RAL colors on request!!

# Titan 2-Way

Type Recessed  
Material Aluminium  
Lamp Orientation Orientable

## LED - Bridgelux Vero 10

2x LED incl.

Drivers to be ordered separately

Power (2x) 9.2W / 350mA

Color temp. / Lm output 2700K: (2x) 865lm

3000K: (2x) 915lm

CRI Ra90

SDCM 3 (2 on request)

Lifetime 50.000 Hrs (70%)

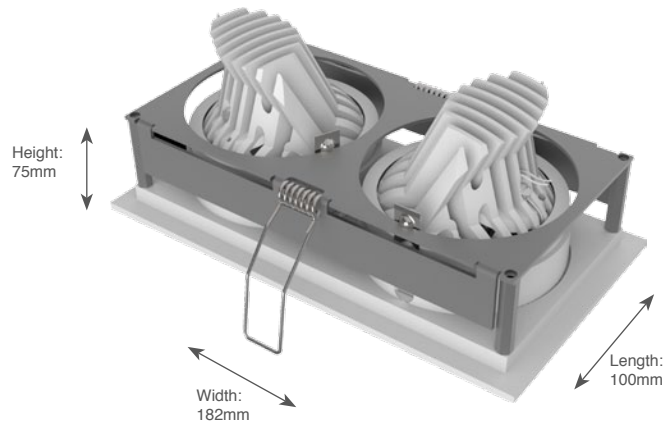

## Options

### 2 Drivers needed for this luminaire

|                |           |         |
|----------------|-----------|---------|
| Driver non-dim | 490.24.20 | € 26.60 |
| Driver 1-10V   | 490.25.20 | € 43.40 |
| Driver DALI    | 490.26.20 | € 52.10 |

## On Request

LEDs with SDCM 2 (see p.160)

LEDs with 4000K (see p.160)

CRI up to Ra97 (see p.160)

Other RAL colors





### Titan 2-Way Cone

|  |                    |          |
|--|--------------------|----------|
| <b>Bridgelux LED (350mA) + 28° Reflector</b> |                    |          |
| 2700K  | 1112.90.2700.28.01 | € 199.00 |
| 3000K  | 1112.90.3000.28.01 | € 199.00 |

|  |                    |          |
|--|--------------------|----------|
| <b>Bridgelux LED (350mA) + 40° Reflector</b> |                    |          |
| 2700K  | 1112.90.2700.40.01 | € 199.00 |
| 3000K  | 1112.90.3000.40.01 | € 199.00 |



### Titan 2-Way Organic

|  |                    |          |
|--|--------------------|----------|
| <b>Bridgelux LED (350mA) + 28° Reflector</b> |                    |          |
| 2700K  | 1113.90.2700.28.01 | € 199.00 |
| 3000K  | 1113.90.3000.28.01 | € 199.00 |

|  |                    |          |
|--|--------------------|----------|
| <b>Bridgelux LED (350mA) + 40° Reflector</b> |                    |          |
| 2700K  | 1113.90.2700.40.01 | € 199.00 |
| 3000K  | 1113.90.3000.40.01 | € 199.00 |



### Titan 2-Way Anti-glare

|  |                    |          |
|--|--------------------|----------|
| <b>Bridgelux LED (350mA) + 28° Reflector</b> |                    |          |
| 2700K  | 1114.90.2700.28.01 | € 217.00 |
| 3000K  | 1114.90.3000.28.01 | € 217.00 |

|  |                    |          |
|--|--------------------|----------|
| <b>Bridgelux LED (350mA) + 40° Reflector</b> |                    |          |
| 2700K  | 1114.90.2700.40.01 | € 217.00 |
| 3000K  | 1114.90.3000.40.01 | € 217.00 |

Titan has 3 variants: Cone  
Organic  
Anti-glare



More info: p.159

Available colors: 0000.00.0000.00.xx  
01: Matt White Texture  color  
Black, grey or other RAL colors on request!!

# Titan 3-Way

Type Recessed  
Material Aluminium  
Lamp Orientation Orientable

## LED - Bridgelux Vero 10

3x LED incl.

Drivers to be ordered separately

Power (3x) 9.2W / 350mA

Color temp. / Lm output 2700K: (3x) 865lm

3000K: (3x) 915lm

CRI Ra90

SDCM 3 (2 on request)

Lifetime 50.000 Hrs (70%)

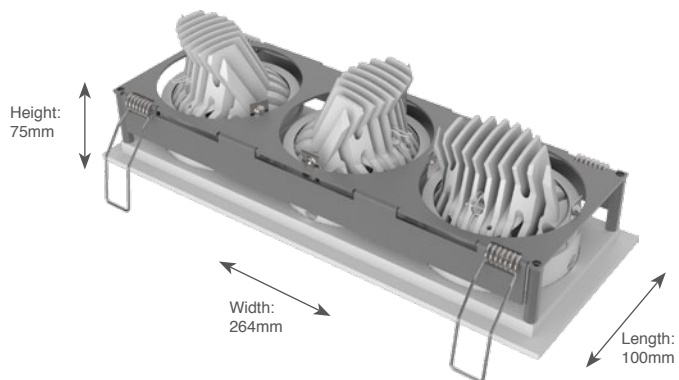

## Options

### 3 Drivers needed for this luminaire

Driver non-dim 490.24.20 € 26.60

Driver 1-10V 490.25.20 € 43.40

Driver DALI 490.26.20 € 52.10

## On Request

LEDs with SDCM 2 (see p.160)

LEDs with 4000K (see p.160)

CRI up to Ra97 (see p.160)

Other RAL colors



"man made electric light...  
to take us out of the dark."

(James Brown)



### Titan 3-Way

Cone

#### Bridgelux LED (350mA) + 28° Reflector

|       |                    |          |
|-------|--------------------|----------|
| 2700K | 1115.90.2700.28.01 | € 295.00 |
| 3000K | 1115.90.3000.28.01 | € 295.00 |

#### Bridgelux LED (350mA) + 40° Reflector

|       |                    |          |
|-------|--------------------|----------|
| 2700K | 1115.90.2700.40.01 | € 295.00 |
| 3000K | 1115.90.3000.40.01 | € 295.00 |



### Titan 3-Way

Organic

#### Bridgelux LED (350mA) + 28° Reflector

|       |                    |          |
|-------|--------------------|----------|
| 2700K | 1116.90.2700.28.01 | € 295.00 |
| 3000K | 1116.90.3000.28.01 | € 295.00 |

#### Bridgelux LED (350mA) + 40° Reflector

|       |                    |          |
|-------|--------------------|----------|
| 2700K | 1116.90.2700.40.01 | € 295.00 |
| 3000K | 1116.90.3000.40.01 | € 295.00 |

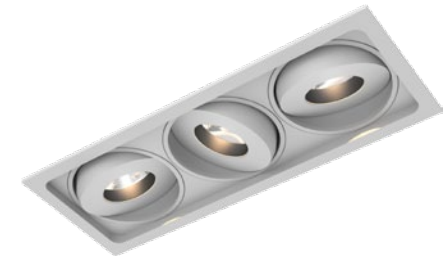

### Titan 3-Way

Anti-glare

#### Bridgelux LED (350mA) + 28° Reflector

|       |                    |          |
|-------|--------------------|----------|
| 2700K | 1117.90.2700.28.01 | € 322.00 |
| 3000K | 1117.90.3000.28.01 | € 322.00 |

#### Bridgelux LED (350mA) + 40° Reflector

|       |                    |          |
|-------|--------------------|----------|
| 2700K | 1117.90.2700.40.01 | € 322.00 |
| 3000K | 1117.90.3000.40.01 | € 322.00 |

Titan has 3 variants: Cone

Organic

Anti-glare

More info: p.159



Available colors: 0000.00.0000.00.xx

01: Matt White Texture

Black, grey or other RAL colors on request!!

color

# Titan 4-Way

Type Recessed  
Material Aluminium  
Lamp Orientation Orientable

## LED - Bridgelux Vero 10

4x LED incl.

Drivers to be ordered separately

Power (4x) 9.2W / 350mA

Color temp. / Lm output 2700K: (4x) 865lm

3000K: (4x) 915lm

CRI Ra90

SDCM 3 (2 on request)

Lifetime 50.000 Hrs (70%)

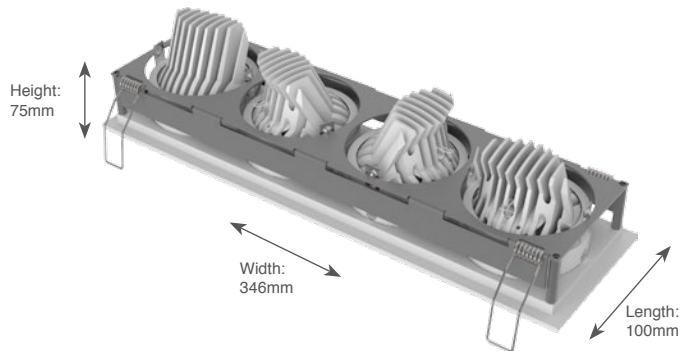

## Options

### 4 Drivers needed for this luminaire

|                |           |         |
|----------------|-----------|---------|
| Driver non-dim | 490.24.20 | € 26.60 |
| Driver 1-10V   | 490.25.20 | € 43.40 |
| Driver DALI    | 490.26.20 | € 52.10 |

## On Request

LEDs with SDCM 2 (see p.160)

LEDs with 4000K (see p.160)

CRI up to Ra97 (see p.160)

Other RAL colors



### Titan 4-Way

Cone

|  |                    |          |
|--|--------------------|----------|
| <b>Bridgelux LED (350mA) + 28° Reflector</b> |                    |          |
| 2700K  | 1118.90.2700.28.01 | € 379.00 |
| 3000K  | 1118.90.3000.28.01 | € 379.00 |

|  |                    |          |
|--|--------------------|----------|
| <b>Bridgelux LED (350mA) + 40° Reflector</b> |                    |          |
| 2700K  | 1118.90.2700.40.01 | € 379.00 |
| 3000K  | 1118.90.3000.40.01 | € 379.00 |



### Titan 4-Way

Organic

|  |                    |          |
|--|--------------------|----------|
| <b>Bridgelux LED (350mA) + 28° Reflector</b> |                    |          |
| 2700K  | 1119.90.2700.28.01 | € 379.00 |
| 3000K  | 1119.90.3000.28.01 | € 379.00 |

|  |                    |          |
|--|--------------------|----------|
| <b>Bridgelux LED (350mA) + 40° Reflector</b> |                    |          |
| 2700K  | 1119.90.2700.40.01 | € 379.00 |
| 3000K  | 1119.90.3000.40.01 | € 379.00 |



### Titan 4-Way

Anti-glare

|  |                    |          |
|--|--------------------|----------|
| <b>Bridgelux LED (350mA) + 28° Reflector</b> |                    |          |
| 2700K  | 1120.90.2700.28.01 | € 414.00 |
| 3000K  | 1120.90.3000.28.01 | € 414.00 |

|  |                    |          |
|--|--------------------|----------|
| <b>Bridgelux LED (350mA) + 40° Reflector</b> |                    |          |
| 2700K  | 1120.90.2700.40.01 | € 414.00 |
| 3000K  | 1120.90.3000.40.01 | € 414.00 |

Titan has 3 variants: Cone  
 Organic  
 Anti-glare



More info: p.159

Available colors: 0000.00.0000.00.xx  
 01: Matt White Texture color  
 Black, grey or other RAL colors on request!!

# Titan

## 4-Way Square

Type Recessed  
 Material Aluminium  
 Lamp Orientation Orientable

### LED - Bridgelux Vero 10

4x LED incl.

Drivers to be ordered separately

Power (4x) 9.2W / 350mA

Color temp. / Lm output 2700K: (4x) 865lm

3000K: (4x) 915lm

CRI Ra90

SDCM 3 (2 on request)

Lifetime 50.000 Hrs (70%)

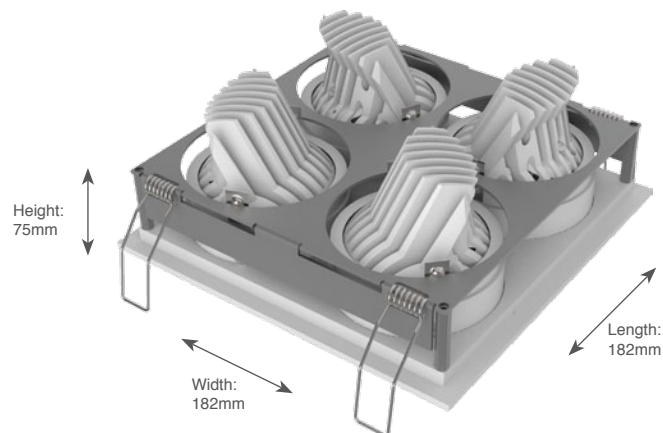

### Options

4 Drivers needed for this luminaire

|                |           |         |
|----------------|-----------|---------|
| Driver non-dim | 490.24.20 | € 26.60 |
| Driver 1-10V   | 490.25.20 | € 43.40 |
| Driver DALI    | 490.26.20 | € 52.10 |

### On Request

LEDs with SDCM 2 (see p.160)

LEDs with 4000K (see p.160)

CRI up to Ra97 (see p.160)

Other RAL colors



### Titan 4-Way Square

Cone

|  |                    |          |
|--|--------------------|----------|
| <b>Bridgelux LED (350mA) + 28° Reflector</b> |                    |          |
| 2700K  | 1121.90.2700.28.01 | € 368.00 |
| 3000K  | 1121.90.3000.28.01 | € 368.00 |

|  |                    |          |
|--|--------------------|----------|
| <b>Bridgelux LED (350mA) + 40° Reflector</b> |                    |          |
| 2700K  | 1121.90.2700.40.01 | € 368.00 |
| 3000K  | 1121.90.3000.40.01 | € 368.00 |



### Titan 4-Way Square

Organic

|  |                    |          |
|--|--------------------|----------|
| <b>Bridgelux LED (350mA) + 28° Reflector</b> |                    |          |
| 2700K  | 1122.90.2700.28.01 | € 368.00 |
| 3000K  | 1122.90.3000.28.01 | € 368.00 |

|  |                    |          |
|--|--------------------|----------|
| <b>Bridgelux LED (350mA) + 40° Reflector</b> |                    |          |
| 2700K  | 1122.90.2700.40.01 | € 368.00 |
| 3000K  | 1122.90.3000.40.01 | € 368.00 |

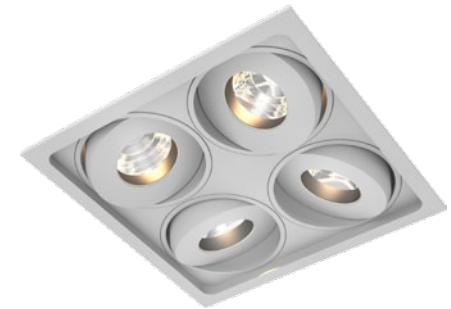

### Titan 4-Way Square

Anti-glare

|  |                    |          |
|--|--------------------|----------|
| <b>Bridgelux LED (350mA) + 28° Reflector</b> |                    |          |
| 2700K  | 1123.90.2700.28.01 | € 403.00 |
| 3000K  | 1123.90.3000.28.01 | € 403.00 |

|  |                    |          |
|--|--------------------|----------|
| <b>Bridgelux LED (350mA) + 40° Reflector</b> |                    |          |
| 2700K  | 1123.90.2700.40.01 | € 403.00 |
| 3000K  | 1123.90.3000.40.01 | € 403.00 |

Titan has 3 variants: Cone  
Organic  
Anti-glare



More info: p.159

Available colors: 0000.00.0000.00.xx  
01: Matt White Texture  color  
Black, grey or other RAL colors on request!!



# Titan Double Oval

Type Recessed  
Material Aluminium  
Lamp Orientation Orientable

**LED - Bridgelux Vero 10**  
2x LED incl.

Drivers to be ordered separately

Power (2x) 9.2W / 350mA  
Color temp. / Lm output 2700K: (2x) 865lm  
3000K: (2x) 915lm

CRI Ra90  
SDCM 3 (2 on request)  
Lifetime 50.000 Hrs (70%)

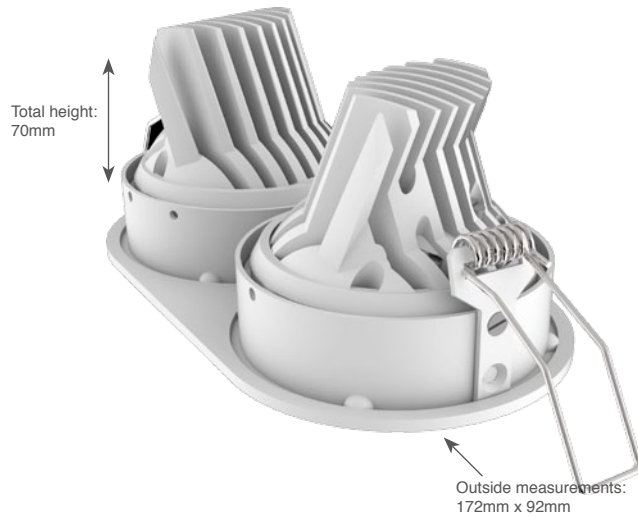
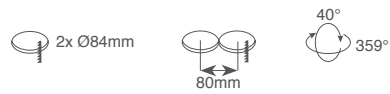

## Options

**2 Drivers needed for this luminaire**

|                |           |         |
|----------------|-----------|---------|
| Driver non-dim | 490.24.20 | € 26.60 |
| Driver 1-10V   | 490.25.20 | € 43.40 |
| Driver DALI    | 490.26.20 | € 52.10 |

## On Request

LEDs with SDCM 2 (see p.160)  
LEDs with 4000K (see p.160)  
CRI up to Ra97 (see p.160)

Other RAL colors



### Titan Double Oval

Cone

|  |                    |          |
|--|--------------------|----------|
| <b>Bridgelux LED (350mA) + 28° Reflector</b> |                    |          |
| 2700K  | 1103.90.2700.28.01 | € 215.00 |
| 3000K  | 1103.90.3000.28.01 | € 215.00 |

|  |                    |          |
|--|--------------------|----------|
| <b>Bridgelux LED (350mA) + 40° Reflector</b> |                    |          |
| 2700K  | 1103.90.2700.40.01 | € 215.00 |
| 3000K  | 1103.90.3000.40.01 | € 215.00 |



### Titan Double Oval

Organic

|  |                    |          |
|--|--------------------|----------|
| <b>Bridgelux LED (350mA) + 28° Reflector</b> |                    |          |
| 2700K  | 1105.90.2700.28.01 | € 215.00 |
| 3000K  | 1105.90.3000.28.01 | € 215.00 |

|  |                    |          |
|--|--------------------|----------|
| <b>Bridgelux LED (350mA) + 40° Reflector</b> |                    |          |
| 2700K  | 1105.90.2700.40.01 | € 215.00 |
| 3000K  | 1105.90.3000.40.01 | € 215.00 |



### Titan Double Oval

Anti-glare

|  |                    |          |
|--|--------------------|----------|
| <b>Bridgelux LED (350mA) + 28° Reflector</b> |                    |          |
| 2700K  | 1104.90.2700.28.01 | € 231.00 |
| 3000K  | 1104.90.3000.28.01 | € 231.00 |

|  |                    |          |
|--|--------------------|----------|
| <b>Bridgelux LED (350mA) + 40° Reflector</b> |                    |          |
| 2700K  | 1104.90.2700.40.01 | € 231.00 |
| 3000K  | 1104.90.3000.40.01 | € 231.00 |

Titan has 3 variants: Cone  
 Organic  
 Anti-glare  
 More info: p.159



Available colors: 0000.00.0000.00.xx  
 01: Matt White Texture  
 Black, grey or other RAL colors on request!!

# Titan Double

## 8-Shaped

Type Recessed  
 Material Aluminium  
 Lamp Orientation Orientable

### LED - Bridgelux Vero 10

2x LED incl.

Drivers to be ordered separately

Power (2x) 9.2W / 350mA

Color temp. / Lm output 2700K: (2x) 865lm

3000K: (2x) 915lm

CRI Ra90

SDCM 3 (2 on request)

Lifetime 50.000 Hrs (70%)

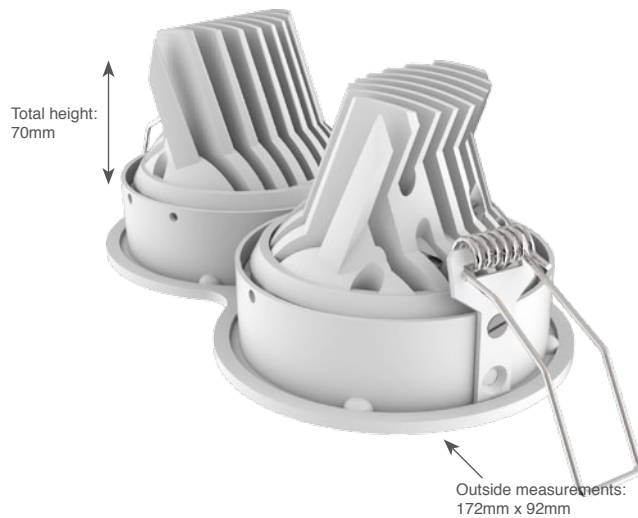

### Options

#### 2 Drivers needed for this luminaire

|                |           |         |
|----------------|-----------|---------|
| Driver non-dim | 490.24.20 | € 26.60 |
| Driver 1-10V   | 490.25.20 | € 43.40 |
| Driver DALI    | 490.26.20 | € 52.10 |

### On Request

LEDs with SDCM 2 (see p.160)

LEDs with 4000K (see p.160)

CRI up to Ra97 (see p.160)

Other RAL colors





## Titan Double 8

Cone

|  |                    |          |
|--|--------------------|----------|
| <b>Bridgelux LED (350mA) + 28° Reflector</b> |                    |          |
| 2700K  | 1106.90.2700.28.01 | € 215.00 |
| 3000K  | 1106.90.3000.28.01 | € 215.00 |

|  |                    |          |
|--|--------------------|----------|
| <b>Bridgelux LED (350mA) + 40° Reflector</b> |                    |          |
| 2700K  | 1106.90.2700.40.01 | € 215.00 |
| 3000K  | 1106.90.3000.40.01 | € 215.00 |



## Titan Double 8

Organic

|  |                    |          |
|--|--------------------|----------|
| <b>Bridgelux LED (350mA) + 28° Reflector</b> |                    |          |
| 2700K  | 1108.90.2700.28.01 | € 215.00 |
| 3000K  | 1108.90.3000.28.01 | € 215.00 |

|  |                    |          |
|--|--------------------|----------|
| <b>Bridgelux LED (350mA) + 40° Reflector</b> |                    |          |
| 2700K  | 1108.90.2700.40.01 | € 215.00 |
| 3000K  | 1108.90.3000.40.01 | € 215.00 |



## Titan Double 8

Anti-glare

|  |                    |          |
|--|--------------------|----------|
| <b>Bridgelux LED (350mA) + 28° Reflector</b> |                    |          |
| 2700K  | 1107.90.2700.28.01 | € 231.00 |
| 3000K  | 1107.90.3000.28.01 | € 231.00 |

|  |                    |          |
|--|--------------------|----------|
| <b>Bridgelux LED (350mA) + 40° Reflector</b> |                    |          |
| 2700K  | 1107.90.2700.40.01 | € 231.00 |
| 3000K  | 1107.90.3000.40.01 | € 231.00 |

Titan has 3 variants: Cone  
 Organic  
 Anti-glare  
 More info: p.159



Available colors: 0000.00.0000.00.xx  
 01: Matt White Texture color  
 Black, grey or other RAL colors on request!!

# Titan Double Rectangle

Type Recessed  
Material Aluminium  
Lamp Orientation Orientable

## LED - Bridgelux Vero 10

2x LED incl.

Drivers to be ordered separately

Power (2x) 9.2W / 350mA

Color temp. / Lm output 2700K: (2x) 865lm

3000K: (2x) 915lm

CRI Ra90

SDCM 3 (2 on request)

Lifetime 50.000 Hrs (70%)

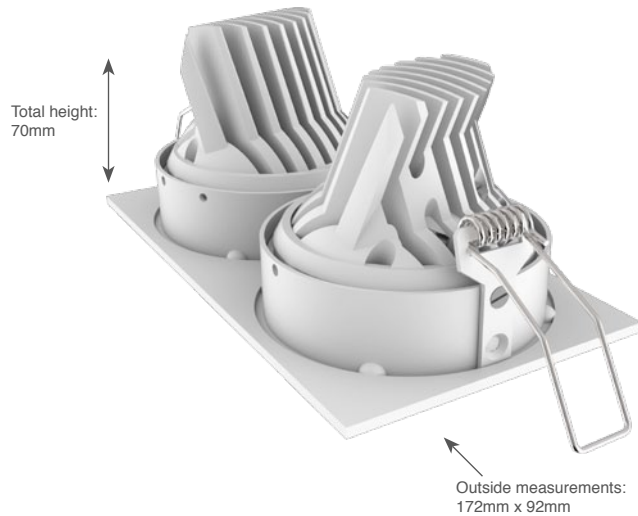

## Options

### 2 Drivers needed for this luminaire

|                |           |         |
|----------------|-----------|---------|
| Driver non-dim | 490.24.20 | € 26.60 |
| Driver 1-10V   | 490.25.20 | € 43.40 |
| Driver DALI    | 490.26.20 | € 52.10 |

## On Request

LEDs with SDCM 2 (see p.160)

LEDs with 4000K (see p.160)

CRI up to Ra97 (see p.160)

Other RAL colors



### Titan Double Rectangle

Cone

|  |                    |          |
|--|--------------------|----------|
| <b>Bridgelux LED (350mA) + 28° Reflector</b> |                    |          |
| 2700K  | 1100.90.2700.28.01 | € 215.00 |
| 3000K  | 1100.90.3000.28.01 | € 215.00 |

|  |                    |          |
|--|--------------------|----------|
| <b>Bridgelux LED (350mA) + 40° Reflector</b> |                    |          |
| 2700K  | 1100.90.2700.40.01 | € 215.00 |
| 3000K  | 1100.90.3000.40.01 | € 215.00 |



### Titan Double Rectangle

Organic

|  |                    |          |
|--|--------------------|----------|
| <b>Bridgelux LED (350mA) + 28° Reflector</b> |                    |          |
| 2700K  | 1102.90.2700.28.01 | € 215.00 |
| 3000K  | 1102.90.3000.28.01 | € 215.00 |

|  |                    |          |
|--|--------------------|----------|
| <b>Bridgelux LED (350mA) + 40° Reflector</b> |                    |          |
| 2700K  | 1102.90.2700.40.01 | € 215.00 |
| 3000K  | 1102.90.3000.40.01 | € 215.00 |



### Titan Double Rectangle

Anti-glare

|  |                    |          |
|--|--------------------|----------|
| <b>Bridgelux LED (350mA) + 28° Reflector</b> |                    |          |
| 2700K  | 1101.90.2700.28.01 | € 231.00 |
| 3000K  | 1101.90.3000.28.01 | € 231.00 |

|  |                    |          |
|--|--------------------|----------|
| <b>Bridgelux LED (350mA) + 40° Reflector</b> |                    |          |
| 2700K  | 1101.90.2700.40.01 | € 231.00 |
| 3000K  | 1101.90.3000.40.01 | € 231.00 |

Titan has 3 variants: Cone  
 Organic  
 Anti-glare



More info: p.159

Available colors: 0000.00.0000.00.xx  
 01: Matt White Texture color  
 Black, grey or other RAL colors on request!!

# Collector Recessed

Type Recessed  
 Material Aluminium  
 Lamp Orientation Orientable

## QR-111

Lightsource not incl.  
 Transformer not incl.  
 Socket G53

## CDM-TC

Lightsource not incl.  
 Ballast not incl.  
 Reflector incl.  
 Socket G8.5

## CDM-R-111

Lightsource not incl.  
 Ballast not incl.  
 Socket Gx8.5

## LED - Philips Fortimo SLM Passive

LED incl.  
 Driver incl.  
 Power 18W  
 Lm output 2000lm  
 Cooling Passive (no fan)  
 Color Temp. 3000K / 4000K  
 CRI Ra80 / Ra90  
 SDCM 3  
 Lifetime 50.000 Hrs (70%)

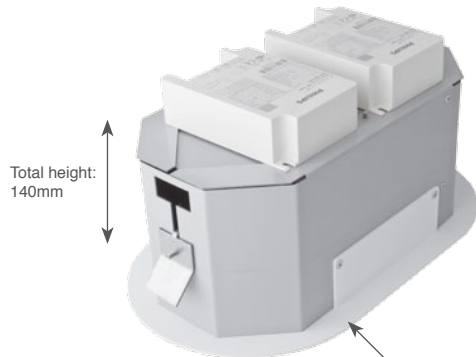

Outside measurements:  
 Single: ø180mm  
 Double: 307mm x 180mm  
 Triple: 435mm x 180mm



## Options

|                        |           |         |
|------------------------|-----------|---------|
| Electronic Ballast 35W | 490.00.35 | € 52.50 |
| Electronic Ballast 70W | 490.00.70 | € 52.50 |
| Transformer 60VA       | 490.00.60 | € 14.00 |
| Transformer 105VA      | 490.01.05 | € 16.00 |

## Included

LED Drivers included on all LED-luminaires  
 Reflector(s) included on CDM-TC luminaires

Single: Ø150mm

Double: 2x Ø150mm +



Triple: 2x Ø150mm +







## Collector Recessed

### Single

|               |             |          |
|---------------|-------------|----------|
| 1x QR-111     | 414.07.xx   | € 86.00  |
| 1x CDM-TC 30° | 414.13.xx-S | € 110.00 |
| 1x CDM-R-111  | 414.14.xx   | € 117.00 |

### 1x Philips Fortimo SLM 2000lm - 24° - Non dim.

|                                    |                      |          |
|------------------------------------|----------------------|----------|
| Ra80 - 3000K - 17.4W - 119-104lm/W | 414.2000.24.830.xx-C | € 199.00 |
| Ra80 - 4000K - 17.4W - 126-110lm/W | 414.2000.24.840.xx-C | € 199.00 |
| Ra90 - 3000K - 17.4W - 97-84lm/W   | 414.2000.24.930.xx-C | € 199.00 |
| Ra90 - 4000K - 17.4W - 104-91lm/W  | 414.2000.24.940.xx-C | € 199.00 |

### 1x Philips Fortimo SLM 2000lm - 36° - Non dim.

|                                    |                      |          |
|------------------------------------|----------------------|----------|
| Ra80 - 3000K - 17.4W - 119-104lm/W | 414.2000.36.830.xx-C | € 199.00 |
| Ra80 - 4000K - 17.4W - 126-110lm/W | 414.2000.36.840.xx-C | € 199.00 |
| Ra90 - 3000K - 17.4W - 97-84lm/W   | 414.2000.36.930.xx-C | € 199.00 |
| Ra90 - 4000K - 17.4W - 104-91lm/W  | 414.2000.36.940.xx-C | € 199.00 |

### 1x Philips Fortimo SLM 2000lm - 24° - Touch DIM & DALI

|                                    |                      |          |
|------------------------------------|----------------------|----------|
| Ra80 - 3000K - 17.4W - 119-104lm/W | 414.2000.24.830.xx-D | € 233.00 |
| Ra80 - 4000K - 17.4W - 126-110lm/W | 414.2000.24.840.xx-D | € 233.00 |
| Ra90 - 3000K - 17.4W - 97-84lm/W   | 414.2000.24.930.xx-D | € 233.00 |
| Ra90 - 4000K - 17.4W - 104-91lm/W  | 414.2000.24.940.xx-D | € 233.00 |

### 1x Philips Fortimo SLM 2000lm - 36° - Touch DIM & DALI

|                                    |                      |          |
|------------------------------------|----------------------|----------|
| Ra80 - 3000K - 17.4W - 119-104lm/W | 414.2000.36.830.xx-D | € 233.00 |
| Ra80 - 4000K - 17.4W - 126-110lm/W | 414.2000.36.840.xx-D | € 233.00 |
| Ra90 - 3000K - 17.4W - 97-84lm/W   | 414.2000.36.930.xx-D | € 233.00 |
| Ra90 - 4000K - 17.4W - 104-91lm/W  | 414.2000.36.940.xx-D | € 233.00 |

#### LED vs. system efficacy

|                                    |                 |
|------------------------------------|-----------------|
| Ra00 - 0000K - 00.0W - 000-000lm/W |                 |
| LED efficacy                       | System efficacy |



## Collector Recessed

### Double

|               |             |          |
|---------------|-------------|----------|
| 2x QR-111     | 415.07.xx   | € 119.00 |
| 2x CDM-TC 30° | 415.13.xx-S | € 179.00 |
| 2x CDM-R-111  | 415.14.xx   | € 193.00 |

### 2x Philips Fortimo SLM 2000lm - 24° - Non dim.

|                                      |                      |          |
|--------------------------------------|----------------------|----------|
| Ra80 - 3000K - 2x17.4W - 119-104lm/W | 415.2000.24.830.xx-C | € 361.00 |
| Ra80 - 4000K - 2x17.4W - 126-110lm/W | 415.2000.24.840.xx-C | € 361.00 |
| Ra90 - 3000K - 2x17.4W - 97-84lm/W   | 415.2000.24.930.xx-C | € 361.00 |
| Ra90 - 4000K - 2x17.4W - 104-91lm/W  | 415.2000.24.940.xx-C | € 361.00 |

### 2x Philips Fortimo SLM 2000lm - 36° - Non dim.

|                                      |                      |          |
|--------------------------------------|----------------------|----------|
| Ra80 - 3000K - 2x17.4W - 119-104lm/W | 415.2000.36.830.xx-C | € 361.00 |
| Ra80 - 4000K - 2x17.4W - 126-110lm/W | 415.2000.36.840.xx-C | € 361.00 |
| Ra90 - 3000K - 2x17.4W - 97-84lm/W   | 415.2000.36.930.xx-C | € 361.00 |
| Ra90 - 4000K - 2x17.4W - 104-91lm/W  | 415.2000.36.940.xx-C | € 361.00 |

### 2x Philips Fortimo SLM 2000lm - 24° - Touch DIM & DALI

|                                      |                      |          |
|--------------------------------------|----------------------|----------|
| Ra80 - 3000K - 2x17.4W - 119-104lm/W | 415.2000.24.830.xx-D | € 451.00 |
| Ra80 - 4000K - 2x17.4W - 126-110lm/W | 415.2000.24.840.xx-D | € 451.00 |
| Ra90 - 3000K - 2x17.4W - 97-84lm/W   | 415.2000.24.930.xx-D | € 451.00 |
| Ra90 - 4000K - 2x17.4W - 104-91lm/W  | 415.2000.24.940.xx-D | € 451.00 |

### 2x Philips Fortimo SLM 2000lm - 36° - Touch DIM & DALI

|                                      |                      |          |
|--------------------------------------|----------------------|----------|
| Ra80 - 3000K - 2x17.4W - 119-104lm/W | 415.2000.36.830.xx-D | € 451.00 |
| Ra80 - 4000K - 2x17.4W - 126-110lm/W | 415.2000.36.840.xx-D | € 451.00 |
| Ra90 - 3000K - 2x17.4W - 97-84lm/W   | 415.2000.36.930.xx-D | € 451.00 |
| Ra90 - 4000K - 2x17.4W - 104-91lm/W  | 415.2000.36.940.xx-D | € 451.00 |

#### Available colors: 0000.0000.00. xx

- 01: Matt White Texture
  - 05: Matt White Texture + Matt Black Texture
- color  
Matt Black Texture on request



## Collector Recessed

### Triple

|               |             |          |
|---------------|-------------|----------|
| 3x QR-111     | 416.07.xx   | € 145.00 |
| 3x CDM-TC 30° | 416.13.xx-S | € 215.00 |
| 3x CDM-R-111  | 416.14.xx   | € 235.00 |

### 3x Philips Fortimo SLM 2000lm - 24° - Non dim.

|                                      |                      |          |
|--------------------------------------|----------------------|----------|
| Ra80 - 3000K - 3x17.4W - 119-104lm/W | 416.2000.24.830.xx-C | € 511.00 |
| Ra80 - 4000K - 3x17.4W - 126-110lm/W | 416.2000.24.840.xx-C | € 511.00 |
| Ra90 - 3000K - 3x17.4W - 97-84lm/W   | 416.2000.24.930.xx-C | € 511.00 |
| Ra90 - 4000K - 3x17.4W - 104-91lm/W  | 416.2000.24.940.xx-C | € 511.00 |

### 3x Philips Fortimo SLM 2000lm - 36° - Non dim.

|                                      |                      |          |
|--------------------------------------|----------------------|----------|
| Ra80 - 3000K - 3x17.4W - 119-104lm/W | 416.2000.36.830.xx-C | € 511.00 |
| Ra80 - 4000K - 3x17.4W - 126-110lm/W | 416.2000.36.840.xx-C | € 511.00 |
| Ra90 - 3000K - 3x17.4W - 97-84lm/W   | 416.2000.36.930.xx-C | € 511.00 |
| Ra90 - 4000K - 3x17.4W - 104-91lm/W  | 416.2000.36.940.xx-C | € 511.00 |

### 3x Philips Fortimo SLM 2000lm - 24° - Touch DIM & DALI

|                                      |                      |          |
|--------------------------------------|----------------------|----------|
| Ra80 - 3000K - 3x17.4W - 119-104lm/W | 416.2000.24.830.xx-D | € 646.00 |
| Ra80 - 4000K - 3x17.4W - 126-110lm/W | 416.2000.24.840.xx-D | € 646.00 |
| Ra90 - 3000K - 3x17.4W - 97-84lm/W   | 416.2000.24.930.xx-D | € 646.00 |
| Ra90 - 4000K - 3x17.4W - 104-91lm/W  | 416.2000.24.940.xx-D | € 646.00 |

### 3x Philips Fortimo SLM 2000lm - 36° - Touch DIM & DALI

|                                      |                      |          |
|--------------------------------------|----------------------|----------|
| Ra80 - 3000K - 3x17.4W - 119-104lm/W | 416.2000.36.830.xx-D | € 646.00 |
| Ra80 - 4000K - 3x17.4W - 126-110lm/W | 416.2000.36.840.xx-D | € 646.00 |
| Ra90 - 3000K - 3x17.4W - 97-84lm/W   | 416.2000.36.930.xx-D | € 646.00 |
| Ra90 - 4000K - 3x17.4W - 104-91lm/W  | 416.2000.36.940.xx-D | € 646.00 |

#### Available beam angles: 000.0000.AA.000.00-0

- 24: 24° Reflector
  - 36: 36° Reflector
- Beam angle

# Many

Type Recessed  
Material Aluminium  
Lamp Orientation Fixed

## LED - Philips Fortimo SLM Passive

LED incl.  
Driver incl.  
Power 18W / 28W  
Lm output 2000 / 3000  
Cooling 2000lm: Passive (no fan)  
3000lm: Passive (no fan)  
Color Temp. 3000K / 4000K  
CRI Ra80 / Ra90  
SDCM 3  
Lifetime 50.000 Hrs (70%)

Ø90 mm

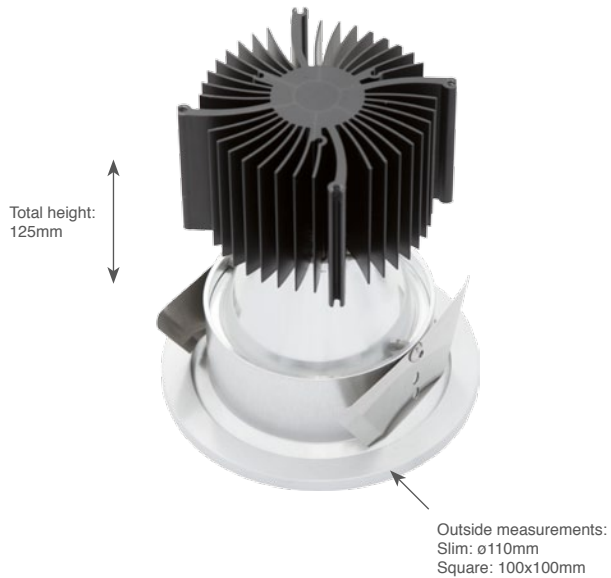

Included  
LED Drivers included



Passive cooling

### Many Square 2 Standard (Passive cooling)

|  |                      |          |  |
|--|----------------------|----------|--|
| <b>Philips Fortimo SLM 2000lm - Non dim.</b> |                      |          |  |
| Ra80 - 3000K - 17.4W - 119-104lm/W           | 440.2000.AA.830.06-C | € 193.00 |  |
| Ra80 - 4000K - 17.4W - 126-110lm/W           | 440.2000.AA.840.06-C | € 193.00 |  |
| Ra90 - 3000K - 17.4W - 97-84lm/W             | 440.2000.AA.930.06-C | € 193.00 |  |
| Ra90 - 4000K - 17.4W - 104-91lm/W            | 440.2000.AA.940.06-C | € 193.00 |  |

|  |                      |          |  |
|--|----------------------|----------|--|
| <b>Philips Fortimo SLM 2000lm - Touch DIM &amp; DALI</b> |                      |          |  |
| Ra80 - 3000K - 17.4W - 119-104lm/W                       | 440.2000.AA.830.06-D | € 243.00 |  |
| Ra80 - 4000K - 17.4W - 126-110lm/W                       | 440.2000.AA.840.06-D | € 243.00 |  |
| Ra90 - 3000K - 17.4W - 97-84lm/W                         | 440.2000.AA.930.06-D | € 243.00 |  |
| Ra90 - 4000K - 17.4W - 104-91lm/W                        | 440.2000.AA.940.06-D | € 243.00 |  |

|  |                      |          |  |
|--|----------------------|----------|--|
| <b>Philips Fortimo SLM 3000lm - Non dim.</b> |                      |          |  |
| Ra80 - 3000K - 25.9W - 118-103lm/W           | 440.3000.AA.830.06-C | € 219.00 |  |
| Ra80 - 4000K - 25.9W - 126-110lm/W           | 440.3000.AA.840.06-C | € 219.00 |  |
| Ra90 - 3000K - 25.9W - 95-83lm/W             | 440.3000.AA.930.06-C | € 219.00 |  |
| Ra90 - 4000K - 25.9W - 103-90lm/W            | 440.3000.AA.940.06-C | € 219.00 |  |

|  |                      |          |  |
|--|----------------------|----------|--|
| <b>Philips Fortimo SLM 3000lm - Touch DIM &amp; DALI</b> |                      |          |  |
| Ra80 - 3000K - 25.9W - 118-103lm/W                       | 440.3000.AA.830.06-D | € 270.00 |  |
| Ra80 - 4000K - 25.9W - 126-110lm/W                       | 440.3000.AA.840.06-D | € 270.00 |  |
| Ra90 - 3000K - 25.9W - 95-83lm/W                         | 440.3000.AA.930.06-D | € 270.00 |  |
| Ra90 - 4000K - 25.9W - 103-90lm/W                        | 440.3000.AA.940.06-D | € 270.00 |  |



Passive cooling

### Many Slim Standard (Passive cooling)

|  |                      |          |  |
|--|----------------------|----------|--|
| <b>Philips Fortimo SLM 2000lm - Non dim.</b> |                      |          |  |
| Ra80 - 3000K - 17.4W - 119-104lm/W           | 444.2000.AA.830.06-C | € 178.00 |  |
| Ra80 - 4000K - 17.4W - 126-110lm/W           | 444.2000.AA.840.06-C | € 178.00 |  |
| Ra90 - 3000K - 17.4W - 97-84lm/W             | 444.2000.AA.930.06-C | € 178.00 |  |
| Ra90 - 4000K - 17.4W - 104-91lm/W            | 444.2000.AA.940.06-C | € 178.00 |  |

|  |                      |          |  |
|--|----------------------|----------|--|
| <b>Philips Fortimo SLM 2000lm - Touch DIM &amp; DALI</b> |                      |          |  |
| Ra80 - 3000K - 17.4W - 119-104lm/W                       | 444.2000.AA.830.06-D | € 228.00 |  |
| Ra80 - 4000K - 17.4W - 126-110lm/W                       | 444.2000.AA.840.06-D | € 228.00 |  |
| Ra90 - 3000K - 17.4W - 97-84lm/W                         | 444.2000.AA.930.06-D | € 228.00 |  |
| Ra90 - 4000K - 17.4W - 104-91lm/W                        | 444.2000.AA.940.06-D | € 228.00 |  |

|  |                      |          |  |
|--|----------------------|----------|--|
| <b>Philips Fortimo SLM 3000lm - Non dim.</b> |                      |          |  |
| Ra80 - 3000K - 25.9W - 118-103lm/W           | 444.3000.AA.830.06-C | € 204.00 |  |
| Ra80 - 4000K - 25.9W - 126-110lm/W           | 444.3000.AA.840.06-C | € 204.00 |  |
| Ra90 - 3000K - 25.9W - 95-83lm/W             | 444.3000.AA.930.06-C | € 204.00 |  |
| Ra90 - 4000K - 25.9W - 103-90lm/W            | 444.3000.AA.940.06-C | € 204.00 |  |

|  |                      |          |  |
|--|----------------------|----------|--|
| <b>Philips Fortimo SLM 3000lm - Touch DIM &amp; DALI</b> |                      |          |  |
| Ra80 - 3000K - 25.9W - 118-103lm/W                       | 444.3000.AA.830.06-D | € 254.00 |  |
| Ra80 - 4000K - 25.9W - 126-110lm/W                       | 444.3000.AA.840.06-D | € 254.00 |  |
| Ra90 - 3000K - 25.9W - 95-83lm/W                         | 444.3000.AA.930.06-D | € 254.00 |  |
| Ra90 - 4000K - 25.9W - 103-90lm/W                        | 444.3000.AA.940.06-D | € 254.00 |  |

\*DALI Dim:  
Dimming is possible by both DALI protocol as  
by using touch dim dimmers.

**LED vs. system efficacy**  
Ra00 - 0000K - 00.0W - 000-000lm/W  
LED efficacy  System efficacy

**Available beam angles:** 000.0000.AA.000.00-0  
**24:** 24° Reflector  Beam angle  
**36:** 36° Reflector

**Available colors:** 0000.0000.00.xx  
**06:** Aluminium Anodised  color

# Many Professional Color

Type Recessed  
 Material Aluminium  
 Lamp Orientation Fixed

## LED - Philips Fortimo SLM Active

LED incl.  
 Driver incl.  
 Power 33.7W / 42.3W / 42.3W  
 Lm output 3000 / 2750 / 2960  
 Cooling Active (fan)  
 Color Temp. 2600K / 3100K  
 CRI Ra80 / Ra90  
 Color spec. Crisp white / Food / Meat  
 SDCM 3  
 Lifetime 50.000 Hrs (70%)

Ø90 mm



Total height: 140mm

Outside measurements:  
 Slim: ø110mm  
 Square: 100x100mm

Build-in depth:  
 240mm (100mm free space required for ventilation)  
 Do not topload with isolation materials!

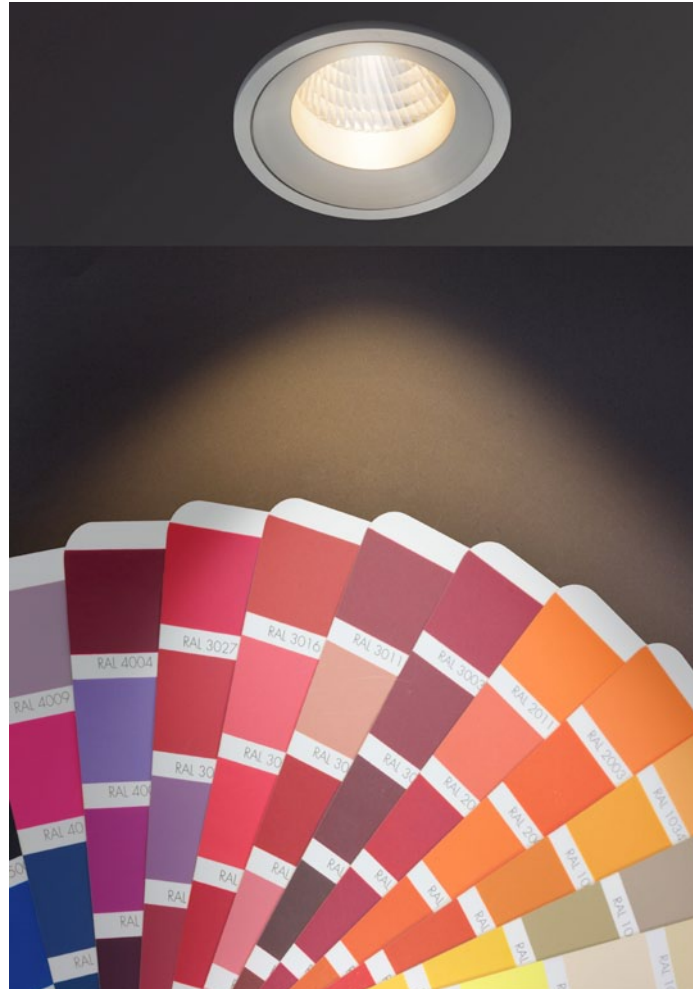

### Color specs

|  | Color Temp. | CRI (Ra) | R9  | X     | Y     |
|--|-------------|----------|-----|-------|-------|
| <b>Philips Fortimo SLM Crisp White</b> | 3000K       | 90       | ≥50 | 0.430 | 0.395 |
| <b>Philips Fortimo SLM Food</b>        | 2600K       | 90       | ≥70 | 0.450 | 0.380 |
| <b>Philips Fortimo SLM Meat</b>        | 3100K       | 90       | ≥50 | 0.396 | 0.333 |

### Included

LED Drivers included





Active cooling

### Many Square 2

Professional color (Active cooling)

- Philips Fortimo SLM Crisp White 3000lm\***  
Non dim. - 33.7W - 88-77lm/W 440.3000.AA.CW.06-C € 240.00  
DALI dim. - 33.7W - 88-77lm/W 440.3000.AA.CW.06-D € 290.00
- Philips Fortimo SLM Food 2750lm\***  
DALI dim. - 42.3W - 65-56lm/W 440.2750.AA.F.06-D € 333.00  
Non dim. version available 4th quarter of 2014
- Philips Fortimo SLM Meat 2960lm\***  
DALI dim. - 42.3W - 70-61lm/W 440.2960.AA.M.06-D € 333.00  
Non dim. version available 4th quarter of 2014



Active cooling

### Many Slim

Professional color (Active cooling)

- Philips Fortimo SLM Crisp White 3000lm\***  
Non dim. - 33.7W - 88-77lm/W 444.3000.AA.CW.06-C € 225.00  
DALI dim. - 33.7W - 88-77lm/W 444.3000.AA.CW.06-D € 275.00
- Philips Fortimo SLM Food 2750lm\***  
DALI dim. - 42.3W - 65-56lm/W 444.2750.AA.F.06-D € 318.00  
Non dim. version available 4th quarter of 2014
- Philips Fortimo SLM Meat 2960lm\***  
DALI dim. - 42.3W - 70-61lm/W 444.2960.AA.M.06-D € 318.00  
Non dim. version available 4th quarter of 2014

\*DALI Dim:  
Dimming is possible by both DALI protocol as  
by using touch dim dimmers.

**LED vs. system efficacy**  
Ra00 - 0000K - 00.0W - 000-000lm/W  
LED efficacy  System efficacy

**Available beam angles:** 000.0000.AA.000.00-0  
**24:** 24° Reflector  Beam angle  
**36:** 36° Reflector

**Available colors:** 0000.0000.00. **xx**  
**06:** Aluminium Anodised  color

# Kana Standard

Type Recessed  
Material Aluminium  
Lamp Orientation Orientable

## LED - Philips Fortimo SLM Passive

LED incl.  
Driver incl.  
Power 18W / 28W  
Lm output 2000 / 3000  
Cooling 2000lm: Passive (no fan)  
3000lm: Passive (no fan)  
Color Temp. 3000K / 4000K  
CRI Ra80 / Ra90  
SDCM 3  
Lifetime 50.000 Hrs (70%)

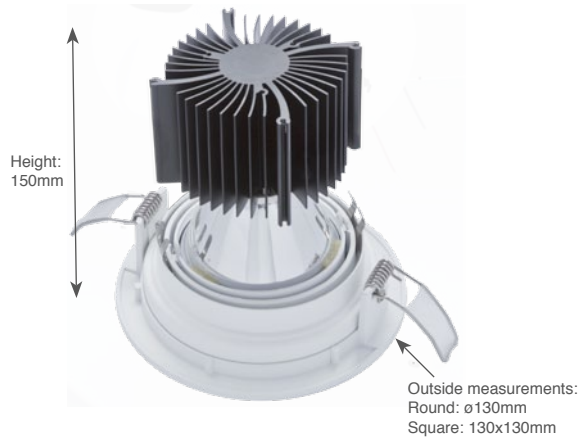
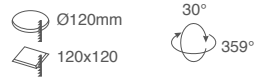

Build-in depth:  
200mm (50mm free space required for ventilation)  
Do not topload with isolation materials!



Included  
LED Drivers included

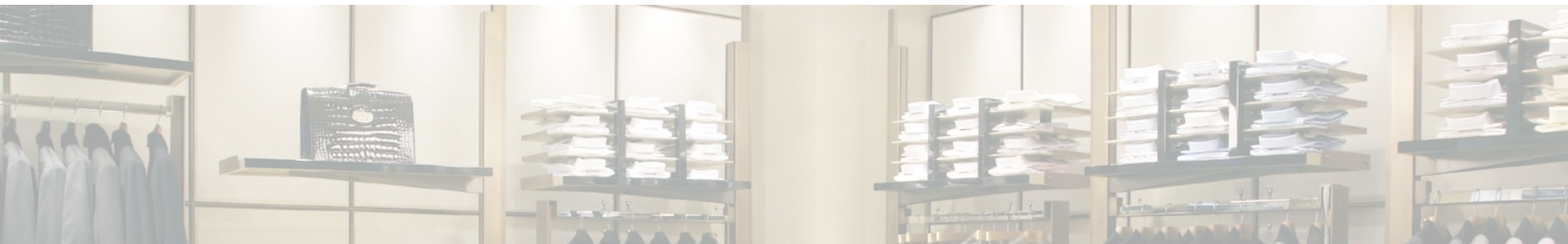

### Kana Round Standard (Passive cooling)

|  |                      |          |  |
|--|----------------------|----------|--|
| <b>Philips Fortimo SLM 2000lm - Non dim.</b>             |                      |          |  |
| Ra80 - 3000K - 17.4W - 119-104lm/W                       | 484.2000.AA.830.01-C | € 151.00 |  |
| Ra80 - 4000K - 17.4W - 126-110lm/W                       | 484.2000.AA.840.01-C | € 151.00 |  |
| Ra90 - 3000K - 17.4W - 97-84lm/W                         | 484.2000.AA.930.01-C | € 151.00 |  |
| Ra90 - 4000K - 17.4W - 104-91lm/W                        | 484.2000.AA.940.01-C | € 151.00 |  |
| <b>Philips Fortimo SLM 2000lm - Touch DIM &amp; DALI</b> |                      |          |  |
| Ra80 - 3000K - 17.4W - 119-104lm/W                       | 484.2000.AA.830.01-D | € 206.00 |  |
| Ra80 - 4000K - 17.4W - 126-110lm/W                       | 484.2000.AA.840.01-D | € 206.00 |  |
| Ra90 - 3000K - 17.4W - 97-84lm/W                         | 484.2000.AA.930.01-D | € 206.00 |  |
| Ra90 - 4000K - 17.4W - 104-91lm/W                        | 484.2000.AA.940.01-D | € 206.00 |  |
| <b>Philips Fortimo SLM 3000lm - Non dim.</b>             |                      |          |  |
| Ra80 - 3000K - 25.9W - 118-103lm/W                       | 484.3000.AA.830.01-C | € 180.00 |  |
| Ra80 - 4000K - 25.9W - 126-110lm/W                       | 484.3000.AA.840.01-C | € 180.00 |  |
| Ra90 - 3000K - 25.9W - 95-83lm/W                         | 484.3000.AA.930.01-C | € 180.00 |  |
| Ra90 - 4000K - 25.9W - 103-90lm/W                        | 484.3000.AA.940.01-C | € 180.00 |  |
| <b>Philips Fortimo SLM 3000lm - Touch DIM &amp; DALI</b> |                      |          |  |
| Ra80 - 3000K - 25.9W - 118-103lm/W                       | 484.3000.AA.830.01-D | € 235.00 |  |
| Ra80 - 4000K - 25.9W - 126-110lm/W                       | 484.3000.AA.840.01-D | € 235.00 |  |
| Ra90 - 3000K - 25.9W - 95-83lm/W                         | 484.3000.AA.930.01-D | € 235.00 |  |
| Ra90 - 4000K - 25.9W - 103-90lm/W                        | 484.3000.AA.940.01-D | € 235.00 |  |

**LED vs. system efficacy**  
 Ra00 - 0000K - 00.0W - 000-000lm/W  
 LED efficacy — System efficacy

**Available beam angles:** 000.0000.AA.000.00-0  
**24:** 24° Reflector  
**36:** 36° Reflector



### Kana Square Standard (Passive cooling)

|  |                      |          |  |
|--|----------------------|----------|--|
| <b>Philips Fortimo SLM 2000lm - Non dim.</b>             |                      |          |  |
| Ra80 - 3000K - 17.4W - 119-104lm/W                       | 449.2000.AA.830.01-C | € 151.00 |  |
| Ra80 - 4000K - 17.4W - 126-110lm/W                       | 449.2000.AA.840.01-C | € 151.00 |  |
| Ra90 - 3000K - 17.4W - 97-84lm/W                         | 449.2000.AA.930.01-C | € 151.00 |  |
| Ra90 - 4000K - 17.4W - 104-91lm/W                        | 449.2000.AA.940.01-C | € 151.00 |  |
| <b>Philips Fortimo SLM 2000lm - Touch DIM &amp; DALI</b> |                      |          |  |
| Ra80 - 3000K - 17.4W - 119-104lm/W                       | 449.2000.AA.830.01-D | € 206.00 |  |
| Ra80 - 4000K - 17.4W - 126-110lm/W                       | 449.2000.AA.840.01-D | € 206.00 |  |
| Ra90 - 3000K - 17.4W - 97-84lm/W                         | 449.2000.AA.930.01-D | € 206.00 |  |
| Ra90 - 4000K - 17.4W - 104-91lm/W                        | 449.2000.AA.940.01-D | € 206.00 |  |
| <b>Philips Fortimo SLM 3000lm - Non dim.</b>             |                      |          |  |
| Ra80 - 3000K - 25.9W - 118-103lm/W                       | 449.3000.AA.830.01-C | € 180.00 |  |
| Ra80 - 4000K - 25.9W - 126-110lm/W                       | 449.3000.AA.840.01-C | € 180.00 |  |
| Ra90 - 3000K - 25.9W - 95-83lm/W                         | 449.3000.AA.930.01-C | € 180.00 |  |
| Ra90 - 4000K - 25.9W - 103-90lm/W                        | 449.3000.AA.940.01-C | € 180.00 |  |
| <b>Philips Fortimo SLM 3000lm - Touch DIM &amp; DALI</b> |                      |          |  |
| Ra80 - 3000K - 25.9W - 118-103lm/W                       | 449.3000.AA.830.01-D | € 235.00 |  |
| Ra80 - 4000K - 25.9W - 126-110lm/W                       | 449.3000.AA.840.01-D | € 235.00 |  |
| Ra90 - 3000K - 25.9W - 95-83lm/W                         | 449.3000.AA.930.01-D | € 235.00 |  |
| Ra90 - 4000K - 25.9W - 103-90lm/W                        | 449.3000.AA.940.01-D | € 235.00 |  |

**Available colors:** 000.0000.000.00.xx-0  
**01:** Matt White Texture  
 Black, grey or other RAL colors on request!!!

# Kana

## Professional Color

Type Recessed  
 Material Aluminium  
 Lamp Orientation Orientable

### LED - Philips Fortimo SLM Active

LED incl.  
 Driver incl.  
 Power 33.7W / 42.3W / 42.3W  
 Lm output 3000 / 2750 / 2960  
 Cooling Active (fan)  
 Color Temp. 3000K / 2600K / 3100K  
 CRI Ra80 / Ra90  
 Color spec. Crisp white / Food / Meat  
 SDCM 3  
 Lifetime 50.000 Hrs (70%)

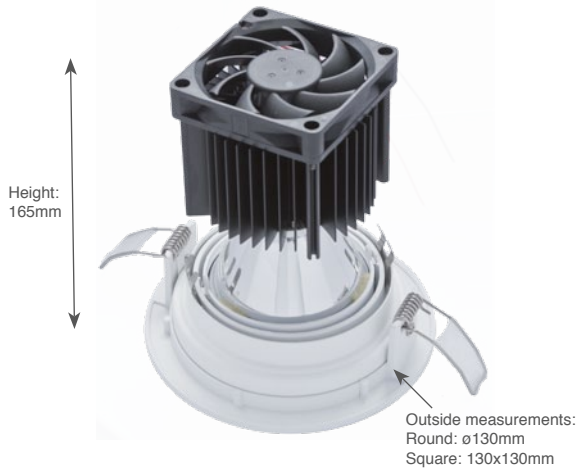
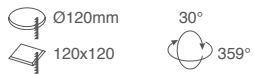

Build-in depth:  
 Active: 265mm (100mm free space required for ventilation)  
 Do not topload with isolation materials!



### Color specs

|  | Color Temp. | CRI (Ra) | R9  | X     | Y     |
|--|-------------|----------|-----|-------|-------|
| <b>Philips Fortimo SLM Crisp White</b> | 3000K       | 90       | ≥50 | 0.430 | 0.395 |
| <b>Philips Fortimo SLM Food</b>        | 2600K       | 90       | ≥70 | 0.450 | 0.380 |
| <b>Philips Fortimo SLM Meat</b>        | 3100K       | 90       | ≥50 | 0.396 | 0.333 |

### Included

LED Drivers included





Active cooling

### Kana Round

Professional color (Active cooling)

- Philips Fortimo SLM Crisp White 3000lm\***
- Non dim. - 33.7W - 88-77lm/W 484.3000.AA.CW.01-C € 204.00
- DALI dim. - 33.7W - 88-77lm/W 484.3000.AA.CW.01-D € 259.00
- Philips Fortimo SLM Food 2750lm\***
- DALI dim. - 42.3W - 65-56lm/W 484.2750.AA.F.01-D € 305.00
- Non dim. version available 4th quarter of 2014
- Philips Fortimo SLM Meat 2960lm\***
- DALI dim. - 42.3W - 70-61lm/W 484.2960.AA.M.01-D € 305.00
- Non dim. version available 4th quarter of 2014



Active cooling

### Kana Square

Professional color (Active cooling)

- Philips Fortimo SLM Crisp White 3000lm\***
- Non dim. - 33.7W - 88-77lm/W 449.3000.AA.CW.01-C € 204.00
- DALI dim. - 33.7W - 88-77lm/W 449.3000.AA.CW.01-D € 259.00
- Philips Fortimo SLM Food 2750lm\***
- DALI dim. - 42.3W - 65-56lm/W 449.2750.AA.F.01-D € 305.00
- Non dim. version available 4th quarter of 2014
- Philips Fortimo SLM Meat 2960lm\***
- DALI dim. - 42.3W - 70-61lm/W 449.2960.AA.M.01-D € 305.00
- Non dim. version available 4th quarter of 2014

\*DALI Dim:  
Dimming is possible by both DALI protocol as  
by using touch dim dimmers.

**LED vs. system efficacy**  
Ra00 - 0000K - 00.0W - 000-000lm/W  
LED efficacy  $\frac{\square}{\square}$  System efficacy

**Available beam angles:** 000.0000.AA.000.00-0  
**24:** 24° Reflector  
**36:** 36° Reflector  
Beam angle  $\frac{\square}{\square}$

**Available colors:** 000.0000.00.00.xx-0  
**01:** Matt White Texture  
Black, grey or other RAL colors on request!!  
color  $\frac{\square}{\square}$

# Kuda Standard

Type Recessed  
 Material Aluminium  
 Lamp Orientation Orientable

## LED - Philips Fortimo SLM Passive

LED incl.  
 Driver incl.  
 Power 18W / 28W  
 Lm output 2000 / 3000  
 Cooling 2000lm: Passive (no fan)  
 3000lm: Passive (no fan)  
 Color Temp. 3000K / 4000K  
 CRI Ra80 / Ra90  
 SDCM 3  
 Lifetime 50.000 Hrs (70%)



Outside measurements:  
 Round:  $\phi$ 120mm  
 Square: 120x120mm

Build-in depth:  
 Passive: 165mm (50mm free space required for ventilation)  
 Do not topload with isolation materials!



Included  
 LED Drivers included

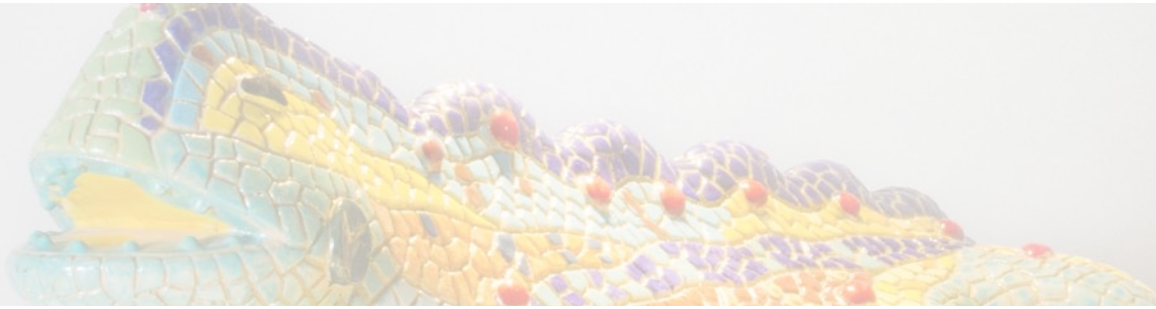

Passive cooling

### Kuda Round

Standard (Passive cooling)

|  |                      |          |  |
|--|----------------------|----------|--|
| <b>Philips Fortimo SLM 2000lm - Non dim.</b>             |                      |          |  |
| Ra80 - 3000K - 17.4W - 119-104lm/W                       | 487.2000.AA.830.xx-C | € 151.00 |  |
| Ra80 - 4000K - 17.4W - 126-110lm/W                       | 487.2000.AA.840.xx-C | € 151.00 |  |
| Ra90 - 3000K - 17.4W - 97-84lm/W                         | 487.2000.AA.930.xx-C | € 151.00 |  |
| Ra90 - 4000K - 17.4W - 104-91lm/W                        | 487.2000.AA.940.xx-C | € 151.00 |  |
| <b>Philips Fortimo SLM 2000lm - Touch DIM &amp; DALI</b> |                      |          |  |
| Ra80 - 3000K - 17.4W - 119-104lm/W                       | 487.2000.AA.830.xx-D | € 206.00 |  |
| Ra80 - 4000K - 17.4W - 126-110lm/W                       | 487.2000.AA.840.xx-D | € 206.00 |  |
| Ra90 - 3000K - 17.4W - 97-84lm/W                         | 487.2000.AA.930.xx-D | € 206.00 |  |
| Ra90 - 4000K - 17.4W - 104-91lm/W                        | 487.2000.AA.940.xx-D | € 206.00 |  |
| <b>Philips Fortimo SLM 3000lm - Non dim.</b>             |                      |          |  |
| Ra80 - 3000K - 25.9W - 118-103lm/W                       | 487.3000.AA.830.xx-C | € 180.00 |  |
| Ra80 - 4000K - 25.9W - 126-110lm/W                       | 487.3000.AA.840.xx-C | € 180.00 |  |
| Ra90 - 3000K - 25.9W - 95-83lm/W                         | 487.3000.AA.930.xx-C | € 180.00 |  |
| Ra90 - 4000K - 25.9W - 103-90lm/W                        | 487.3000.AA.940.xx-C | € 180.00 |  |
| <b>Philips Fortimo SLM 3000lm - Touch DIM &amp; DALI</b> |                      |          |  |
| Ra80 - 3000K - 25.9W - 118-103lm/W                       | 487.3000.AA.830.xx-D | € 235.00 |  |
| Ra80 - 4000K - 25.9W - 126-110lm/W                       | 487.3000.AA.840.xx-D | € 235.00 |  |
| Ra90 - 3000K - 25.9W - 95-83lm/W                         | 487.3000.AA.930.xx-D | € 235.00 |  |
| Ra90 - 4000K - 25.9W - 103-90lm/W                        | 487.3000.AA.940.xx-D | € 235.00 |  |

#### LED vs. system efficacy

Ra00 - 0000K - 00.0W - 000-000lm/W

|              |     |                 |
|--------------|-----|-----------------|
| LED efficacy | └─┘ | System efficacy |
|--------------|-----|-----------------|

#### Available beam angles: 000.0000.AA.000.00-0

24: 24° Reflector  
36: 36° Reflector

|  |     |            |
|--|-----|------------|
|  | └─┘ | Beam angle |
|--|-----|------------|

#### Available colors: 0000.0000.00.xx

01: Matt White Texture  
06: Aluminium Anodised

|  |     |       |
|--|-----|-------|
|  | └─┘ | color |
|--|-----|-------|

Other RAL colors on request!!



Passive cooling

### Kuda Square

Standard (Passive cooling)

|  |                      |          |  |
|--|----------------------|----------|--|
| <b>Philips Fortimo SLM 2000lm - Non dim.</b>             |                      |          |  |
| Ra80 - 3000K - 17.4W - 119-104lm/W                       | 496.2000.AA.830.xx-C | € 151.00 |  |
| Ra80 - 4000K - 17.4W - 126-110lm/W                       | 496.2000.AA.840.xx-C | € 151.00 |  |
| Ra90 - 3000K - 17.4W - 97-84lm/W                         | 496.2000.AA.930.xx-C | € 151.00 |  |
| Ra90 - 4000K - 17.4W - 104-91lm/W                        | 496.2000.AA.940.xx-C | € 151.00 |  |
| <b>Philips Fortimo SLM 2000lm - Touch DIM &amp; DALI</b> |                      |          |  |
| Ra80 - 3000K - 17.4W - 119-104lm/W                       | 496.2000.AA.830.xx-D | € 206.00 |  |
| Ra80 - 4000K - 17.4W - 126-110lm/W                       | 496.2000.AA.840.xx-D | € 206.00 |  |
| Ra90 - 3000K - 17.4W - 97-84lm/W                         | 496.2000.AA.930.xx-D | € 206.00 |  |
| Ra90 - 4000K - 17.4W - 104-91lm/W                        | 496.2000.AA.940.xx-D | € 206.00 |  |
| <b>Philips Fortimo SLM 3000lm - Non dim.</b>             |                      |          |  |
| Ra80 - 3000K - 25.9W - 118-103lm/W                       | 496.3000.AA.830.xx-C | € 180.00 |  |
| Ra80 - 4000K - 25.9W - 126-110lm/W                       | 496.3000.AA.840.xx-C | € 180.00 |  |
| Ra90 - 3000K - 25.9W - 95-83lm/W                         | 496.3000.AA.930.xx-C | € 180.00 |  |
| Ra90 - 4000K - 25.9W - 103-90lm/W                        | 496.3000.AA.940.xx-C | € 180.00 |  |
| <b>Philips Fortimo SLM 3000lm - Touch DIM &amp; DALI</b> |                      |          |  |
| Ra80 - 3000K - 25.9W - 118-103lm/W                       | 496.3000.AA.830.xx-D | € 235.00 |  |
| Ra80 - 4000K - 25.9W - 126-110lm/W                       | 496.3000.AA.840.xx-D | € 235.00 |  |
| Ra90 - 3000K - 25.9W - 95-83lm/W                         | 496.3000.AA.930.xx-D | € 235.00 |  |
| Ra90 - 4000K - 25.9W - 103-90lm/W                        | 496.3000.AA.940.xx-D | € 235.00 |  |



# Kuda Professional Color

Type Recessed  
 Material Aluminium  
 Lamp Orientation Orientable

## LED - Philips Fortimo SLM Active

LED incl.  
 Driver incl.  
 Power 33.7W / 42.3W / 42.3W  
 Lm output 3000 / 2750 / 2960  
 Cooling Active (fan)  
 Color Temp. 2600K / 3100K  
 CRI Ra80 / Ra90  
 Color spec. Crisp white / Food / Meat  
 SDCM 3  
 Lifetime 50.000 Hrs (70%)

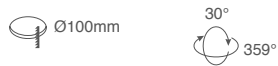

Outside measurements:  
 Round:  $\phi$ 120mm  
 Square: 120x120mm

Build-in depth:  
 Active: 230mm (100mm free space required for ventilation)  
 Do not topload with isolation materials!



### Color specs

|  | Color Temp. | CRI (Ra) | R9        | X     | Y     |
|--|-------------|----------|-----------|-------|-------|
| <b>Philips Fortimo SLM Crisp White</b> | 3000K       | 90       | $\geq 50$ | 0.430 | 0.395 |
| <b>Philips Fortimo SLM Food</b>        | 2600K       | 90       | $\geq 70$ | 0.450 | 0.380 |
| <b>Philips Fortimo SLM Meat</b>        | 3100K       | 90       | $\geq 50$ | 0.396 | 0.333 |

### Included

LED Drivers included



Active cooling

## Kuda Round

Professional color (Active cooling)

### Philips Fortimo SLM Crisp White 3000lm\*

Non dim. - 33.7W - 88-77lm/W 487.3000.**AA.CW.xx-C** € 204.00

DALI dim. - 33.7W - 88-77lm/W 487.3000.**AA.CW.xx-D** € 259.00

### Philips Fortimo SLM Food 2750lm\*

DALI dim. - 42.3W - 65-56lm/W 487.2750.**AA.F.xx-D** € 305.00

Non dim. version available 4th quarter of 2014

### Philips Fortimo SLM Meat 2960lm\*

DALI dim. - 42.3W - 70-61lm/W 487.2960.**AA.M.xx-D** € 305.00

Non dim. version available 4th quarter of 2014



Active cooling

## Kuda Square

Professional color (Active cooling)

### Philips Fortimo SLM Crisp White 3000lm\*

Non dim. - 33.7W - 88-77lm/W 496.3000.**AA.CW.xx-C** € 204.00

DALI dim. - 33.7W - 88-77lm/W 496.3000.**AA.CW.xx-D** € 259.00

### Philips Fortimo SLM Food 2750lm\*

DALI dim. - 42.3W - 65-56lm/W 496.2750.**AA.F.xx-D** € 305.00

Non dim. version available 4th quarter of 2014

### Philips Fortimo SLM Meat 2960lm\*

DALI dim. - 42.3W - 70-61lm/W 496.2960.**AA.M.xx-D** € 305.00

Non dim. version available 4th quarter of 2014

\*DALI Dim:  
Dimming is possible by both DALI protocol as  
by using touch dim dimmers.

LED vs. system efficacy  
Ra00 - 0000K - 00.0W - 000-000lm/W  
LED efficacy  $\frac{\square}{\square}$  System efficacy

Available beam angles: 000.0000.**AA**.000.00-0  
**24:** 24° Reflector  $\frac{\square}{\square}$  Beam angle  
**36:** 36° Reflector

Available colors: 0000.0000.00.**xx**  
**01:** Matt White Texture  $\frac{\square}{\square}$  color  
**06:** Aluminium Anodised  
Other RAL colors on request!!

# Saturnus

Type Recessed  
 Material Aluminium  
 Lamp Orientation Fixed

## LED - Philips Fortimo SLM Passive

LED incl.  
 Driver incl.  
 Power 18W / 28W  
 Lm output 2000 / 3000  
 Cooling 2000lm: Passive (no fan)  
 3000lm: Passive (no fan)  
 Color Temp. 3000K / 4000K  
 CRI Ra80 / Ra90  
 SDCM 3  
 Lifetime 50.000 Hrs (70%)

## LED - Philips Fortimo SLM Active

LED incl.  
 Driver incl.  
 Power 25.9W / 33.7W / 42.3W  
 Lm output 4500 / 3000 / 2750 / 2960  
 Cooling Active (fan)  
 Color Temp. 3000K / 4000K / 2600K / 3100K  
 CRI Ra80 / Ra90  
 Color spec. Standard / Crisp white / Food / Meat  
 SDCM 3  
 Lifetime 50.000 Hrs (70%)

Ø 153mm

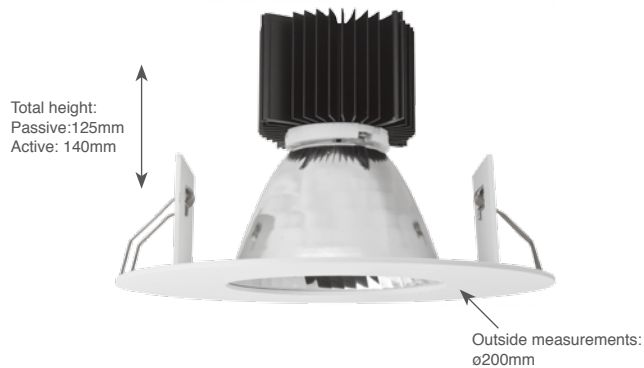

Build-in depth:  
 Passive: 175mm (50mm free space required for ventilation)  
 Active: 240mm (100mm free space required for ventilation)  
 Do not topload with isolation materials!



## Color specs

|  | Color Temp. | CRI (Ra) | R9  | X     | Y     |
|--|-------------|----------|-----|-------|-------|
| <b>Philips Fortimo SLM Crisp White</b> | 3000K       | 90       | ≥50 | 0.430 | 0.395 |
| <b>Philips Fortimo SLM Food</b>        | 2600K       | 90       | ≥70 | 0.450 | 0.380 |
| <b>Philips Fortimo SLM Meat</b>        | 3100K       | 90       | ≥50 | 0.396 | 0.333 |

## Included

LED Drivers included



Passive cooling

## Saturnus

Standard (Passive cooling)

|  |                      |   |        |
|--|----------------------|---|--------|
| <b>Philips Fortimo SLM 2000lm - Non dim.</b>             |                      |   |        |
| Ra80 - 3000K - 17.4W - 119-104lm/W                       | 495.2000.AA.830.01-C | € | 185.00 |
| Ra80 - 4000K - 17.4W - 126-110lm/W                       | 495.2000.AA.840.01-C | € | 185.00 |
| Ra90 - 3000K - 17.4W - 97-84lm/W                         | 495.2000.AA.930.01-C | € | 185.00 |
| Ra90 - 4000K - 17.4W - 104-91lm/W                        | 495.2000.AA.940.01-C | € | 185.00 |
| <b>Philips Fortimo SLM 2000lm - Touch DIM &amp; DALI</b> |                      |   |        |
| Ra80 - 3000K - 17.4W - 119-104lm/W                       | 495.2000.AA.830.01-D | € | 233.00 |
| Ra80 - 4000K - 17.4W - 126-110lm/W                       | 495.2000.AA.840.01-D | € | 233.00 |
| Ra90 - 3000K - 17.4W - 97-84lm/W                         | 495.2000.AA.930.01-D | € | 233.00 |
| Ra90 - 4000K - 17.4W - 104-91lm/W                        | 495.2000.AA.940.01-D | € | 233.00 |
| <b>Philips Fortimo SLM 3000lm - Non dim.</b>             |                      |   |        |
| Ra80 - 3000K - 25.9W - 118-103lm/W                       | 495.3000.AA.830.01-C | € | 210.00 |
| Ra80 - 4000K - 25.9W - 126-110lm/W                       | 495.3000.AA.840.01-C | € | 210.00 |
| Ra90 - 3000K - 25.9W - 95-83lm/W                         | 495.3000.AA.930.01-C | € | 210.00 |
| Ra90 - 4000K - 25.9W - 103-90lm/W                        | 495.3000.AA.940.01-C | € | 210.00 |
| <b>Philips Fortimo SLM 3000lm - Touch DIM &amp; DALI</b> |                      |   |        |
| Ra80 - 3000K - 25.9W - 118-103lm/W                       | 495.3000.AA.830.01-D | € | 258.00 |
| Ra80 - 4000K - 25.9W - 126-110lm/W                       | 495.3000.AA.840.01-D | € | 258.00 |
| Ra90 - 3000K - 25.9W - 95-83lm/W                         | 495.3000.AA.930.01-D | € | 258.00 |
| Ra90 - 4000K - 25.9W - 103-90lm/W                        | 495.3000.AA.940.01-D | € | 258.00 |



Active cooling

## Saturnus

Professional Color (active cooling)

|  |                      |   |        |
|--|----------------------|---|--------|
| <b>Philips Fortimo SLM 4500lm - Non dim.</b>             |                      |   |        |
| Non dim. version available 4th quarter of 2014           |                      |   |        |
| <b>Philips Fortimo SLM 4500lm - Touch DIM &amp; DALI</b> |                      |   |        |
| Ra80 - 3000K - 42W - 115-100lm/W                         | 495.4500.AA.830.01-D | € | 306.00 |
| Ra80 - 4000K - 42W - 123-107lm/W                         | 495.4500.AA.840.01-D | € | 306.00 |
| Ra90 - 3000K - 42W - 93-81lm/W                           | 495.4500.AA.930.01-D | € | 306.00 |
| Ra90 - 4000K - 42W - 101-88lm/W                          | 495.4500.AA.940.01-D | € | 306.00 |
| <b>Philips Fortimo SLM Crisp White 3000lm*</b>           |                      |   |        |
| Non dim. - 33.7W - 88-77lm/W                             | 495.3000.AA.CW.01-C  | € | 230.00 |
| DALI dim. - 33.7W - 88-77lm/W                            | 495.3000.AA.CW.01-D  | € | 278.00 |
| <b>Philips Fortimo SLM Crisp White 3800lm*</b>           |                      |   |        |
| DALI dim. - 42W - 89-77lm/W                              | 495.3800.AA.CW.01-D  | € | 318.00 |
| Non dim. version available 4th quarter of 2014           |                      |   |        |
| <b>Philips Fortimo SLM Food 2750lm*</b>                  |                      |   |        |
| DALI dim. - 42.3W - 65-56lm/W                            | 495.2750.AA.F.01-D   | € | 318.00 |
| Non dim. version available 4th quarter of 2014           |                      |   |        |
| <b>Philips Fortimo SLM Meat 2960lm*</b>                  |                      |   |        |
| DALI dim. - 42.3W - 70-61lm/W                            | 495.2960.AA.M.01-D   | € | 318.00 |
| Non dim. version available 4th quarter of 2014           |                      |   |        |

\*DALI Dim:  
Dimming is possible by both DALI protocol as  
by using touch dim dimmers.

**LED vs. system efficacy**  
Ra00 - 0000K - 00.0W - 000-000lm/W  
LED efficacy  System efficacy

**Available beam angles: 000.0000.AA.000.00-0**  
**16:** 16° Reflector  
**24:** 24° Reflector  
Beam angle

**Available colors: 0000.0000.00.xx**  
**01:** Matt White Texture  
Other RAL colors on request!!  
color

# Titan Trimless Standard

Type Trimless  
Material Aluminium  
Lamp Orientation Orientable

## LED - Bridgelux Vero 10

LED incl.  
Driver to be ordered separately (option)  
Power 9.2W / 350mA  
Color temp. / Lm output  
2700K: 865lm  
3000K: 915lm  
CRI Ra90  
SDCM 3 (2 on request)  
Lifetime 50.000 Hrs (70%)

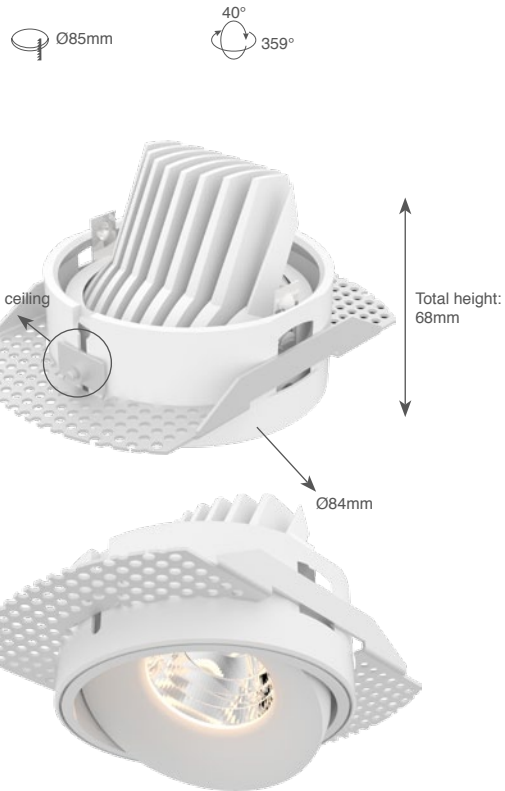

For concrete installation solutions see p.168.

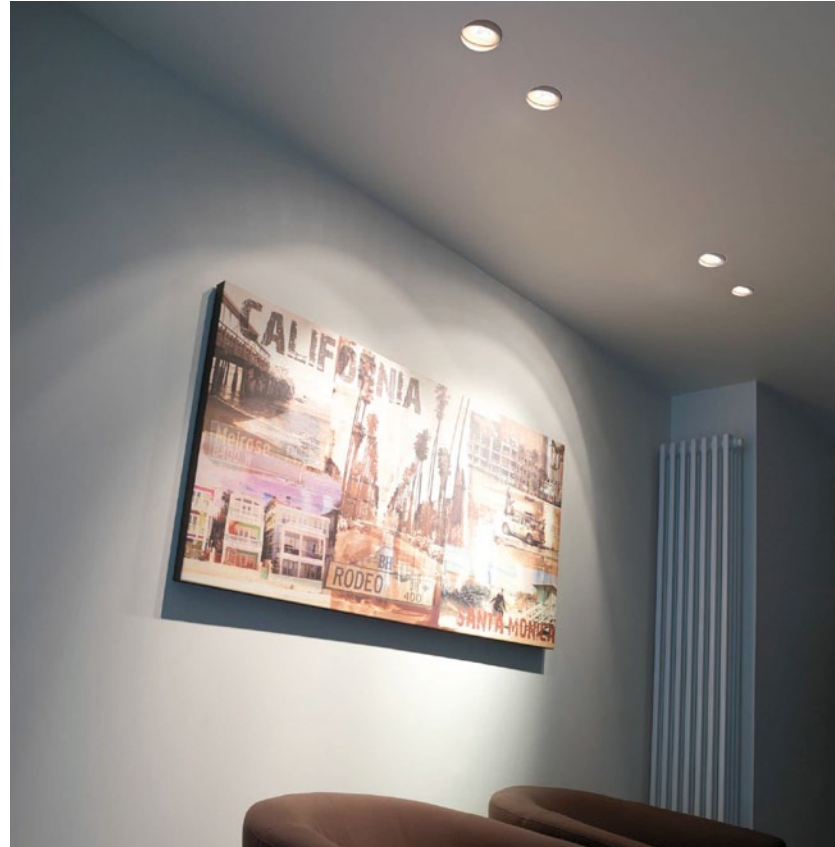

## Options

|                |           |         |
|----------------|-----------|---------|
| Driver non-dim | 490.24.20 | € 26.60 |
| Driver 1-10V   | 490.25.20 | € 43.40 |
| Driver DALI    | 490.26.20 | € 52.10 |

## On Request

LEDs with SDCM 2 (see p.160)  
LEDs with 4000K (see p.160)  
CRI up to Ra97 (see p.160)

Other RAL colors

## Included

Plaster kit



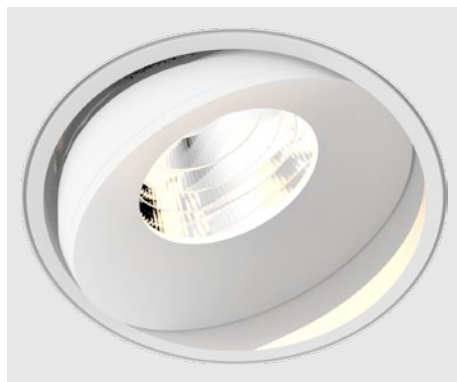
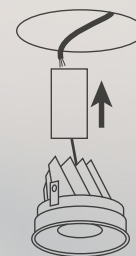
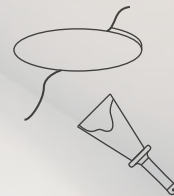
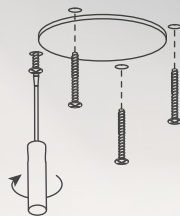

### Titan Trimless Standard Cone

**Bridgelux LED (350mA) + 28° Reflector**  
 2700K 1016.90.2700.28.01 € 125.00  
 3000K 1016.90.3000.28.01 € 125.00

**Bridgelux LED (350mA) + 40° Reflector**  
 2700K 1016.90.2700.40.01 € 125.00  
 3000K 1016.90.3000.40.01 € 125.00



### Titan Trimless Standard Organic

**Bridgelux LED (350mA) + 28° Reflector**  
 2700K 1017.90.2700.28.01 € 125.00  
 3000K 1017.90.3000.28.01 € 125.00



**Bridgelux LED (350mA) + 40° Reflector**  
 2700K 1017.90.2700.40.01 € 125.00  
 3000K 1017.90.3000.40.01 € 125.00



### Titan Trimless Standard Anti-glare

**Bridgelux LED (350mA) + 28° Reflector**  
 2700K 1018.90.2700.28.01 € 135.00  
 3000K 1018.90.3000.28.01 € 135.00

**Bridgelux LED (350mA) + 40° Reflector**  
 2700K 1018.90.2700.40.01 € 135.00  
 3000K 1018.90.3000.40.01 € 135.00

Titan has 3 variants: **Cone**   
**Organic**   
**Anti-glare**   
 More info: p.159

Titan Trimless has 2 different types:  
**Standard:** Luminaire is flush with ceiling  
**Deep:** Luminaire is 16mm recessed into ceiling (next page)  
**Trimless plasterkit included**

Available colors: 0000.00.0000.00.xx  
**01:** Matt White Texture  color  
 Black, grey or other RAL colors on request!!

# Titan Trimless Deep

Type Trimless  
Material Aluminium  
Lamp Orientation Orientable

## LED - Bridgelux Vero 10

LED incl.

Driver to be ordered separately (option)

Power 9.2W / 350mA

Color temp. / Lm output 2700K: 865lm

3000K: 915lm

CRI Ra90

SDCM 3 (2 on request)

Lifetime 50.000 Hrs (70%)

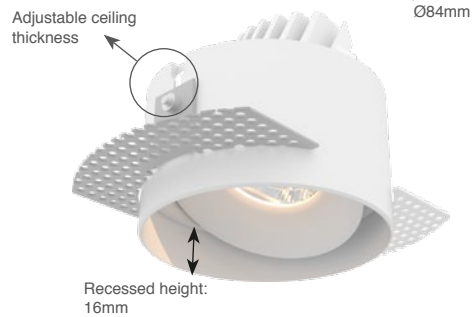
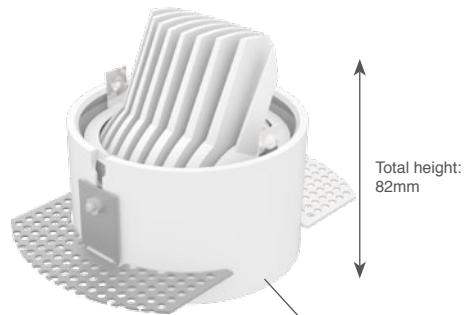

For concrete installation solutions see p.168

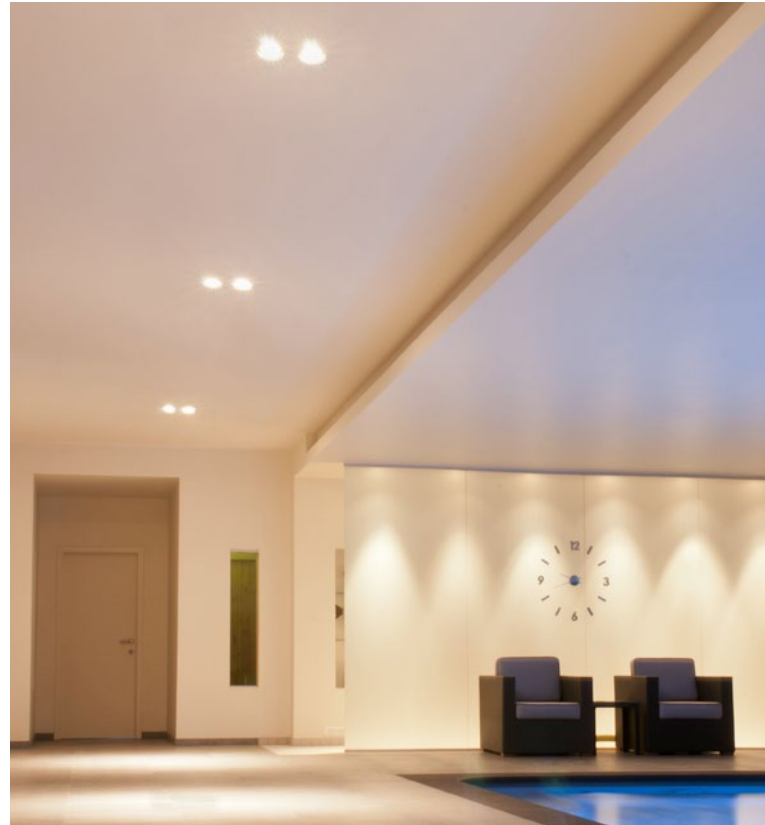

## Options

|                |           |         |
|----------------|-----------|---------|
| Driver non-dim | 490.24.20 | € 26.60 |
| Driver 1-10V   | 490.25.20 | € 43.40 |
| Driver DALI    | 490.26.20 | € 52.10 |

## On Request

LEDs with SDCM 2 (see p.160)

LEDs with 4000K (see p.160)

CRI up to Ra97 (see p.160)

Other RAL colors

## Included

Plaster kit



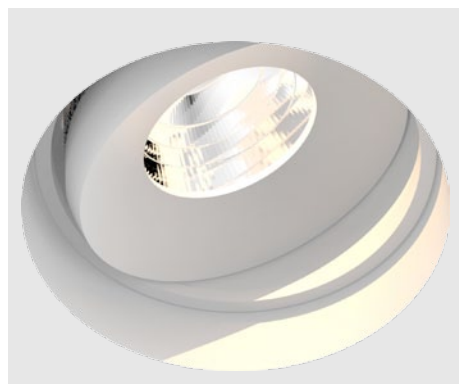
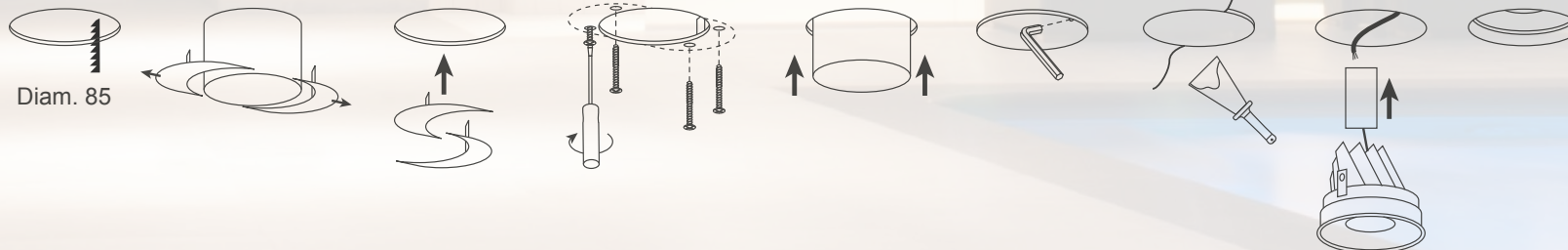

### Titan Trimless Deep Cone

|  |                    |          |
|--|--------------------|----------|
| <b>Bridgelux LED (350mA) + 28° Reflector</b> |                    |          |
| 2700K  | 1019.90.2700.28.01 | € 132.00 |
| 3000K  | 1019.90.3000.28.01 | € 132.00 |

|  |                    |          |
|--|--------------------|----------|
| <b>Bridgelux LED (350mA) + 40° Reflector</b> |                    |          |
| 2700K  | 1019.90.2700.40.01 | € 132.00 |
| 3000K  | 1019.90.3000.40.01 | € 132.00 |

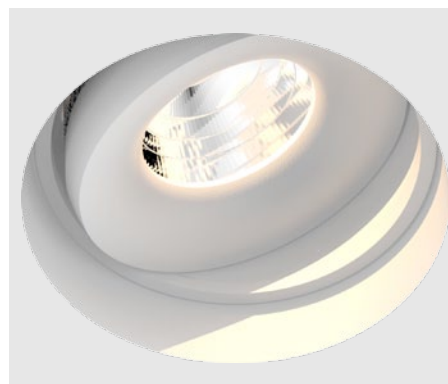

### Titan Trimless Deep Organic

|  |                    |          |
|--|--------------------|----------|
| <b>Bridgelux LED (350mA) + 28° Reflector</b> |                    |          |
| 2700K  | 1020.90.2700.28.01 | € 132.00 |
| 3000K  | 1020.90.3000.28.01 | € 132.00 |

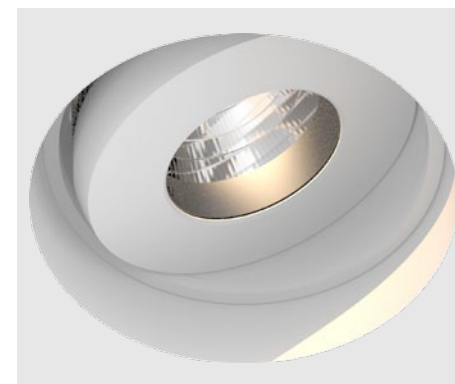

|  |                    |          |
|--|--------------------|----------|
| <b>Bridgelux LED (350mA) + 40° Reflector</b> |                    |          |
| 2700K  | 1020.90.2700.40.01 | € 132.00 |
| 3000K  | 1020.90.3000.40.01 | € 132.00 |



### Titan Trimless Deep Anti-glare

|  |                    |          |
|--|--------------------|----------|
| <b>Bridgelux LED (350mA) + 28° Reflector</b> |                    |          |
| 2700K  | 1021.90.2700.28.01 | € 143.00 |
| 3000K  | 1021.90.3000.28.01 | € 143.00 |

|  |                    |          |
|--|--------------------|----------|
| <b>Bridgelux LED (350mA) + 40° Reflector</b> |                    |          |
| 2700K  | 1021.90.2700.40.01 | € 143.00 |
| 3000K  | 1021.90.3000.40.01 | € 143.00 |

Titan has 3 variants: **Cone**   
**Organic**   
**Anti-glare**   
 More info: p.159

Titan Trimless has 2 different types:  
**Standard:** Luminaire is flush with ceiling (previous page)  
**Deep:** Luminaire is 16mm recessed into ceiling  
**Trimless plasterkit included**

**Available colors:** 0000.00.0000.00.xx  
**01:** Matt White Texture  color  
 Black, grey or other RAL colors on request!!

# Titan Trimless Square

Type Trimless  
Material Aluminium / Fermacell  
Lamp Orientation Orientable

## LED - Bridgelux Vero 10

LED incl.  
Driver to be ordered separately (option)  
Power 9.2W / 350mA  
Coor temp. / Lm output 2700K: 865lm  
3000K: 915lm  
CRI Ra90  
SDCM 3 (2 on request)  
Lifetime 50.000 Hrs (70%)

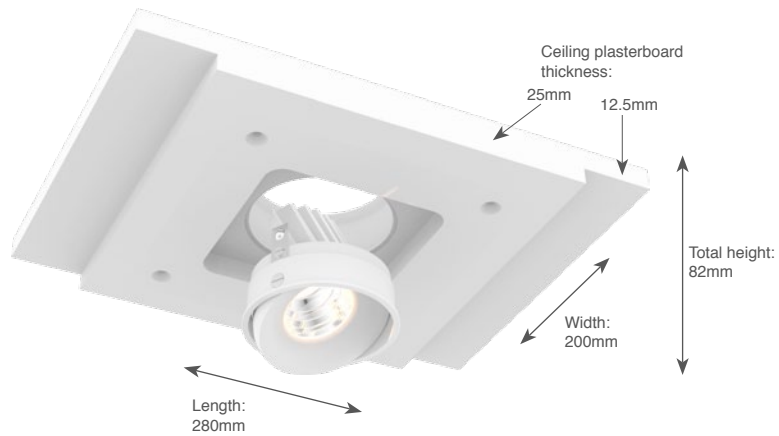
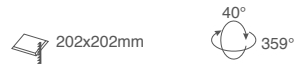

## Options

|                |           |         |
|----------------|-----------|---------|
| Driver non-dim | 490.24.20 | € 26.60 |
| Driver 1-10V   | 490.25.20 | € 43.40 |
| Driver DALI    | 490.26.20 | € 52.10 |

## On Request

LEDs with SDCM 2 (see p.160)  
LEDs with 4000K (see p.160)  
CRI up to Ra97 (see p.160)

Other RAL colors

## Included

Plaster kit (fermacell)

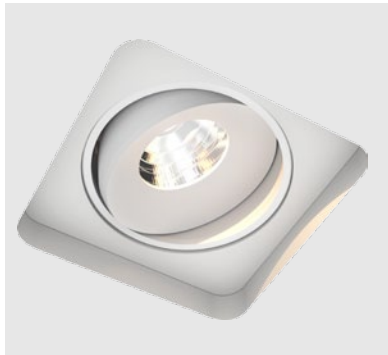
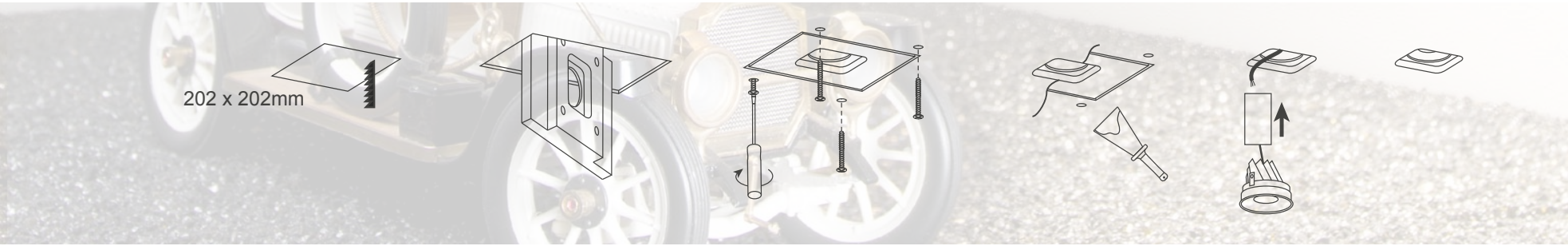

**Titan Trimless Square**  
Cone

|  |                    |          |
|--|--------------------|----------|
| <b>Bridgelux LED (350mA) + 28° Reflector</b> |                    |          |
| 2700K  | 1022.90.2700.28.01 | € 158.00 |
| 3000K  | 1022.90.3000.28.01 | € 158.00 |
| <b>Bridgelux LED (350mA) + 40° Reflector</b> |                    |          |
| 2700K  | 1022.90.2700.40.01 | € 158.00 |
| 3000K  | 1022.90.3000.40.01 | € 158.00 |

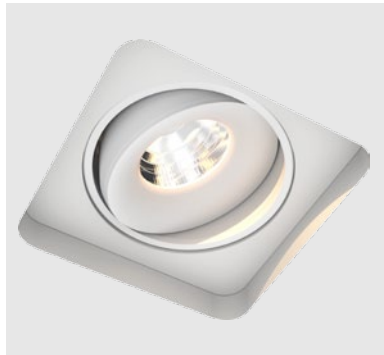

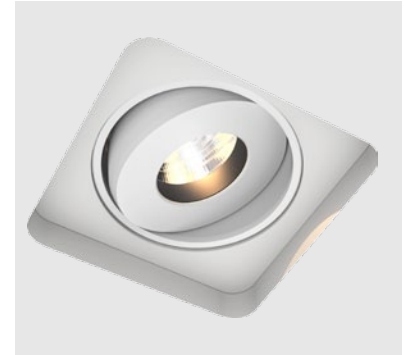

**Titan Trimless Square**  
Organic

|  |                    |          |
|--|--------------------|----------|
| <b>Bridgelux LED (350mA) + 28° Reflector</b> |                    |          |
| 2700K  | 1023.90.2700.28.01 | € 158.00 |
| 3000K  | 1023.90.3000.28.01 | € 158.00 |
| <b>Bridgelux LED (350mA) + 40° Reflector</b> |                    |          |
| 2700K  | 1023.90.2700.40.01 | € 158.00 |
| 3000K  | 1023.90.3000.40.01 | € 158.00 |



**Titan Trimless Square**  
Anti-glare

|  |                    |          |
|--|--------------------|----------|
| <b>Bridgelux LED (350mA) + 28° Reflector</b> |                    |          |
| 2700K  | 1024.90.2700.28.01 | € 166.00 |
| 3000K  | 1024.90.3000.28.01 | € 166.00 |
| <b>Bridgelux LED (350mA) + 40° Reflector</b> |                    |          |
| 2700K  | 1024.90.2700.40.01 | € 166.00 |
| 3000K  | 1024.90.3000.40.01 | € 166.00 |

Titan has 3 variants: Cone   
 Organic   
 Anti-glare   
 More info: p.159

Available colors: 0000.00.0000.00.xx  
 01: Matt White Texture  color  
 Black, grey or other RAL colors on request!!

# Titan Trimless

## Double Square

Type Trimless  
 Material Aluminium / Fermacell  
 Lamp Orientation Orientable

### LED - Bridgelux Vero 10

LED incl.  
 Driver to be ordered separately (option)  
 Power (2x) 9.2W / 350mA  
 Color Temp. / Lm output  
 2700K: (2x) 865lm  
 3000K: (2x) 915lm  
 Ra90  
 SDCM 3 (2 on request)  
 Lifetime 50.000 Hrs (70%)

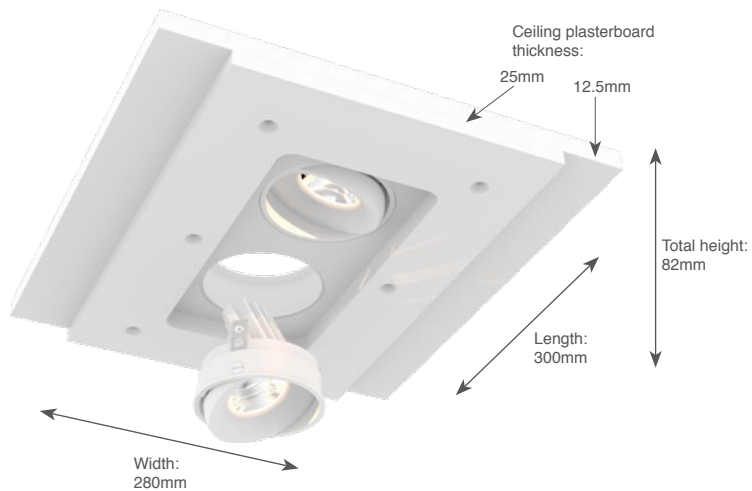
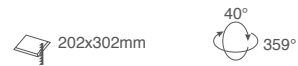

### Options

#### 2 Drivers needed for this luminaire

|                |           |         |
|----------------|-----------|---------|
| Driver non-dim | 490.24.20 | € 26.60 |
| Driver 1-10V   | 490.25.20 | € 43.40 |
| Driver DALI    | 490.26.20 | € 52.10 |

### On Request

LEDs with SDCM 2 (see p.160)  
 LEDs with 4000K (see p.160)  
 CRI up to Ra97 (see p.160)

Other RAL colors

### Included

Plaster kit (fermacell)

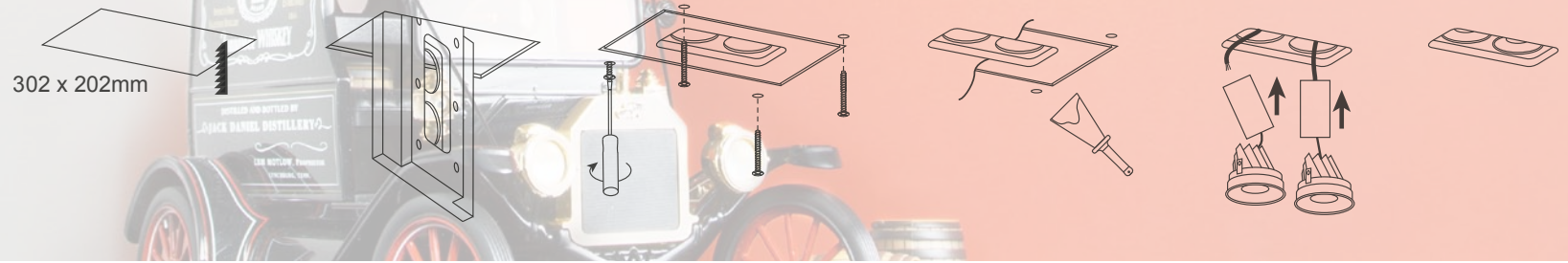

### Titan Trimless Double Square Cone

|  |                    |          |
|--|--------------------|----------|
| <b>Bridgelux LED (350mA) + 28° Reflector</b> |                    |          |
| 2700K  | 1025.90.2700.28.01 | € 261.00 |
| 3000K  | 1025.90.3000.28.01 | € 261.00 |
| <b>Bridgelux LED (350mA) + 40° Reflector</b> |                    |          |
| 2700K  | 1025.90.2700.40.01 | € 261.00 |
| 3000K  | 1025.90.3000.40.01 | € 261.00 |





### Titan Trimless Double Square Organic

|  |                    |          |
|--|--------------------|----------|
| <b>Bridgelux LED (350mA) + 28° Reflector</b> |                    |          |
| 2700K  | 1026.90.2700.28.01 | € 261.00 |
| 3000K  | 1026.90.3000.28.01 | € 261.00 |
| <b>Bridgelux LED (350mA) + 40° Reflector</b> |                    |          |
| 2700K  | 1026.90.2700.40.01 | € 261.00 |
| 3000K  | 1026.90.3000.40.01 | € 261.00 |



### Titan Trimless Double Square Anti-glare

|  |                    |          |
|--|--------------------|----------|
| <b>Bridgelux LED (350mA) + 28° Reflector</b> |                    |          |
| 2700K  | 1027.90.2700.28.01 | € 278.00 |
| 3000K  | 1027.90.3000.28.01 | € 278.00 |
| <b>Bridgelux LED (350mA) + 40° Reflector</b> |                    |          |
| 2700K  | 1027.90.2700.40.01 | € 278.00 |
| 3000K  | 1027.90.3000.40.01 | € 278.00 |

Titan has 3 variants: Cone   
 Organic   
 Anti-glare   
 More info: p.159

Available colors: 0000.00.0000.00.xx  
 01: Matt White Texture  color  
 Black, grey or other RAL colors on request!!



# Many Trimless

Type Trimless  
 Material Aluminium  
 Lamp Orientation Fixed

## LED - Philips Fortimo SLM Passive

LED incl.  
 Driver incl.  
 Power 18W / 28W  
 Lm output 2000 / 3000  
 Lifetime 50.000 Hrs (70%)  
 Cooling 2000lm: Passive (no fan)  
 3000lm: Passive (no fan)

Color Temp. 3000K / 4000K  
 CRI Ra80 / Ra90  
 SDCM 3

## LED - Philips Fortimo SLM Active

LED incl.  
 Driver incl.  
 Power 33.7W / 42.3W / 42.3W  
 Lm output 3000 / 2750 / 2960  
 Cooling Active (fan)  
 Color Temp. 3000K / 4000K / 2600K / 3100K  
 CRI Ra80 / Ra90  
 Color spec. Crisp white / Food / Meat  
 SDCM 3  
 Lifetime 50.000 Hrs (70%)



Height:  
 Passive cooling: 130mm  
 Active cooling: 145mm

Build-in depth:  
 Passive: 180mm (50mm free space required for ventilation)  
 Active: 245mm (100mm free space required for ventilation)  
 Do not topload with isolation materials!



## Color specs

|  | Color Temp. | CRI (Ra) | R9  | X     | Y     |
|--|-------------|----------|-----|-------|-------|
| <b>Philips Fortimo SLM Crisp White</b> | 3000K       | 90       | ≥50 | 0.430 | 0.395 |
| <b>Philips Fortimo SLM Food</b>        | 2600K       | 90       | ≥70 | 0.450 | 0.380 |
| <b>Philips Fortimo SLM Meat</b>        | 3100K       | 90       | ≥50 | 0.396 | 0.333 |

## Included

LED Drivers included

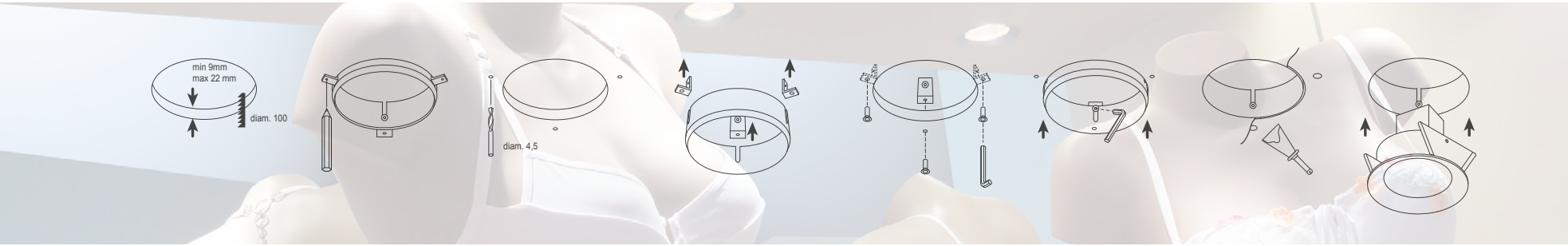

\*DALI Dim:  
Dimming is possible by both DALI protocol as  
by using touch dim dimmers.



Passive cooling

### Many Trimless Standard (Passive cooling)

|  |                      |          |  |
|--|----------------------|----------|--|
| <b>Philips Fortimo SLM 2000lm - Non dim.</b>             |                      |          |  |
| Ra80 - 3000K - 17.4W - 119-104lm/W                       | 443.2000.AA.830.06-C | € 207.00 |  |
| Ra80 - 4000K - 17.4W - 126-110lm/W                       | 443.2000.AA.840.06-C | € 207.00 |  |
| Ra90 - 3000K - 17.4W - 97-84lm/W                         | 443.2000.AA.930.06-C | € 207.00 |  |
| Ra90 - 4000K - 17.4W - 104-91lm/W                        | 443.2000.AA.940.06-C | € 207.00 |  |
| <b>Philips Fortimo SLM 2000lm - Touch DIM &amp; DALI</b> |                      |          |  |
| Ra80 - 3000K - 17.4W - 119-104lm/W                       | 443.2000.AA.830.06-D | € 257.00 |  |
| Ra80 - 4000K - 17.4W - 126-110lm/W                       | 443.2000.AA.840.06-D | € 257.00 |  |
| Ra90 - 3000K - 17.4W - 97-84lm/W                         | 443.2000.AA.930.06-D | € 257.00 |  |
| Ra90 - 4000K - 17.4W - 104-91lm/W                        | 443.2000.AA.940.06-D | € 257.00 |  |
| <b>Philips Fortimo SLM 3000lm - Non dim.</b>             |                      |          |  |
| Ra80 - 3000K - 25.9W - 118-103lm/W                       | 443.3000.AA.830.06-C | € 233.00 |  |
| Ra80 - 4000K - 25.9W - 126-110lm/W                       | 443.3000.AA.840.06-C | € 233.00 |  |
| Ra90 - 3000K - 25.9W - 95-83lm/W                         | 443.3000.AA.930.06-C | € 233.00 |  |
| Ra90 - 4000K - 25.9W - 103-90lm/W                        | 443.3000.AA.940.06-C | € 233.00 |  |
| <b>Philips Fortimo SLM 3000lm - Touch DIM &amp; DALI</b> |                      |          |  |
| Ra80 - 3000K - 25.9W - 118-103lm/W                       | 443.3000.AA.830.06-D | € 283.00 |  |
| Ra80 - 4000K - 25.9W - 126-110lm/W                       | 443.3000.AA.840.06-D | € 283.00 |  |
| Ra90 - 3000K - 25.9W - 95-83lm/W                         | 443.3000.AA.930.06-D | € 283.00 |  |
| Ra90 - 4000K - 25.9W - 103-90lm/W                        | 443.3000.AA.940.06-D | € 283.00 |  |

**LED vs. system efficacy**  
Ra00 - 0000K - 00.0W - 000-000lm/W  
LED efficacy  System efficacy



Active cooling

### Many Trimless Professional color (Active cooling)

|  |                     |          |  |
|--|---------------------|----------|--|
| <b>Philips Fortimo SLM Crisp White 3000lm*</b> |                     |          |  |
| Non dim. - 33.7W - 88-77lm/W                   | 443.3000.AA.CW.06-C | € 255.00 |  |
| DALI dim. - 33.7W - 88-77lm/W                  | 443.3000.AA.CW.06-D | € 305.00 |  |
| <b>Philips Fortimo SLM Food 2750lm*</b>        |                     |          |  |
| DALI dim. - 42.3W - 65-56lm/W                  | 443.2750.AA.F.06-D  | € 347.00 |  |
| Non dim. version available 4th quarter of 2014 |                     |          |  |
| <b>Philips Fortimo SLM Meat 2960lm*</b>        |                     |          |  |
| DALI dim. - 42.3W - 70-61lm/W                  | 443.2960.AA.M.06-D  | € 347.00 |  |
| Non dim. version available 4th quarter of 2014 |                     |          |  |

**Available beam angles:** 000.0000.AA.000.00-0  
**24:** 24° Reflector  Beam angle  
**36:** 36° Reflector

**Available colors:** 0000.0000.00.xx  
**06:** Aluminium Anodised  color



# Collector Trimless Square

|  |                  |
|--|------------------|
| Type                                     | Trimless         |
| Material                                 |                  |
| Lamp Orientation                         | Orientable       |
| <b>QR-111</b>                            |                  |
| Lightsource not incl.                    |                  |
| Transformer not incl.                    |                  |
| Socket                                   | G53              |
| <b>CDM-TC</b>                            |                  |
| Lightsource not incl.                    |                  |
| Ballast not incl.                        |                  |
| Reflector incl.                          |                  |
| Socket                                   | G8.5             |
| <b>CDM-R-111</b>                         |                  |
| Lightsource not incl.                    |                  |
| Ballast not incl.                        |                  |
| Socket                                   | Gx8.5            |
| <b>LED - Philips Fortimo SLM Passive</b> |                  |
| LED incl.                                |                  |
| Driver incl.                             |                  |
| Power                                    | 18W              |
| Lm output                                | 2000             |
| Cooling                                  | Passive (no fan) |
| Color Temp.                              | 3000K / 4000K    |
| CRI                                      | Ra80 / Ra90      |
| SDCM                                     | 3                |
| Lifetime                                 | 50.000 Hrs (70%) |

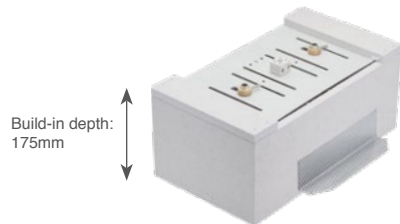
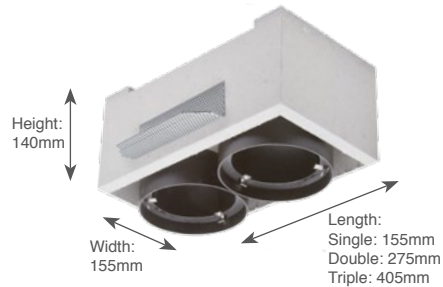

## Options

|                        |           |         |
|------------------------|-----------|---------|
| Electronic Ballast 35W | 490.00.35 | € 52.50 |
| Electronic Ballast 70W | 490.00.70 | € 52.50 |
| Transformer 60VA       | 490.00.60 | € 14.00 |
| Transformer 105VA      | 490.01.05 | € 16.00 |

## Included

Plasterkit (Fermacell)  
LED Drivers included on all LED-luminaires  
Reflector(s) included on CDM-TC luminaires

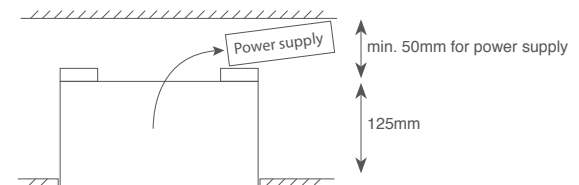



Single: 160 x 160mm  
 Double: 280 x 160mm  
 Triple: 410 x 160mm



## Collector Trimless Square

### Single

|               |             |          |
|---------------|-------------|----------|
| 1x QR-111     | 446.07.xx   | € 86.00  |
| 1x CDM-TC 30° | 446.13.xx-S | € 110.00 |
| 1x CDM-R-111  | 446.14.xx   | € 117.00 |

### 1x Philips Fortimo SLM 2000lm - 24° - Non dim.

|                                    |                      |          |
|------------------------------------|----------------------|----------|
| Ra80 - 3000K - 17.4W - 119-104lm/W | 446.2000.24.830.xx-C | € 196.00 |
| Ra80 - 4000K - 17.4W - 126-110lm/W | 446.2000.24.840.xx-C | € 196.00 |
| Ra90 - 3000K - 17.4W - 97-84lm/W   | 446.2000.24.930.xx-C | € 196.00 |
| Ra90 - 4000K - 17.4W - 104-91lm/W  | 446.2000.24.940.xx-C | € 196.00 |

### 1x Philips Fortimo SLM 2000lm - 36° - Non dim.

|                                    |                      |          |
|------------------------------------|----------------------|----------|
| Ra80 - 3000K - 17.4W - 119-104lm/W | 446.2000.36.830.xx-C | € 196.00 |
| Ra80 - 4000K - 17.4W - 126-110lm/W | 446.2000.36.840.xx-C | € 196.00 |
| Ra90 - 3000K - 17.4W - 97-84lm/W   | 446.2000.36.930.xx-C | € 196.00 |
| Ra90 - 4000K - 17.4W - 104-91lm/W  | 446.2000.36.940.xx-C | € 196.00 |

### 1x Philips Fortimo SLM 2000lm - 24° - Touch DIM & DALI

|                                    |                      |          |
|------------------------------------|----------------------|----------|
| Ra80 - 3000K - 17.4W - 119-104lm/W | 446.2000.24.830.xx-D | € 241.00 |
| Ra80 - 4000K - 17.4W - 126-110lm/W | 446.2000.24.840.xx-D | € 241.00 |
| Ra90 - 3000K - 17.4W - 97-84lm/W   | 446.2000.24.930.xx-D | € 241.00 |
| Ra90 - 4000K - 17.4W - 104-91lm/W  | 446.2000.24.940.xx-D | € 241.00 |

### 1x Philips Fortimo SLM 2000lm - 36° - Touch DIM & DALI

|                                    |                      |          |
|------------------------------------|----------------------|----------|
| Ra80 - 3000K - 17.4W - 119-104lm/W | 446.2000.36.830.xx-D | € 241.00 |
| Ra80 - 4000K - 17.4W - 126-110lm/W | 446.2000.36.840.xx-D | € 241.00 |
| Ra90 - 3000K - 17.4W - 97-84lm/W   | 446.2000.36.930.xx-D | € 241.00 |
| Ra90 - 4000K - 17.4W - 104-91lm/W  | 446.2000.36.940.xx-D | € 241.00 |



## Collector Trimless Square

### Double

|               |             |          |
|---------------|-------------|----------|
| 2x QR-111     | 447.07.xx   | € 119.00 |
| 2x CDM-TC 30° | 447.13.xx-S | € 165.00 |
| 2x CDM-R-111  | 447.14.xx   | € 179.00 |

### 2x Philips Fortimo SLM 2000lm - 24° - Non dim.

|                                      |                      |          |
|--------------------------------------|----------------------|----------|
| Ra80 - 3000K - 2x17.4W - 119-104lm/W | 447.2000.24.830.xx-C | € 324.00 |
| Ra80 - 4000K - 2x17.4W - 126-110lm/W | 447.2000.24.840.xx-C | € 324.00 |
| Ra90 - 3000K - 2x17.4W - 97-84lm/W   | 447.2000.24.930.xx-C | € 324.00 |
| Ra90 - 4000K - 2x17.4W - 104-91lm/W  | 447.2000.24.940.xx-C | € 324.00 |

### 2x Philips Fortimo SLM 2000lm - 36° - Non dim.

|                                      |                      |          |
|--------------------------------------|----------------------|----------|
| Ra80 - 3000K - 2x17.4W - 119-104lm/W | 447.2000.36.830.xx-C | € 324.00 |
| Ra80 - 4000K - 2x17.4W - 126-110lm/W | 447.2000.36.840.xx-C | € 324.00 |
| Ra90 - 3000K - 2x17.4W - 97-84lm/W   | 447.2000.36.930.xx-C | € 324.00 |
| Ra90 - 4000K - 2x17.4W - 104-91lm/W  | 447.2000.36.940.xx-C | € 324.00 |

### 2x Philips Fortimo SLM 2000lm - 24° - Touch DIM & DALI

|                                      |                      |          |
|--------------------------------------|----------------------|----------|
| Ra80 - 3000K - 2x17.4W - 119-104lm/W | 447.2000.24.830.xx-D | € 409.00 |
| Ra80 - 4000K - 2x17.4W - 126-110lm/W | 447.2000.24.840.xx-D | € 409.00 |
| Ra90 - 3000K - 2x17.4W - 97-84lm/W   | 447.2000.24.930.xx-D | € 409.00 |
| Ra90 - 4000K - 2x17.4W - 104-91lm/W  | 447.2000.24.940.xx-D | € 409.00 |

### 2x Philips Fortimo SLM 2000lm - 36° - Touch DIM & DALI

|                                      |                      |          |
|--------------------------------------|----------------------|----------|
| Ra80 - 3000K - 2x17.4W - 119-104lm/W | 447.2000.36.830.xx-D | € 409.00 |
| Ra80 - 4000K - 2x17.4W - 126-110lm/W | 447.2000.36.840.xx-D | € 409.00 |
| Ra90 - 3000K - 2x17.4W - 97-84lm/W   | 447.2000.36.930.xx-D | € 409.00 |
| Ra90 - 4000K - 2x17.4W - 104-91lm/W  | 447.2000.36.940.xx-D | € 409.00 |



## Collector Trimless Square

### Triple

|               |             |          |
|---------------|-------------|----------|
| 3x QR-111     | 448.07.xx   | € 145.00 |
| 3x CDM-TC 30° | 448.13.xx-S | € 215.00 |
| 3x CDM-R-111  | 448.14.xx   | € 235.00 |

### 3x Philips Fortimo SLM 2000lm - 24° - Non dim.

|                                      |                      |          |
|--------------------------------------|----------------------|----------|
| Ra80 - 3000K - 3x17.4W - 119-104lm/W | 448.2000.24.830.xx-C | € 431.00 |
| Ra80 - 4000K - 3x17.4W - 126-110lm/W | 448.2000.24.840.xx-C | € 431.00 |
| Ra90 - 3000K - 3x17.4W - 97-84lm/W   | 448.2000.24.930.xx-C | € 431.00 |
| Ra90 - 4000K - 3x17.4W - 104-91lm/W  | 448.2000.24.940.xx-C | € 431.00 |

### 3x Philips Fortimo SLM 2000lm - 36° - Non dim.

|                                      |                      |          |
|--------------------------------------|----------------------|----------|
| Ra80 - 3000K - 3x17.4W - 119-104lm/W | 448.2000.36.830.xx-C | € 431.00 |
| Ra80 - 4000K - 3x17.4W - 126-110lm/W | 448.2000.36.840.xx-C | € 431.00 |
| Ra90 - 3000K - 3x17.4W - 97-84lm/W   | 448.2000.36.930.xx-C | € 431.00 |
| Ra90 - 4000K - 3x17.4W - 104-91lm/W  | 448.2000.36.940.xx-C | € 431.00 |

### 3x Philips Fortimo SLM 2000lm - 24° - Touch DIM & DALI

|                                      |                      |          |
|--------------------------------------|----------------------|----------|
| Ra80 - 3000K - 3x17.4W - 119-104lm/W | 448.2000.24.830.xx-D | € 551.00 |
| Ra80 - 4000K - 3x17.4W - 126-110lm/W | 448.2000.24.840.xx-D | € 551.00 |
| Ra90 - 3000K - 3x17.4W - 97-84lm/W   | 448.2000.24.930.xx-D | € 551.00 |
| Ra90 - 4000K - 3x17.4W - 104-91lm/W  | 448.2000.24.940.xx-D | € 551.00 |

### 3x Philips Fortimo SLM 2000lm - 36° - Touch DIM & DALI

|                                      |                      |          |
|--------------------------------------|----------------------|----------|
| Ra80 - 3000K - 3x17.4W - 119-104lm/W | 448.2000.36.830.xx-D | € 551.00 |
| Ra80 - 4000K - 3x17.4W - 126-110lm/W | 448.2000.36.840.xx-D | € 551.00 |
| Ra90 - 3000K - 3x17.4W - 97-84lm/W   | 448.2000.36.930.xx-D | € 551.00 |
| Ra90 - 4000K - 3x17.4W - 104-91lm/W  | 448.2000.36.940.xx-D | € 551.00 |

#### LED vs. system efficacy

Ra00 - 0000K - 00.0W - 000-000lm/W

LED efficacy □ System efficacy

#### Available colors: 0000.0000.00. xx

01: Matt White Texture

03: Matt Black Texture

□ color

# Collector Trimless

Type Trimless  
 Material Lamp Orientation Orientable

**QR-111**  
 Lightsource not incl.  
 Transformer not incl.  
 Socket G53

**CDM-TC**  
 Lightsource not incl.  
 Ballast not incl.  
 Reflector incl.  
 Socket G8.5

**CDM-R-111**  
 Lightsource not incl.  
 Ballast not incl.  
 Socket Gx8.5

**LED - Philips Fortimo SLM Passive**  
 LED incl.  
 Driver incl.  
 Power 18W  
 Lm output 2000  
 Cooling Passive (no fan)  
 Color Temp. 3000K / 4000K  
 CRI Ra80 / Ra90  
 SDCM 3  
 Lifetime 50.000 Hrs (70%)

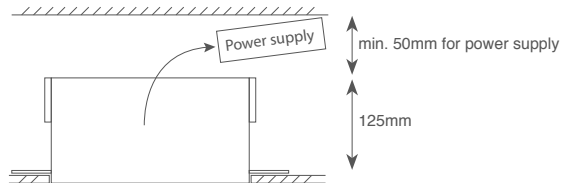
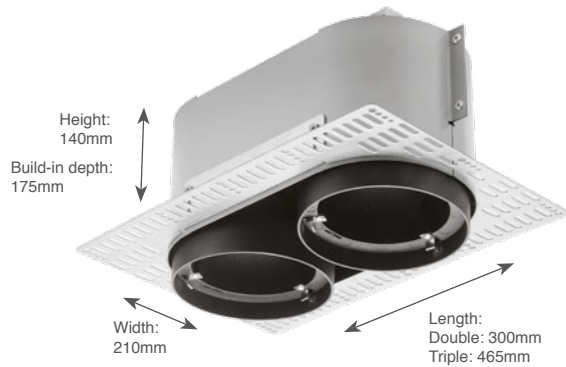

## Options

|                        |           |         |
|------------------------|-----------|---------|
| Electronic Ballast 35W | 490.00.35 | € 52.50 |
| Electronic Ballast 70W | 490.00.70 | € 52.50 |
| Transformer 60VA       | 490.00.60 | € 14.00 |
| Transformer 105VA      | 490.01.05 | € 16.00 |

## Included

LED Drivers included on all LED-luminaires  
 Reflectors included on CDM-TC luminaire

Double: 2x Ø150mm +



Triple: 2x Ø150mm +

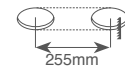

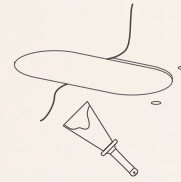
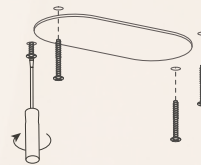
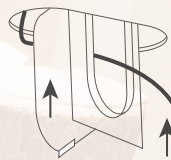
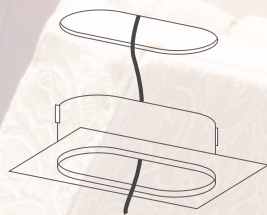
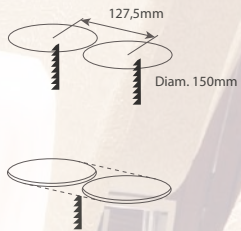

Connect power supplies

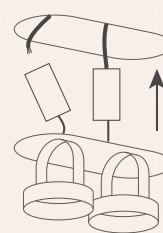

## Collector Trimless

### Double

|               |             |          |
|---------------|-------------|----------|
| 2x QR-111     | 424.07.xx   | € 119.00 |
| 2x CDM-TC 30° | 424.13.xx-S | € 179.00 |
| 2x CDM-R-111  | 424.14.xx   | € 179.00 |

### 2x Philips Fortimo SLM 2000lm - 24° - Non dim.

|                                      |                      |          |
|--------------------------------------|----------------------|----------|
| Ra80 - 3000K - 2x17.4W - 119-104lm/W | 424.2000.24.830.xx-C | € 324.00 |
| Ra80 - 4000K - 2x17.4W - 126-110lm/W | 424.2000.24.840.xx-C | € 324.00 |
| Ra90 - 3000K - 2x17.4W - 97-84lm/W   | 424.2000.24.930.xx-C | € 324.00 |
| Ra90 - 4000K - 2x17.4W - 104-91lm/W  | 424.2000.24.940.xx-C | € 324.00 |

### 2x Philips Fortimo SLM 2000lm - 36° - Non dim.

|                                      |                      |          |
|--------------------------------------|----------------------|----------|
| Ra80 - 3000K - 2x17.4W - 119-104lm/W | 424.2000.36.830.xx-C | € 324.00 |
| Ra80 - 4000K - 2x17.4W - 126-110lm/W | 424.2000.36.840.xx-C | € 324.00 |
| Ra90 - 3000K - 2x17.4W - 97-84lm/W   | 424.2000.36.930.xx-C | € 324.00 |
| Ra90 - 4000K - 2x17.4W - 104-91lm/W  | 424.2000.36.940.xx-C | € 324.00 |

### 2x Philips Fortimo SLM 2000lm - 24° - Touch DIM & DALI

|                                      |                      |          |
|--------------------------------------|----------------------|----------|
| Ra80 - 3000K - 2x17.4W - 119-104lm/W | 424.2000.24.830.xx-D | € 409.00 |
| Ra80 - 4000K - 2x17.4W - 126-110lm/W | 424.2000.24.840.xx-D | € 409.00 |
| Ra90 - 3000K - 2x17.4W - 97-84lm/W   | 424.2000.24.930.xx-D | € 409.00 |
| Ra90 - 4000K - 2x17.4W - 104-91lm/W  | 424.2000.24.940.xx-D | € 409.00 |

### 2x Philips Fortimo SLM 2000lm - 36° - Touch DIM & DALI

|                                      |                      |          |
|--------------------------------------|----------------------|----------|
| Ra80 - 3000K - 2x17.4W - 119-104lm/W | 424.2000.36.830.xx-D | € 409.00 |
| Ra80 - 4000K - 2x17.4W - 126-110lm/W | 424.2000.36.840.xx-D | € 409.00 |
| Ra90 - 3000K - 2x17.4W - 97-84lm/W   | 424.2000.36.930.xx-D | € 409.00 |
| Ra90 - 4000K - 2x17.4W - 104-91lm/W  | 424.2000.36.940.xx-D | € 409.00 |

## Collector Trimless

### Triple

|               |             |          |
|---------------|-------------|----------|
| 3x QR-111     | 425.07.xx   | € 150.00 |
| 3x CDM-TC 30° | 425.13.xx-S | € 221.00 |
| 3x CDM-R-111  | 425.14.xx   | € 221.00 |

### 3x Philips Fortimo SLM 2000lm - 24° - Non dim.

|                                      |                      |          |
|--------------------------------------|----------------------|----------|
| Ra80 - 3000K - 3x17.4W - 119-104lm/W | 425.2000.24.830.xx-C | € 435.00 |
| Ra80 - 4000K - 3x17.4W - 126-110lm/W | 425.2000.24.840.xx-C | € 435.00 |
| Ra90 - 3000K - 3x17.4W - 97-84lm/W   | 425.2000.24.930.xx-C | € 435.00 |
| Ra90 - 4000K - 3x17.4W - 104-91lm/W  | 425.2000.24.940.xx-C | € 435.00 |

### 3x Philips Fortimo SLM 2000lm - 36° - Non dim.

|                                      |                      |          |
|--------------------------------------|----------------------|----------|
| Ra80 - 3000K - 3x17.4W - 119-104lm/W | 425.2000.36.830.xx-C | € 435.00 |
| Ra80 - 4000K - 3x17.4W - 126-110lm/W | 425.2000.36.840.xx-C | € 435.00 |
| Ra90 - 3000K - 3x17.4W - 97-84lm/W   | 425.2000.36.930.xx-C | € 435.00 |
| Ra90 - 4000K - 3x17.4W - 104-91lm/W  | 425.2000.36.940.xx-C | € 435.00 |

### 3x Philips Fortimo SLM 2000lm - 24° - Touch DIM & DALI

|                                      |                      |          |
|--------------------------------------|----------------------|----------|
| Ra80 - 3000K - 3x17.4W - 119-104lm/W | 425.2000.24.830.xx-D | € 556.00 |
| Ra80 - 4000K - 3x17.4W - 126-110lm/W | 425.2000.24.840.xx-D | € 556.00 |
| Ra90 - 3000K - 3x17.4W - 97-84lm/W   | 425.2000.24.930.xx-D | € 556.00 |
| Ra90 - 4000K - 3x17.4W - 104-91lm/W  | 425.2000.24.940.xx-D | € 556.00 |

### 3x Philips Fortimo SLM 2000lm - 36° - Touch DIM & DALI

|                                      |                      |          |
|--------------------------------------|----------------------|----------|
| Ra80 - 3000K - 3x17.4W - 119-104lm/W | 425.2000.36.830.xx-D | € 556.00 |
| Ra80 - 4000K - 3x17.4W - 126-110lm/W | 425.2000.36.840.xx-D | € 556.00 |
| Ra90 - 3000K - 3x17.4W - 97-84lm/W   | 425.2000.36.930.xx-D | € 556.00 |
| Ra90 - 4000K - 3x17.4W - 104-91lm/W  | 425.2000.36.940.xx-D | € 556.00 |

### LED vs. system efficacy

Ra00 - 0000K - 00.0W - 000-000lm/W

LED efficacy □ System efficacy

### Available colors: 0000.0000.00.xx

01: Matt White Texture

03: Matt Black Texture

□color

# Phantom 50

Type Trimless  
Material Aluminium / Plaster  
Lamp Orientation Orientable

## QR-CB51

Lightsource not incl.  
Ballast not incl.  
Power max.50W  
Lamp type MR16  
Socket QR-CB51

## GU10

Lightsource not incl.  
Power max.50  
Socket GU10

1x: 155x155mm  
2x: 285x155mm



Build-in depth:  
150mm (when using a standard spot:  55mm)

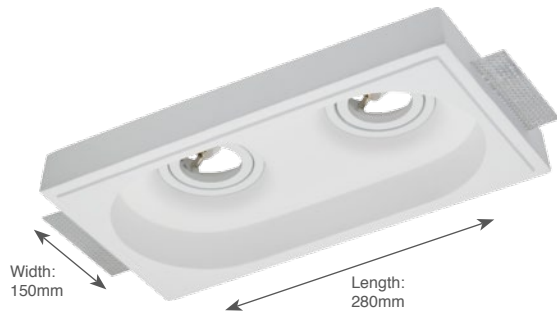
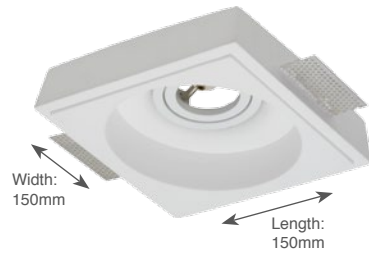

## Included

Plaster kit

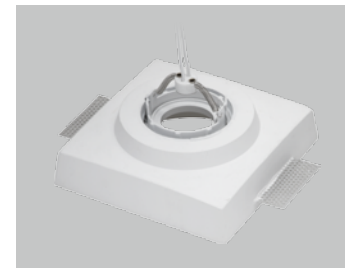





### Phantom 50 Single

|                       |           |         |
|-----------------------|-----------|---------|
| <b>QR-CB51 (MR16)</b> |           |         |
| QR-CB51 socket        | 498.01.00 | € 44.00 |
| <b>GU10</b>           |           |         |
| GU10 socket           | 498.05.00 | € 46.00 |



### Phantom 50 Double

|                          |           |         |
|--------------------------|-----------|---------|
| <b>2x QR-CB51 (MR16)</b> |           |         |
| QR-CB51 socket           | 499.01.00 | € 72.00 |
| <b>2x GU10</b>           |           |         |
| GU10 socket              | 499.05.00 | € 76.00 |



# Phantom 111

Type Trimless  
 Material Aluminium / Plaster  
 Lamp Orientation Orientable

## QR-111

Lightsource not incl.  
 Transformer not incl.  
 Socket G53  
 G8.5

## CDM-R-111

Lightsource not incl.  
 Ballast not incl.  
 Socket Gx8.5

## LED - Philips Fortimo SLM Passive

LED incl.  
 Driver incl.  
 Power 18W / 28W  
 Lm output 2000 / 3000  
 Cooling 2000lm: Passive (no fan)  
 3000lm: Passive (no fan)  
 Color Temp. 3000K / 4000K  
 CRI Ra80 / Ra90  
 SDCM 3  
 Lifetime 50.000 Hrs (70%)

1x: 215x215mm  
 2x: 390x215mm



Build-in depth:  
 AR-111: 95mm  
 CDM-R: 160mm  
 LED SLM: 215mm (50mm free space required for ventilation)



## Options

|                        |           |         |
|------------------------|-----------|---------|
| Electronic Ballast 35W | 490.00.35 | € 52.50 |
| Electronic Ballast 70W | 490.00.70 | € 52.50 |
| Transformer 60VA       | 490.00.60 | € 14.00 |
| Transformer 105VA      | 490.01.05 | € 16.00 |

## Included

Plaster kit  
 LED Drivers included on all LED-Luminaires

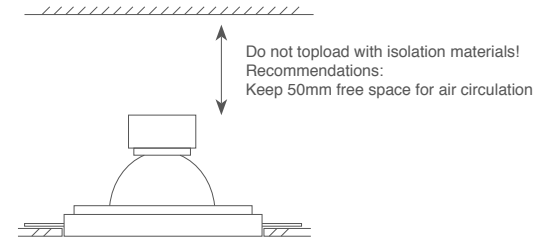

Single: 215 x 215  
Double: 390 x 215mm

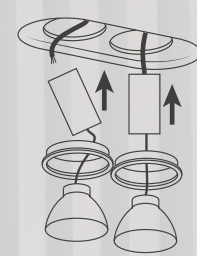
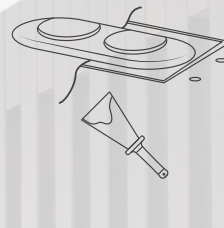
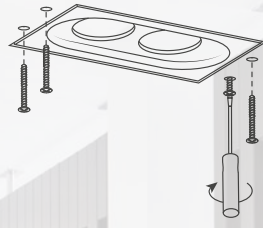
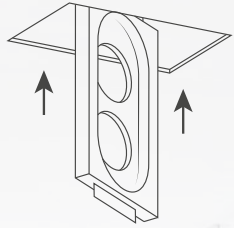

Passive cooling



Passive cooling



### Phantom 111 Single (passive cooling)

|              |           |         |
|--------------|-----------|---------|
| 1x QR-111    | 498.07.00 | € 56.00 |
| 1x CDM-R-111 | 498.14.00 | € 92.00 |

|  |                      |          |
|--|----------------------|----------|
| <b>Philips Fortimo SLM 2000lm - Non dim.</b> |                      |          |
| Ra80 - 3000K - 17.4W - 119-104lm/W           | 498.2000.AA.830.00-C | € 124.00 |
| Ra80 - 4000K - 17.4W - 126-110lm/W           | 498.2000.AA.840.00-C | € 124.00 |
| Ra90 - 3000K - 17.4W - 97-84lm/W             | 498.2000.AA.930.00-C | € 124.00 |
| Ra90 - 4000K - 17.4W - 104-91lm/W            | 498.2000.AA.940.00-C | € 124.00 |

|  |                      |          |
|--|----------------------|----------|
| <b>Philips Fortimo SLM 2000lm - Touch DIM &amp; DALI</b> |                      |          |
| Ra80 - 3000K - 17.4W - 119-104lm/W                       | 498.2000.AA.830.00-D | € 167.00 |
| Ra80 - 4000K - 17.4W - 126-110lm/W                       | 498.2000.AA.840.00-D | € 167.00 |
| Ra90 - 3000K - 17.4W - 97-84lm/W                         | 498.2000.AA.930.00-D | € 167.00 |
| Ra90 - 4000K - 17.4W - 104-91lm/W                        | 498.2000.AA.940.00-D | € 167.00 |

|  |                      |          |
|--|----------------------|----------|
| <b>Philips Fortimo SLM 3000lm - Non dim.</b> |                      |          |
| Ra80 - 3000K - 25.9W - 118-103lm/W           | 498.3000.AA.830.00-C | € 146.00 |
| Ra80 - 4000K - 25.9W - 126-110lm/W           | 498.3000.AA.840.00-C | € 146.00 |
| Ra90 - 3000K - 25.9W - 95-83lm/W             | 498.3000.AA.930.00-C | € 146.00 |
| Ra90 - 4000K - 25.9W - 103-90lm/W            | 498.3000.AA.940.00-C | € 146.00 |

|  |                      |          |
|--|----------------------|----------|
| <b>Philips Fortimo SLM 3000lm - Touch DIM &amp; DALI</b> |                      |          |
| Ra80 - 3000K - 25.9W - 118-103lm/W                       | 498.3000.AA.830.00-D | € 189.00 |
| Ra80 - 4000K - 25.9W - 126-110lm/W                       | 498.3000.AA.840.00-D | € 189.00 |
| Ra90 - 3000K - 25.9W - 95-83lm/W                         | 498.3000.AA.930.00-D | € 189.00 |
| Ra90 - 4000K - 25.9W - 103-90lm/W                        | 498.3000.AA.940.00-D | € 189.00 |

**LED vs. system efficacy**  
Ra00 - 0000K - 00.0W - 000-000lm/W  
LED efficacy | System efficacy

### Phantom 111 Double (passive cooling)

|              |           |          |
|--------------|-----------|----------|
| 2x QR-111    | 499.07.00 | € 105.00 |
| 2x CDM-R-111 | 499.14.00 | € 179.00 |

|   |                      |          |
|---|----------------------|----------|
| <b>2x Philips Fortimo SLM 2000lm - Non dim.</b> |                      |          |
| Ra80 - 3000K - 2x17.4W - 119-104lm/W            | 499.2000.AA.830.00-C | € 245.00 |
| Ra80 - 4000K - 2x17.4W - 126-110lm/W            | 499.2000.AA.840.00-C | € 245.00 |
| Ra90 - 3000K - 2x17.4W - 97-84lm/W              | 499.2000.AA.930.00-C | € 245.00 |
| Ra90 - 4000K - 2x17.4W - 104-91lm/W             | 499.2000.AA.940.00-C | € 245.00 |

|   |                      |          |
|---|----------------------|----------|
| <b>2x Philips Fortimo SLM 2000lm - Touch DIM &amp; DALI</b> |                      |          |
| Ra80 - 3000K - 2x17.4W - 119-104lm/W                        | 499.2000.AA.830.00-D | € 330.00 |
| Ra80 - 4000K - 2x17.4W - 126-110lm/W                        | 499.2000.AA.840.00-D | € 330.00 |
| Ra90 - 3000K - 2x17.4W - 97-84lm/W                          | 499.2000.AA.930.00-D | € 330.00 |
| Ra90 - 4000K - 2x17.4W - 104-91lm/W                         | 499.2000.AA.940.00-D | € 330.00 |

|   |                      |          |
|---|----------------------|----------|
| <b>2x Philips Fortimo SLM 3000lm - Non dim.</b> |                      |          |
| Ra80 - 3000K - 2x125.9W - 118-103lm/W           | 499.3000.AA.830.00-C | € 290.00 |
| Ra80 - 4000K - 2x125.9W - 126-110lm/W           | 499.3000.AA.840.00-C | € 290.00 |
| Ra90 - 3000K - 2x125.9W - 95-83lm/W             | 499.3000.AA.930.00-C | € 290.00 |
| Ra90 - 4000K - 2x125.9W - 103-90lm/W            | 499.3000.AA.940.00-C | € 290.00 |

|   |                      |          |
|---|----------------------|----------|
| <b>2x Philips Fortimo SLM 3000lm - Touch DIM &amp; DALI</b> |                      |          |
| Ra80 - 3000K - 2x125.9W - 118-103lm/W                       | 499.3000.AA.830.00-D | € 375.00 |
| Ra80 - 4000K - 2x125.9W - 126-110lm/W                       | 499.3000.AA.840.00-D | € 375.00 |
| Ra90 - 3000K - 2x125.9W - 95-83lm/W                         | 499.3000.AA.930.00-D | € 375.00 |
| Ra90 - 4000K - 2x125.9W - 103-90lm/W                        | 499.3000.AA.940.00-D | € 375.00 |

**Available beam angles:** 000.0000.AA.000.00-0  
16: 16° Reflector | Beam angle  
24: 24° Reflector

# Phantom 111

Type Trimless  
 Material Aluminium / Plaster  
 Lamp Orientation Orientable

## LED - Philips Fortimo SLM Active

LED incl.  
 Driver incl.  
 Power 25.9W / 33.7W / 42.3W  
 Lm output 4500 / 3000 / 2750 / 2960  
 Cooling Active (fan)  
 Color Temp. 3000K / 4000K / 2600K / 3100K  
 CRI Ra80 / Ra90  
 Color spec. Standard / Crisp white / Food / Meat  
 SDCM 3  
 Lifetime 50.000 Hrs (70%)

1x: 215x215mm  
 2x: 390x215mm  
 Build-in depth: 265mm  

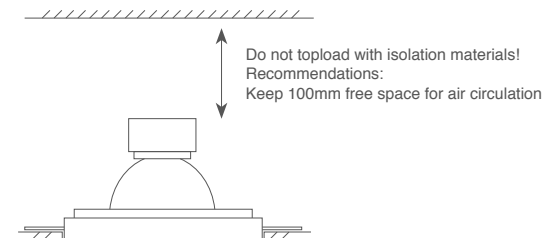
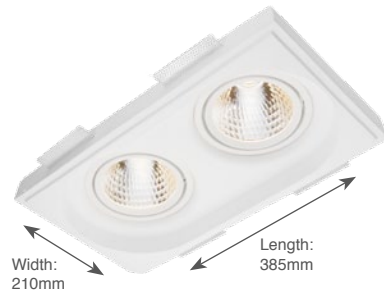
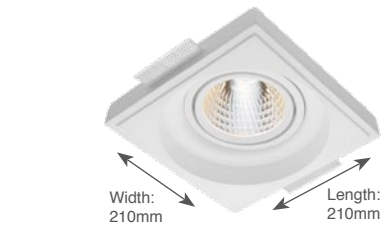
## Color specs

|  | Color Temp. | CRI (Ra) | R9  | X     | Y     |
|--|-------------|----------|-----|-------|-------|
| <b>Philips Fortimo SLM Crisp White</b> | 3000K       | 90       | ≥50 | 0.430 | 0.395 |
| <b>Philips Fortimo SLM Food</b>        | 2600K       | 90       | ≥70 | 0.450 | 0.380 |
| <b>Philips Fortimo SLM Meat</b>        | 3100K       | 90       | ≥50 | 0.396 | 0.333 |

## Included

Plaster kit  
 LED Drivers included on all LED-Luminaires

Single: 215 x 215  
Double: 390 x 215mm

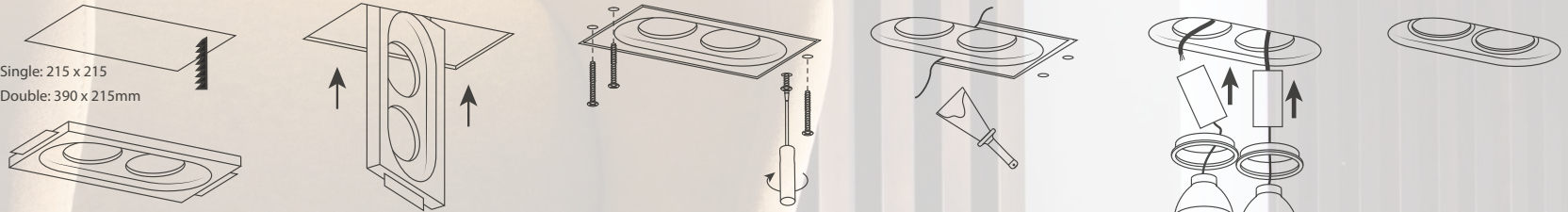

Active cooling



Active cooling

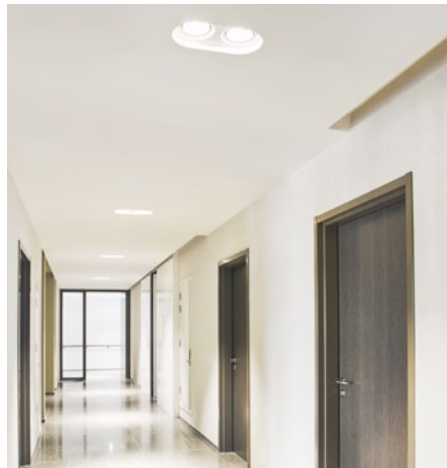

## Phantom 111

Single Professional Color (active cooling)

**Philips Fortimo SLM 4500lm - Non dim.**  
Non dim. version available 4th quarter of 2014

**Philips Fortimo SLM 4500lm - Touch DIM & DALI**

|                                  |                      |          |
|----------------------------------|----------------------|----------|
| Ra80 - 3000K - 42W - 115-100lm/W | 498.4500.AA.830.00-D | € 232.00 |
| Ra80 - 4000K - 42W - 123-107lm/W | 498.4500.AA.840.00-D | € 232.00 |
| Ra90 - 3000K - 42W - 93-81lm/W   | 498.4500.AA.930.00-D | € 232.00 |
| Ra90 - 4000K - 42W - 101-88lm/W  | 498.4500.AA.940.00-D | € 232.00 |

**Philips Fortimo SLM Crisp White 3000lm\***

|                               |                     |          |
|-------------------------------|---------------------|----------|
| Non dim. - 33.7W - 88-77lm/W  | 498.3000.AA.CW.00-C | € 164.00 |
| DALI dim. - 33.7W - 88-77lm/W | 498.3000.AA.CW.00-D | € 207.00 |

**Philips Fortimo SLM Crisp White 3800lm\***

|                             |                     |          |
|-----------------------------|---------------------|----------|
| DALI dim. - 42W - 89-77lm/W | 498.3800.AA.CW.00-D | € 243.00 |
|-----------------------------|---------------------|----------|

Non dim. version available 4th quarter of 2014

**Philips Fortimo SLM Food 2750lm\***

|                               |                    |          |
|-------------------------------|--------------------|----------|
| DALI dim. - 42.3W - 65-56lm/W | 498.2750.AA.F.00-D | € 243.00 |
|-------------------------------|--------------------|----------|

Non dim. version available 4th quarter of 2014

**Philips Fortimo SLM Meat 2960lm\***

|                               |                    |          |
|-------------------------------|--------------------|----------|
| DALI dim. - 42.3W - 70-61lm/W | 498.2960.AA.M.00-D | € 243.00 |
|-------------------------------|--------------------|----------|

Non dim. version available 4th quarter of 2014

**LED vs. system efficacy**  
Ra00 - 0000K - 00.0W - 000-000lm/W

LED efficacy | System efficacy

## Phantom 111

Double Professional Color (active cooling)

**2x Philips Fortimo SLM 4500lm - Non dim.**  
Non dim. version available 4th quarter of 2014

**2x Philips Fortimo SLM 4500lm - Touch DIM & DALI**

|                                    |                      |          |
|------------------------------------|----------------------|----------|
| Ra80 - 3000K - 2x42W - 115-100lm/W | 499.4500.AA.830.00-D | € 460.00 |
| Ra80 - 4000K - 2x42W - 123-107lm/W | 499.4500.AA.840.00-D | € 460.00 |
| Ra90 - 3000K - 2x42W - 93-81lm/W   | 499.4500.AA.930.00-D | € 460.00 |
| Ra90 - 4000K - 2x42W - 101-88lm/W  | 499.4500.AA.940.00-D | € 460.00 |

**2x Philips Fortimo SLM Crisp White 3000lm\***

|                                 |                     |          |
|---------------------------------|---------------------|----------|
| Non dim. - 2x33.7W - 88-77lm/W  | 499.3000.AA.CW.00-C | € 326.00 |
| DALI dim. - 2x33.7W - 88-77lm/W | 499.3000.AA.CW.00-D | € 411.00 |

**2x Philips Fortimo SLM Crisp White 3800lm\***

|                               |                     |          |
|-------------------------------|---------------------|----------|
| DALI dim. - 2x42W - 89-77lm/W | 499.3800.AA.CW.00-D | € 483.00 |
|-------------------------------|---------------------|----------|

Non dim. version available 4th quarter of 2014

**2x Philips Fortimo SLM Food 2750lm\***

|                                 |                    |          |
|---------------------------------|--------------------|----------|
| DALI dim. - 2x42.3W - 65-56lm/W | 499.2750.AA.F.00-D | € 483.00 |
|---------------------------------|--------------------|----------|

Non dim. version available 4th quarter of 2014

**2x Philips Fortimo SLM Meat 2960lm\***

|                                 |                    |          |
|---------------------------------|--------------------|----------|
| DALI dim. - 2x42.3W - 70-61lm/W | 499.2960.AA.M.00-D | € 483.00 |
|---------------------------------|--------------------|----------|

Non dim. version available 4th quarter of 2014

**Available beam angles:** 000.0000.AA.000.00-0

16: 16° Reflector

24: 24° Reflector

Beam angle



# Suspended / Surface Mounted

## Surface Mounted

### Titan

|                             |    |
|-----------------------------|----|
| Titan Semi-Recessed .....   | 82 |
| Titan Surface Mounted ..... | 84 |
| Titan Box .....             | 90 |
| Titan Suspended T2 .....    | 94 |
| Titan Arm 2-way .....       | 96 |
| Titan Arm 4-way .....       | 98 |

### Collector

|                     |    |
|---------------------|----|
| Collector Box ..... | 88 |
|---------------------|----|

### Cube/Rondo

|             |    |
|-------------|----|
| Cube .....  | 78 |
| Rondo ..... | 80 |

### Moody

|                     |    |
|---------------------|----|
| Moody Base .....    | 86 |
| Moody 3-Phase ..... | 86 |

## Suspended

### Titan

|                       |    |
|-----------------------|----|
| Titan Box .....       | 90 |
| Titan Suspended ..... | 92 |

### Collector

|                     |    |
|---------------------|----|
| Collector Box ..... | 88 |
|---------------------|----|





# Cube

## Small / Large

|                        |                 |
|------------------------|-----------------|
| Type                   | Surface Mounted |
| Material               | Aluminium       |
| Lamp Orientation Small | Fixed           |
| Lamp Orientation Large | Orientable      |

### GU10

|                       |         |
|-----------------------|---------|
| Lightsource not incl. |         |
| Power                 | max.50W |
| Socket                | GU10    |

### GU10 (6W LED incl.)

|                   |                    |
|-------------------|--------------------|
| Lightsource incl. |                    |
| Lightsource       | Megaman MM3596     |
| Power             | 6W                 |
| Socket            | GU10               |
| Color temp.       | 2800K              |
| Lumen output      | 300lm              |
| Dimmability       | Dimmable (10-100%) |

### LED - Philips Fortimo SLM Passive

|              |                  |
|--------------|------------------|
| LED incl.    |                  |
| Driver incl. |                  |
| Power        | 18W              |
| Lm output    | 2000             |
| Cooling      | Passive (no fan) |
| Color Temp.  | 3000K / 4000K    |
| CRI          | Ra80 / Ra90      |
| SDCM         | 3                |
| Lifetime     | 50.000 Hrs (70%) |

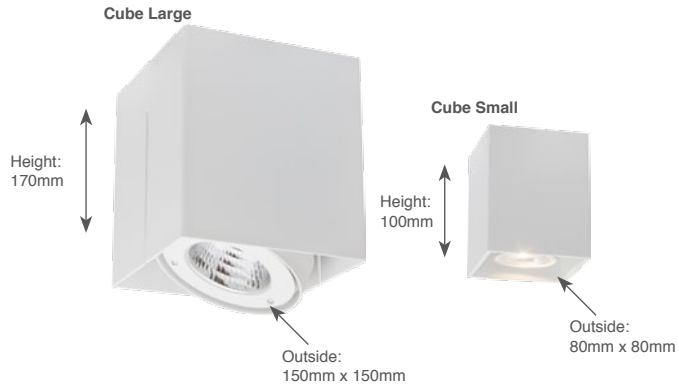

**Included**  
LED Drivers included on all LED-Luminaires

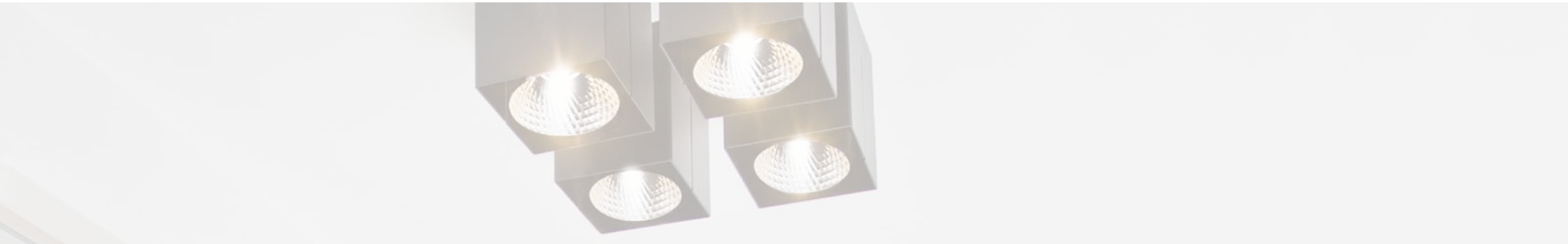

### Cube

Small

|                     |                  |         |
|---------------------|------------------|---------|
| GU10 Socket         | 102.05.xx        | € 75.00 |
| GU10 (6W LED incl.) | 102.05.xx.MM3596 | € 95.00 |



### Cube

Large

|   |                      |          |  |
|---|----------------------|----------|--|
| <b>1x Philips Fortimo SLM 2000lm - 24° - Non dim.</b>             |                      |          |  |
| Ra80 - 3000K - 17.4W - 119-104lm/W                                | 102.2000.24.830.xx-C | € 219.00 |  |
| Ra80 - 4000K - 17.4W - 126-110lm/W                                | 102.2000.24.840.xx-C | € 219.00 |  |
| Ra90 - 3000K - 17.4W - 97-84lm/W                                  | 102.2000.24.930.xx-C | € 219.00 |  |
| Ra90 - 4000K - 17.4W - 104-91lm/W                                 | 102.2000.24.940.xx-C | € 219.00 |  |
| <b>1x Philips Fortimo SLM 2000lm - 36° - Non dim.</b>             |                      |          |  |
| Ra80 - 3000K - 17.4W - 119-104lm/W                                | 102.2000.36.830.xx-C | € 219.00 |  |
| Ra80 - 4000K - 17.4W - 126-110lm/W                                | 102.2000.36.840.xx-C | € 219.00 |  |
| Ra90 - 3000K - 17.4W - 97-84lm/W                                  | 102.2000.36.930.xx-C | € 219.00 |  |
| Ra90 - 4000K - 17.4W - 104-91lm/W                                 | 102.2000.36.940.xx-C | € 219.00 |  |
| <b>1x Philips Fortimo SLM 2000lm - 24° - Touch DIM &amp; DALI</b> |                      |          |  |
| Ra80 - 3000K - 17.4W - 119-104lm/W                                | 102.2000.24.830.xx-D | € 261.00 |  |
| Ra80 - 4000K - 17.4W - 126-110lm/W                                | 102.2000.24.840.xx-D | € 261.00 |  |
| Ra90 - 3000K - 17.4W - 97-84lm/W                                  | 102.2000.24.930.xx-D | € 261.00 |  |
| Ra90 - 4000K - 17.4W - 104-91lm/W                                 | 102.2000.24.940.xx-D | € 261.00 |  |
| <b>1x Philips Fortimo SLM 2000lm - 36° - Touch DIM &amp; DALI</b> |                      |          |  |
| Ra80 - 3000K - 17.4W - 119-104lm/W                                | 102.2000.36.830.xx-D | € 261.00 |  |
| Ra80 - 4000K - 17.4W - 126-110lm/W                                | 102.2000.36.840.xx-D | € 261.00 |  |
| Ra90 - 3000K - 17.4W - 97-84lm/W                                  | 102.2000.36.930.xx-D | € 261.00 |  |
| Ra90 - 4000K - 17.4W - 104-91lm/W                                 | 102.2000.36.940.xx-D | € 261.00 |  |

#### LED vs. system efficacy

|                                    |                 |
|------------------------------------|-----------------|
| Ra00 - 0000K - 00.0W - 000-000lm/W |                 |
| LED efficacy                       | System efficacy |

Available colors: 0000.00.0000.00.xx

01: Matt White Texture  
 Black, grey or other RAL colors on request!!

# Rondo

## Small / Large

Type  
Material  
Lamp Orientation Small  
Lamp Orientation Large

Surface Mounted  
Aluminium  
Fixed  
Orientable

### GU10

Lightsource not incl.  
Power  
Socket

max.50W  
GU10

### GU10 (6W LED incl.)

Lightsource incl.

Lightsource  
Power  
Socket  
Color temp.  
Lumen output  
Dimmability

Megaman MM3596  
6W  
GU10  
2800K  
300lm  
Dimmable (10-100%)

### LED - Philips Fortimo SLM Passive

LED incl.  
Driver incl.

Power  
Lm output  
Cooling  
Color Temp.  
CRI  
SDCM  
Lifetime

18W  
2000  
Passive (no fan)  
3000K / 4000K  
Ra80 / Ra90  
3  
50.000 Hrs (70%)



**Included**  
LED Drivers included on all LED-Luminaires

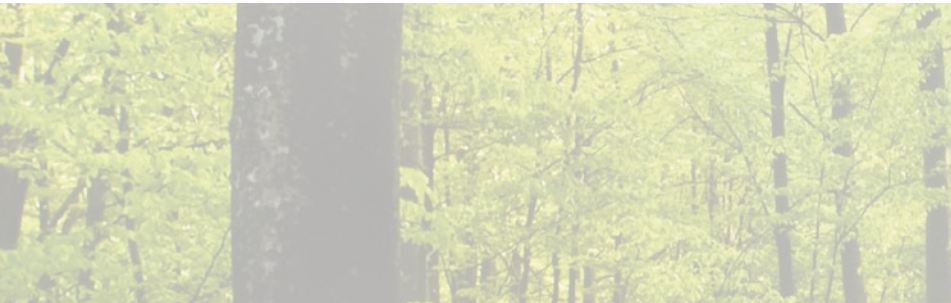

## Rondo

Small

|                     |                  |         |
|---------------------|------------------|---------|
| GU10 Socket         | 101.05.xx        | € 75.00 |
| GU10 (6W LED incl.) | 101.05.xx.MM3596 | € 95.00 |



## Rondo

Large

### 1x Philips Fortimo SLM 2000lm - 24° - Non dim.

|                                    |                      |          |
|------------------------------------|----------------------|----------|
| Ra80 - 3000K - 17.4W - 119-104lm/W | 101.2000.24.830.xx-C | € 234.00 |
| Ra80 - 4000K - 17.4W - 126-110lm/W | 101.2000.24.840.xx-C | € 234.00 |
| Ra90 - 3000K - 17.4W - 97-84lm/W   | 101.2000.24.930.xx-C | € 234.00 |
| Ra90 - 4000K - 17.4W - 104-91lm/W  | 101.2000.24.940.xx-C | € 234.00 |

### 1x Philips Fortimo SLM 2000lm - 36° - Non dim.

|                                    |                      |          |
|------------------------------------|----------------------|----------|
| Ra80 - 3000K - 17.4W - 119-104lm/W | 101.2000.36.830.xx-C | € 234.00 |
| Ra80 - 4000K - 17.4W - 126-110lm/W | 101.2000.36.840.xx-C | € 234.00 |
| Ra90 - 3000K - 17.4W - 97-84lm/W   | 101.2000.36.930.xx-C | € 234.00 |
| Ra90 - 4000K - 17.4W - 104-91lm/W  | 101.2000.36.940.xx-C | € 234.00 |

### 1x Philips Fortimo SLM 2000lm - 24° - Touch DIM & DALI

|                                    |                      |          |
|------------------------------------|----------------------|----------|
| Ra80 - 3000K - 17.4W - 119-104lm/W | 101.2000.24.830.xx-D | € 277.00 |
| Ra80 - 4000K - 17.4W - 126-110lm/W | 101.2000.24.840.xx-D | € 277.00 |
| Ra90 - 3000K - 17.4W - 97-84lm/W   | 101.2000.24.930.xx-D | € 277.00 |
| Ra90 - 4000K - 17.4W - 104-91lm/W  | 101.2000.24.940.xx-D | € 277.00 |

### 1x Philips Fortimo SLM 2000lm - 36° - Touch DIM & DALI

|                                    |                      |          |
|------------------------------------|----------------------|----------|
| Ra80 - 3000K - 17.4W - 119-104lm/W | 101.2000.36.830.xx-D | € 277.00 |
| Ra80 - 4000K - 17.4W - 126-110lm/W | 101.2000.36.840.xx-D | € 277.00 |
| Ra90 - 3000K - 17.4W - 97-84lm/W   | 101.2000.36.930.xx-D | € 277.00 |
| Ra90 - 4000K - 17.4W - 104-91lm/W  | 101.2000.36.940.xx-D | € 277.00 |

### LED vs. system efficacy

Ra00 - 0000K - 00.0W - 000-000lm/W

LED efficacy — System efficacy

Available colors: 0000.00.0000.00.xx

01: Matt White Texture  
Black, grey or other RAL colors on request!!

# Titan

## Semi Recessed

Type Surface mounted  
 Material Aluminium  
 Lamp Orientation Orientable

### LED - Bridgelux Vero 10

LED incl.  
 Driver to be ordered separately (option)  
 Power 9.2W / 350mA  
 Color temp. / Lm output  
 2700K: 865lm  
 3000K: 915lm  
 CRI Ra90  
 SDCM 3 (2 on request)  
 Lifetime 50.000 Hrs (70%)

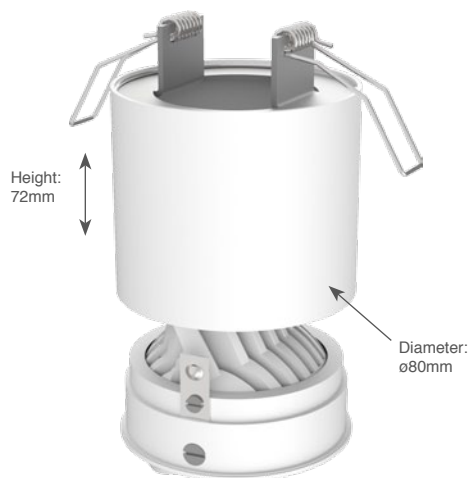

### Options

|                |           |         |
|----------------|-----------|---------|
| Driver non-dim | 490.24.20 | € 26.60 |
| Driver 1-10V   | 490.25.20 | € 43.40 |
| Driver DALI    | 490.26.20 | € 52.10 |

### On Request

LEDs with SDCM 2 (see p.160)  
 LEDs with 4000K (see p.160)  
 CRI up to Ra97 (see p.160)

Other RAL colors

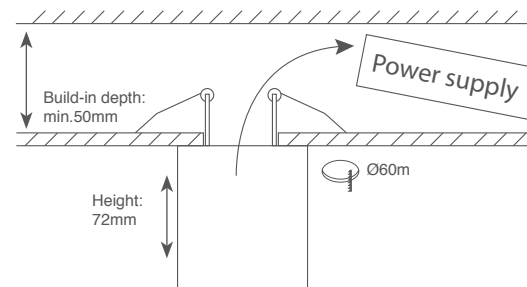





**Titan Semi-Recessed**  
Cone

|  |                    |         |
|--|--------------------|---------|
| <b>Bridgelux LED (350mA) + 28° Reflector</b> |                    |         |
| 2700K  | 1200.90.2700.28.01 | € 97.00 |
| 3000K  | 1200.90.3000.28.01 | € 97.00 |

|  |                    |         |
|--|--------------------|---------|
| <b>Bridgelux LED (350mA) + 40° Reflector</b> |                    |         |
| 2700K  | 1200.90.2700.40.01 | € 97.00 |
| 3000K  | 1200.90.3000.40.01 | € 97.00 |



**Titan Semi-Recessed**  
Organic

|  |                    |         |
|--|--------------------|---------|
| <b>Bridgelux LED (350mA) + 28° Reflector</b> |                    |         |
| 2700K  | 1201.90.2700.28.01 | € 97.00 |
| 3000K  | 1201.90.3000.28.01 | € 97.00 |

|  |                    |         |
|--|--------------------|---------|
| <b>Bridgelux LED (350mA) + 40° Reflector</b> |                    |         |
| 2700K  | 1201.90.2700.40.01 | € 97.00 |
| 3000K  | 1201.90.3000.40.01 | € 97.00 |



**Titan Semi-Recessed**  
Anti-glare

|  |                    |          |
|--|--------------------|----------|
| <b>Bridgelux LED (350mA) + 28° Reflector</b> |                    |          |
| 2700K  | 1202.90.2700.28.01 | € 105.00 |
| 3000K  | 1202.90.3000.28.01 | € 105.00 |

|  |                    |          |
|--|--------------------|----------|
| <b>Bridgelux LED (350mA) + 40° Reflector</b> |                    |          |
| 2700K  | 1202.90.2700.40.01 | € 105.00 |
| 3000K  | 1202.90.3000.40.01 | € 105.00 |

Titan has 3 variants: Cone  
Organic  
Anti-glare   
More info: p.159

Available colors: 0000.00.0000.00.xx  
01: Matt White Texture   
Black, grey or other RAL colors on request!!



# Titan

## Surface Mounted

Type Surface mounted  
Material Aluminium  
Lamp Orientation Orientable

### LED - Bridgelux Vero 10

LED incl.  
Driver non dim. incl.  
Luminaire with dimmable driver coming soon  
Power 9.2W / 350mA  
Color temp. / Lm output  
2700K: 865lm  
3000K: 915lm  
Ra90  
CRI  
SDCM 3 (2 on request)  
Lifetime 50.000 Hrs (70%)



### On Request

LEDs with SDCM 2 (see p.160)  
LEDs with 4000K (see p.160)  
CRI up to Ra97 (see p.160)

Other RAL colors



**Titan Surface Mounted**  
Cone

**Bridgelux LED (350mA) + 28° Reflector**  
2700K non dim. 1204.90.2700.28.01 € 208.00  
3000K non dim. 1204.90.3000.28.01 € 208.00

**Bridgelux LED (350mA) + 40° Reflector**  
2700K non dim. 1204.90.2700.40.01 € 208.00  
3000K non dim. 1204.90.3000.40.01 € 208.00



**Titan Surface Mounted**  
Organic

**Bridgelux LED (350mA) + 28° Reflector**  
2700K non dim. 1205.90.2700.28.01 € 208.00  
3000K non dim. 1205.90.3000.28.01 € 208.00

**Bridgelux LED (350mA) + 40° Reflector**  
2700K non dim. 1205.90.2700.40.01 € 208.00  
3000K non dim. 1205.90.3000.40.01 € 208.00



**Titan Surface Mounted**  
Anti-glare

**Bridgelux LED (350mA) + 28° Reflector**  
2700K non dim. 1206.90.2700.28.01 € 217.00  
3000K non dim. 1206.90.3000.28.01 € 217.00

**Bridgelux LED (350mA) + 40° Reflector**  
2700K non dim. 1206.90.2700.40.01 € 217.00  
3000K non dim. 1206.90.3000.40.01 € 217.00

Titan has 3 variants: Cone  
Organic  
Anti-glare  
More info: p.159



Available colors: 0000.00.0000.00.xx  
01: Matt White Texture color  
Black, grey or other RAL colors on request!!

# Moody

Type Surface Mounted / 3-Phase rail  
Material Aluminium  
Lamp Orientation Orientable

## LED - Philips Fortimo SLM Active

LED incl.  
Driver incl.  
Power 18W / 26W  
Lm output 2000 / 3000  
Cooling 2000lm: Passive (no fan)  
3000lm: Active (fan)  
Color Temp. 3000K / 4000K  
CRI Ra80 / Ra90  
SDCM 3  
Lifetime 50.000 Hrs (70%)



## Included

LED Drivers included on all LED-Luminaires



### Moody 3-Phase

#### Philips Fortimo SLM 2000lm (passive cooling) - Non dim.

|                                    |                      |          |
|------------------------------------|----------------------|----------|
| Ra80 - 3000K - 17.4W - 119-104lm/W | 374.2000.AA.830.01-C | € 230.00 |
| Ra80 - 4000K - 17.4W - 126-110lm/W | 374.2000.AA.840.01-C | € 230.00 |
| Ra90 - 3000K - 17.4W - 97-84lm/W   | 374.2000.AA.930.01-C | € 230.00 |
| Ra90 - 4000K - 17.4W - 104-91lm/W  | 374.2000.AA.940.01-C | € 230.00 |

#### Philips Fortimo SLM 3000lm (active cooling) - Non dim.

|                                    |                      |          |
|------------------------------------|----------------------|----------|
| Ra80 - 3000K - 25.9W - 118-103lm/W | 374.3000.AA.830.01-C | € 260.00 |
| Ra80 - 4000K - 25.9W - 126-110lm/W | 374.3000.AA.840.01-C | € 260.00 |
| Ra90 - 3000K - 25.9W - 95-83lm/W   | 374.3000.AA.930.01-C | € 260.00 |
| Ra90 - 4000K - 25.9W - 103-90lm/W  | 374.3000.AA.940.01-C | € 260.00 |



### Moody Base

#### Philips Fortimo SLM 2000lm (passive cooling) - Non dim.

|                                    |                      |          |
|------------------------------------|----------------------|----------|
| Ra80 - 3000K - 17.4W - 119-104lm/W | 373.2000.AA.830.01-C | € 230.00 |
| Ra80 - 4000K - 17.4W - 126-110lm/W | 373.2000.AA.840.01-C | € 230.00 |
| Ra90 - 3000K - 17.4W - 97-84lm/W   | 373.2000.AA.930.01-C | € 230.00 |
| Ra90 - 4000K - 17.4W - 104-91lm/W  | 373.2000.AA.940.01-C | € 230.00 |

#### Philips Fortimo SLM 3000lm (active cooling) - Non dim.

|                                    |                      |          |
|------------------------------------|----------------------|----------|
| Ra80 - 3000K - 25.9W - 118-103lm/W | 373.3000.AA.830.01-C | € 260.00 |
| Ra80 - 4000K - 25.9W - 126-110lm/W | 373.3000.AA.840.01-C | € 260.00 |
| Ra90 - 3000K - 25.9W - 95-83lm/W   | 373.3000.AA.930.01-C | € 260.00 |
| Ra90 - 4000K - 25.9W - 103-90lm/W  | 373.3000.AA.940.01-C | € 260.00 |

#### LED vs. system efficacy

Ra00 - 0000K - 00.0W - 000-000lm/W  
 LED efficacy  $\square$  System efficacy  $\square$

#### Available beam angles: 000.0000.AA.000.00-0

24: 24° Reflector  $\square$  Beam angle  
 36: 36° Reflector  $\square$

#### Available colors: 000.0000.AA.000.00.xx

01: Matt White Texture  $\square$  color  
 Other RAL colors on request!!





## Collector Box

### Single

|               |             |          |
|---------------|-------------|----------|
| 1x QR-111     | 491.07.xx   | € 140.00 |
| 1x CDM-TC 30° | 491.13.xx-S | € 243.00 |
| 1x CDM-R-111  | 491.14.xx   | € 243.00 |

### 1x Philips Fortimo SLM 2000lm - 24° - Non dim.

|                                    |                      |          |
|------------------------------------|----------------------|----------|
| Ra80 - 3000K - 17.4W - 119-104lm/W | 491.2000.24.830.xx-C | € 218.00 |
| Ra80 - 4000K - 17.4W - 126-110lm/W | 491.2000.24.840.xx-C | € 218.00 |
| Ra90 - 3000K - 17.4W - 97-84lm/W   | 491.2000.24.930.xx-C | € 218.00 |
| Ra90 - 4000K - 17.4W - 104-91lm/W  | 491.2000.24.940.xx-C | € 218.00 |

### 1x Philips Fortimo SLM 2000lm - 36° - Non dim.

|                                    |                      |          |
|------------------------------------|----------------------|----------|
| Ra80 - 3000K - 17.4W - 119-104lm/W | 491.2000.36.830.xx-C | € 218.00 |
| Ra80 - 4000K - 17.4W - 126-110lm/W | 491.2000.36.840.xx-C | € 218.00 |
| Ra90 - 3000K - 17.4W - 97-84lm/W   | 491.2000.36.930.xx-C | € 218.00 |
| Ra90 - 4000K - 17.4W - 104-91lm/W  | 491.2000.36.940.xx-C | € 218.00 |

### 1x Philips Fortimo SLM 2000lm - 24° - Touch DIM & DALI

|                                    |                      |          |
|------------------------------------|----------------------|----------|
| Ra80 - 3000K - 17.4W - 119-104lm/W | 491.2000.24.830.xx-D | € 263.00 |
| Ra80 - 4000K - 17.4W - 126-110lm/W | 491.2000.24.840.xx-D | € 263.00 |
| Ra90 - 3000K - 17.4W - 97-84lm/W   | 491.2000.24.930.xx-D | € 263.00 |
| Ra90 - 4000K - 17.4W - 104-91lm/W  | 491.2000.24.940.xx-D | € 263.00 |

### 1x Philips Fortimo SLM 2000lm - 36° - Touch DIM & DALI

|                                    |                      |          |
|------------------------------------|----------------------|----------|
| Ra80 - 3000K - 17.4W - 119-104lm/W | 491.2000.36.830.xx-D | € 263.00 |
| Ra80 - 4000K - 17.4W - 126-110lm/W | 491.2000.36.840.xx-D | € 263.00 |
| Ra90 - 3000K - 17.4W - 97-84lm/W   | 491.2000.36.930.xx-D | € 263.00 |
| Ra90 - 4000K - 17.4W - 104-91lm/W  | 491.2000.36.940.xx-D | € 263.00 |



## Collector Box

### Double

|               |             |          |
|---------------|-------------|----------|
| 2x QR-111     | 492.07.xx   | € 210.00 |
| 2x CDM-TC 30° | 492.13.xx-S | € 431.00 |
| 2x CDM-R-111  | 492.14.xx   | € 431.00 |

### 2x Philips Fortimo SLM 2000lm - 24° - Non dim.

|                                      |                      |          |
|--------------------------------------|----------------------|----------|
| Ra80 - 3000K - 2x17.4W - 119-104lm/W | 492.2000.24.830.xx-C | € 412.00 |
| Ra80 - 4000K - 2x17.4W - 126-110lm/W | 492.2000.24.840.xx-C | € 412.00 |
| Ra90 - 3000K - 2x17.4W - 97-84lm/W   | 492.2000.24.930.xx-C | € 412.00 |
| Ra90 - 4000K - 2x17.4W - 104-91lm/W  | 492.2000.24.940.xx-C | € 412.00 |

### 2x Philips Fortimo SLM 2000lm - 36° - Non dim.

|                                      |                      |          |
|--------------------------------------|----------------------|----------|
| Ra80 - 3000K - 2x17.4W - 119-104lm/W | 492.2000.36.830.xx-C | € 412.00 |
| Ra80 - 4000K - 2x17.4W - 126-110lm/W | 492.2000.36.840.xx-C | € 412.00 |
| Ra90 - 3000K - 2x17.4W - 97-84lm/W   | 492.2000.36.930.xx-C | € 412.00 |
| Ra90 - 4000K - 2x17.4W - 104-91lm/W  | 492.2000.36.940.xx-C | € 412.00 |

### 2x Philips Fortimo SLM 2000lm - 24° - Touch DIM & DALI

|                                      |                      |          |
|--------------------------------------|----------------------|----------|
| Ra80 - 3000K - 2x17.4W - 119-104lm/W | 492.2000.24.830.xx-D | € 497.00 |
| Ra80 - 4000K - 2x17.4W - 126-110lm/W | 492.2000.24.840.xx-D | € 497.00 |
| Ra90 - 3000K - 2x17.4W - 97-84lm/W   | 492.2000.24.930.xx-D | € 497.00 |
| Ra90 - 4000K - 2x17.4W - 104-91lm/W  | 492.2000.24.940.xx-D | € 497.00 |

### 2x Philips Fortimo SLM 2000lm - 36° - Touch DIM & DALI

|                                      |                      |          |
|--------------------------------------|----------------------|----------|
| Ra80 - 3000K - 2x17.4W - 119-104lm/W | 492.2000.36.830.xx-D | € 497.00 |
| Ra80 - 4000K - 2x17.4W - 126-110lm/W | 492.2000.36.840.xx-D | € 497.00 |
| Ra90 - 3000K - 2x17.4W - 97-84lm/W   | 492.2000.36.930.xx-D | € 497.00 |
| Ra90 - 4000K - 2x17.4W - 104-91lm/W  | 492.2000.36.940.xx-D | € 497.00 |

#### LED vs. system efficacy

Ra00 - 0000K - 00.0W - 000-000lm/W

LED efficacy  $\lrcorner$  System efficacy



## Collector Box

### Triple

|               |             |          |
|---------------|-------------|----------|
| 3x QR-111     | 493.07.xx   | € 290.00 |
| 3x CDM-TC 30° | 493.13.xx-S | € 613.00 |
| 3x CDM-R-111  | 493.14.xx   | € 613.00 |

### 3x Philips Fortimo SLM 2000lm - 24° - Non dim.

|                                      |                      |          |
|--------------------------------------|----------------------|----------|
| Ra80 - 3000K - 3x17.4W - 119-104lm/W | 493.2000.24.830.xx-C | € 556.00 |
| Ra80 - 4000K - 3x17.4W - 126-110lm/W | 493.2000.24.840.xx-C | € 556.00 |
| Ra90 - 3000K - 3x17.4W - 97-84lm/W   | 493.2000.24.930.xx-C | € 556.00 |
| Ra90 - 4000K - 3x17.4W - 104-91lm/W  | 493.2000.24.940.xx-C | € 556.00 |

### 3x Philips Fortimo SLM 2000lm - 36° - Non dim.

|                                      |                      |          |
|--------------------------------------|----------------------|----------|
| Ra80 - 3000K - 3x17.4W - 119-104lm/W | 493.2000.36.830.xx-C | € 556.00 |
| Ra80 - 4000K - 3x17.4W - 126-110lm/W | 493.2000.36.840.xx-C | € 556.00 |
| Ra90 - 3000K - 3x17.4W - 97-84lm/W   | 493.2000.36.930.xx-C | € 556.00 |
| Ra90 - 4000K - 3x17.4W - 104-91lm/W  | 493.2000.36.940.xx-C | € 556.00 |

### 3x Philips Fortimo SLM 2000lm - 24° - Touch DIM & DALI

|                                      |                      |          |
|--------------------------------------|----------------------|----------|
| Ra80 - 3000K - 3x17.4W - 119-104lm/W | 493.2000.24.830.xx-D | € 676.00 |
| Ra80 - 4000K - 3x17.4W - 126-110lm/W | 493.2000.24.840.xx-D | € 676.00 |
| Ra90 - 3000K - 3x17.4W - 97-84lm/W   | 493.2000.24.930.xx-D | € 676.00 |
| Ra90 - 4000K - 3x17.4W - 104-91lm/W  | 493.2000.24.940.xx-D | € 676.00 |

### 3x Philips Fortimo SLM 2000lm - 36° - Touch DIM & DALI

|                                      |                      |          |
|--------------------------------------|----------------------|----------|
| Ra80 - 3000K - 3x17.4W - 119-104lm/W | 493.2000.36.830.xx-D | € 676.00 |
| Ra80 - 4000K - 3x17.4W - 126-110lm/W | 493.2000.36.840.xx-D | € 676.00 |
| Ra90 - 3000K - 3x17.4W - 97-84lm/W   | 493.2000.36.930.xx-D | € 676.00 |
| Ra90 - 4000K - 3x17.4W - 104-91lm/W  | 493.2000.36.940.xx-D | € 676.00 |

Available colors: 0000.0000.00.xx

01: Matt White Texture

05: Matt White Texture + Matt Black Texture

Black Matt Texture Paint on request



# Titan Box

Type Surface Mounted / Suspended  
 Material Aluminium + Steel  
 Lamp Orientation Orientable

## LED - Bridgelux Vero 10

2x LED incl.  
 Driver non dim. incl.  
 Luminaire with dimmable driver coming soon  
 Power (2x) 9.2W / 350mA  
 Color temp. / Lm output 2700K; (2x) 865lm  
 3000K; (2x) 915lm

CRI Ra90  
 SDCM 3 (2 on request)  
 Lifetime 50.000 Hrs (70%)

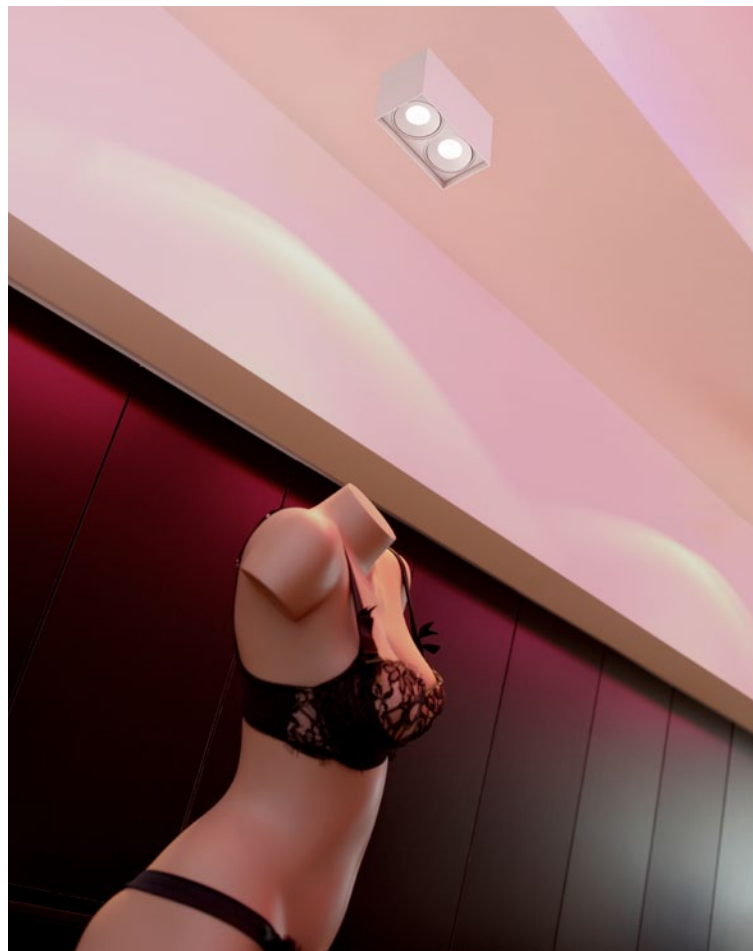
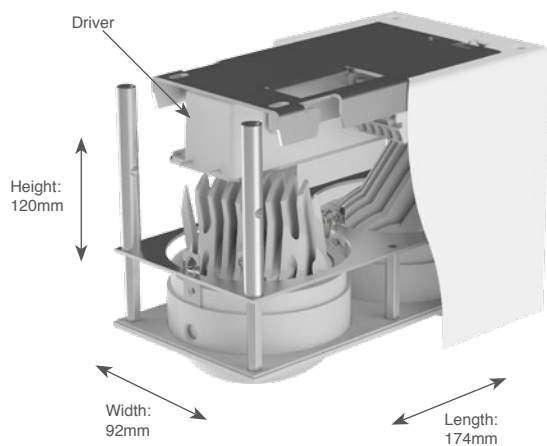

## Options

Suspension set 1407.00.01 € 40.00

## On Request

LEDs with SDCM 2 (see p.160)  
 LEDs with 4000K (see p.160)  
 CRI up to Ra97 (see p.160)

Other RAL colors

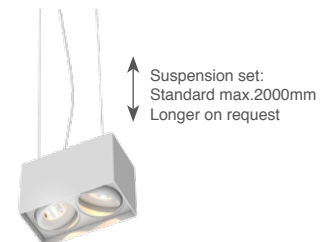



**Titan Box**  
Cone

**Bridgelux LED (350mA) + 28° Reflector**  
 2700K non dim. 1406.90.2700.28.01 € 350.00  
 3000K non dim. 1406.90.3000.28.01 € 350.00

**Bridgelux LED (350mA) + 40° Reflector**  
 2700K non dim. 1406.90.2700.40.01 € 350.00  
 3000K non dim. 1406.90.3000.40.01 € 350.00

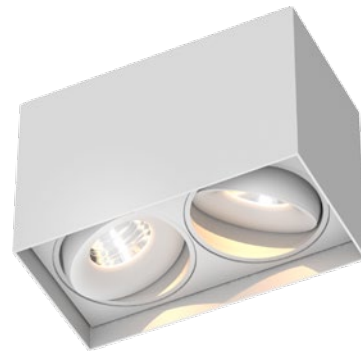

**Titan Box**  
Organic

**Bridgelux LED (350mA) + 28° Reflector**  
 2700K non dim. 1407.90.2700.28.01 € 350.00  
 3000K non dim. 1407.90.3000.28.01 € 350.00

**Bridgelux LED (350mA) + 40° Reflector**  
 2700K non dim. 1407.90.2700.40.01 € 350.00  
 3000K non dim. 1407.90.3000.40.01 € 350.00

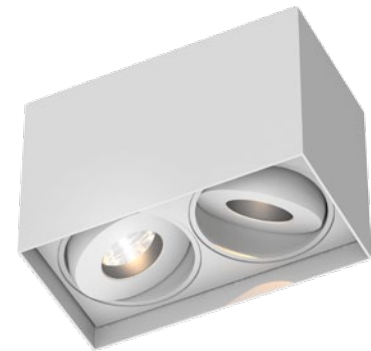

**Titan Box**  
Anti-glare

**Bridgelux LED (350mA) + 28° Reflector**  
 2700K non dim. 1408.90.2700.28.01 € 368.00  
 3000K non dim. 1408.90.3000.28.01 € 368.00

**Bridgelux LED (350mA) + 40° Reflector**  
 2700K non dim. 1408.90.2700.40.01 € 368.00  
 3000K non dim. 1408.90.3000.40.01 € 368.00

Titan has 3 variants: Cone  
 Organic  
 Anti-glare  
 More info: p.159



Available colors: 0000.00.0000.00.xx  
 01: Matt White Texture  
 Black, grey or other RAL colors on request!!





### Titan Suspended

Cone

**Bridgelux LED (350mA) + 28° Reflector**  
 2700K non dim. 1400.90.2700.28.01 € 480.00  
 3000K non dim. 1400.90.3000.28.01 € 480.00

**Bridgelux LED (350mA) + 40° Reflector**  
 2700K non dim. 1400.90.2700.40.01 € 480.00  
 3000K non dim. 1400.90.3000.40.01 € 480.00



### Titan Suspended

Organic

**Bridgelux LED (350mA) + 28° Reflector**  
 2700K non dim. 1401.90.2700.28.01 € 480.00  
 3000K non dim. 1401.90.3000.28.01 € 480.00

**Bridgelux LED (350mA) + 40° Reflector**  
 2700K non dim. 1401.90.2700.40.01 € 480.00  
 3000K non dim. 1401.90.3000.40.01 € 480.00





### Titan Suspended

Anti-glare

**Bridgelux LED (350mA) + 28° Reflector**  
 2700K non dim. 1402.90.2700.28.01 € 498.00  
 3000K non dim. 1402.90.3000.28.01 € 498.00

**Bridgelux LED (350mA) + 40° Reflector**  
 2700K non dim. 1402.90.2700.40.01 € 498.00  
 3000K non dim. 1402.90.3000.40.01 € 498.00

Titan has 3 variants: Cone  
 Organic  
 Anti-glare   
 More info: p.159

Available colors: 0000.00.0000.00.xx  
 01: Matt White Texture   
 Black, grey or other RAL colors on request!!





### Titan Suspended T2

Cone

**Bridgelux LED (350mA) + 28° Reflector**

2700K non dim. 1403.90.2700.28.01 € 480.00

3000K non dim. 1403.90.3000.28.01 € 480.00

**Bridgelux LED (350mA) + 40° Reflector**

2700K non dim. 1403.90.2700.40.01 € 480.00

3000K non dim. 1403.90.3000.40.01 € 480.00



### Titan Suspended T2

Organic

**Bridgelux LED (350mA) + 28° Reflector**

2700K non dim. 1404.90.2700.28.01 € 480.00

3000K non dim. 1404.90.3000.28.01 € 480.00

**Bridgelux LED (350mA) + 40° Reflector**

2700K non dim. 1404.90.2700.40.01 € 480.00

3000K non dim. 1404.90.3000.40.01 € 480.00



### Titan Suspended T2

Anti-glare

**Bridgelux LED (350mA) + 28° Reflector**

2700K non dim. 1405.90.2700.28.01 € 498.00

3000K non dim. 1405.90.3000.28.01 € 498.00

**Bridgelux LED (350mA) + 40° Reflector**

2700K non dim. 1405.90.2700.40.01 € 498.00

3000K non dim. 1405.90.3000.40.01 € 498.00

Titan has 3 variants: Cone

Organic

Anti-glare

More info: p.159



Available colors: 0000.00.0000.00.xx

01: Matt White Texture

Black, grey or other RAL colors on request!!





# Titan

## Arm 2-way

Type Wall Mounted  
Material Aluminium  
Lamp Orientation Orientable

### LED - Bridgelux Vero 10

2x LED incl.  
Driver non dim. incl.  
Luminaire with dimmable driver coming soon  
Power (2x) 9.2W / 350mA  
Color temp. / Lm output 2700K; (2x) 865lm  
3000K; (2x) 915lm

CRI Ra90  
SDCM 3 (2 on request)  
Lifetime 50.000 Hrs (70%)

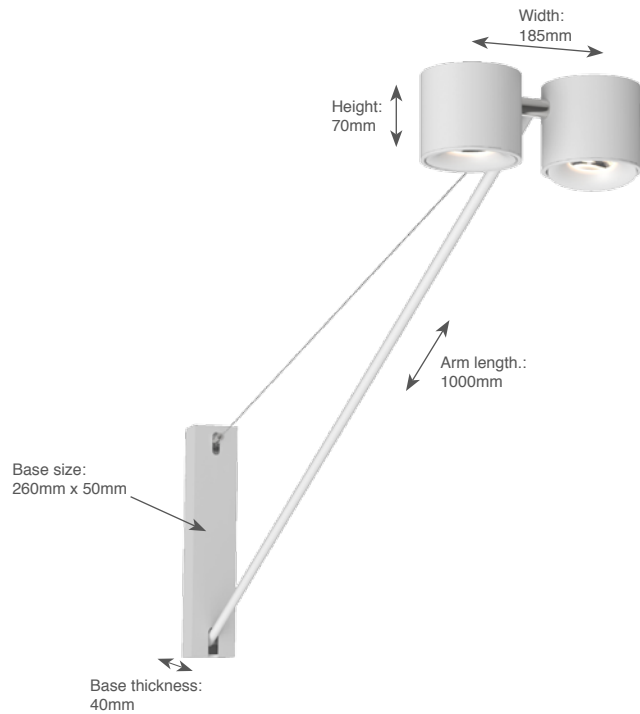

### On Request

LEDs with SDCM 2 (see p.160)  
LEDs with 4000K (see p.160)  
CRI up to Ra97 (see p.160)

Other RAL colors



### Titan Arm 2-way Cone

**Bridgelux LED (350mA) + 28° Reflector**  
 2700K non dim. 1306.90.2700.28.01 € 594.00  
 3000K non dim. 1306.90.3000.28.01 € 594.00

**Bridgelux LED (350mA) + 40° Reflector**  
 2700K non dim. 1306.90.2700.40.01 € 594.00  
 3000K non dim. 1306.90.3000.40.01 € 594.00



### Titan Arm 2-way Organic

**Bridgelux LED (350mA) + 28° Reflector**  
 2700K non dim. 1307.90.2700.28.01 € 594.00  
 3000K non dim. 1307.90.3000.28.01 € 594.00

**Bridgelux LED (350mA) + 40° Reflector**  
 2700K non dim. 1307.90.2700.40.01 € 594.00  
 3000K non dim. 1307.90.3000.40.01 € 594.00



### Titan Arm 2-way Anti-Glare

**Bridgelux LED (350mA) + 28° Reflector**  
 2700K non dim. 1308.90.2700.28.01 € 612.00  
 3000K non dim. 1308.90.3000.28.01 € 612.00

**Bridgelux LED (350mA) + 40° Reflector**  
 2700K non dim. 1308.90.2700.40.01 € 612.00  
 3000K non dim. 1308.90.3000.40.01 € 612.00

Titan has 3 variants: Cone  
 Organic  
 Anti-glare   
 More info: p.159

Available colors: 0000.00.0000.00.xx  
 01: Matt White Texture   
 Black, grey or other RAL colors on request!!

# Titan

## Arm 4-way

Type Wall Mounted  
 Material Aluminium  
 Lamp Orientation Orientable

### LED - Bridgelux Vero 10

4x LED incl.  
 Driver non dim. incl.  
 Luminaire with dimmable driver coming soon  
 Power (4x) 9.2W / 350mA  
 Color temp. / Lm output  
 2700K: (4x) 865lm  
 3000K: (4x) 915lm

CRI Ra90  
 SDCM 3 (2 on request)  
 Lifetime 50.000 Hrs (70%)

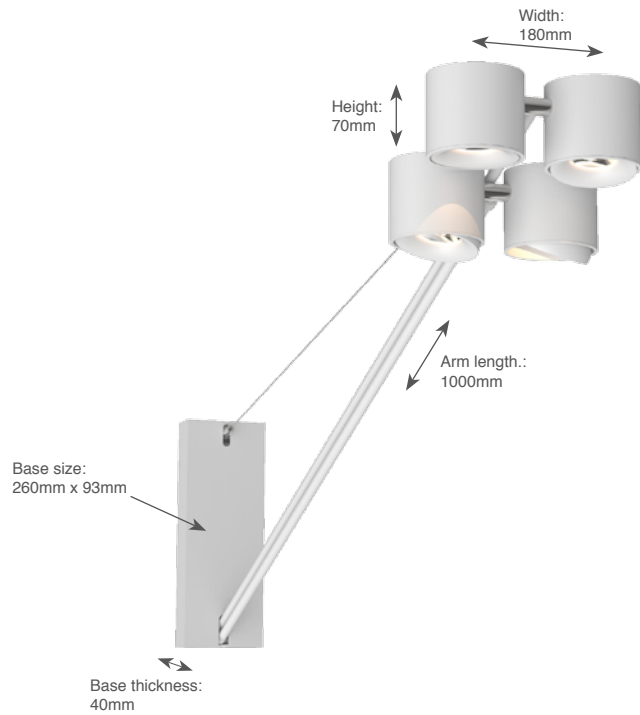

### On Request

LEDs with SDCM 2 (see p.160)  
 LEDs with 4000K (see p.160)  
 CRI up to Ra97 (see p.160)

Other RAL colors

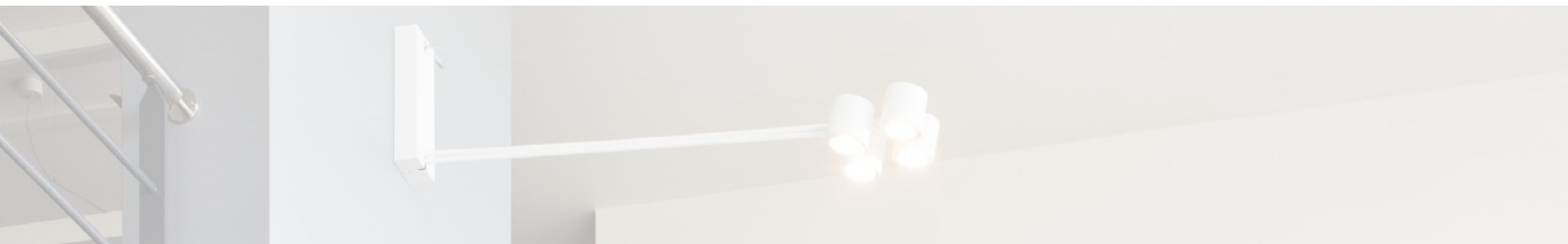

### Titan Arm 4-way Cone

**Bridgelux LED (350mA) + 28° Reflector**  
 2700K non dim. 1309.90.2700.28.01 € 990.00  
 3000K non dim. 1309.90.3000.28.01 € 990.00

**Bridgelux LED (350mA) + 40° Reflector**  
 2700K non dim. 1309.90.2700.40.01 € 990.00  
 3000K non dim. 1309.90.3000.40.01 € 990.00



### Titan Arm 4-way Organic

**Bridgelux LED (350mA) + 28° Reflector**  
 2700K non dim. 1310.90.2700.28.01 € 990.00  
 3000K non dim. 1310.90.3000.28.01 € 990.00

**Bridgelux LED (350mA) + 40° Reflector**  
 2700K non dim. 1310.90.2700.40.01 € 990.00  
 3000K non dim. 1310.90.3000.40.01 € 990.00



### Titan Arm 4-way Anti-glare

**Bridgelux LED (350mA) + 28° Reflector**  
 2700K non dim. 1311.90.2700.28.01 € 1030.00  
 3000K non dim. 1311.90.3000.28.01 € 1030.00

**Bridgelux LED (350mA) + 40° Reflector**  
 2700K non dim. 1311.90.2700.40.01 € 1030.00  
 3000K non dim. 1311.90.3000.40.01 € 1030.00

Titan has 3 variants: Cone  
 Organic  
 Anti-glare  
 More info: p.159



Available colors: 0000.00.0000.00.xx  
 01: Matt White Texture  
 Black, grey or other RAL colors on request!!



# Lounge

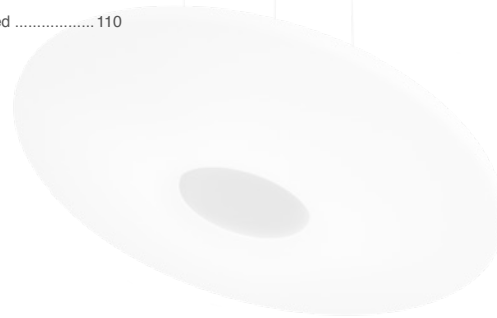

## Suspended

|                     |     |
|---------------------|-----|
| <b>Tunnel</b>       |     |
| Tunnel 600.....     | 102 |
| Tunnel 900.....     | 102 |
| Tunnel 1200.....    | 102 |
| Tunnel Double ..... | 104 |
| Tunnel Triple.....  | 104 |

|                    |     |
|--------------------|-----|
| <b>Full Moon</b>   |     |
| Full moon 40.....  | 106 |
| Full moon 60.....  | 106 |
| Full moon 90.....  | 106 |
| Full moon 120..... | 106 |

|                   |     |
|-------------------|-----|
| <b>Dome</b>       |     |
| Dome.....         | 108 |
| Dome RGB .....    | 108 |
| Dome Fortimo..... | 108 |

|                        |     |
|------------------------|-----|
| <b>Globe / Eclipse</b> |     |
| Globe Suspended.....   | 114 |
| Eclipse Suspended..... | 114 |

|                              |     |
|------------------------------|-----|
| <b>Palladium / Palladino</b> |     |
| Palladino.....               | 116 |
| Palladium.....               | 116 |
| Palladium T2.....            | 116 |

## Surface Mounted

|                    |     |
|--------------------|-----|
| <b>Full Moon</b>   |     |
| Full moon 40.....  | 106 |
| Full moon 60.....  | 106 |
| Full moon 90.....  | 106 |
| Full moon 110..... | 106 |

|                           |     |
|---------------------------|-----|
| <b>Tube</b>               |     |
| Tube Surface Mounted..... | 110 |

|                              |     |
|------------------------------|-----|
| <b>Globe / Eclipse</b>       |     |
| Globe Surface Mounted.....   | 112 |
| Eclipse Surface Mounted..... | 112 |

|                              |     |
|------------------------------|-----|
| <b>Palladium / Palladino</b> |     |
| Palladino.....               | 116 |
| Palladium.....               | 116 |
| Palladium T2.....            | 116 |

## Recessed

|                     |     |
|---------------------|-----|
| <b>Tube</b>         |     |
| Tube Recessed ..... | 110 |



# Tunnel Vertical

Type Suspended  
Material Aluminium + Polycarbonate  
Suspension set incl.

T5  
Ballast Incl.  
T5 Lightsources not incl.  
Power:

Tunnel Vertical 600: 2x 14/24W  
Tunnel Vertical 900: 2x 21/39W  
Tunnel Vertical 1200: 2x 28/54W

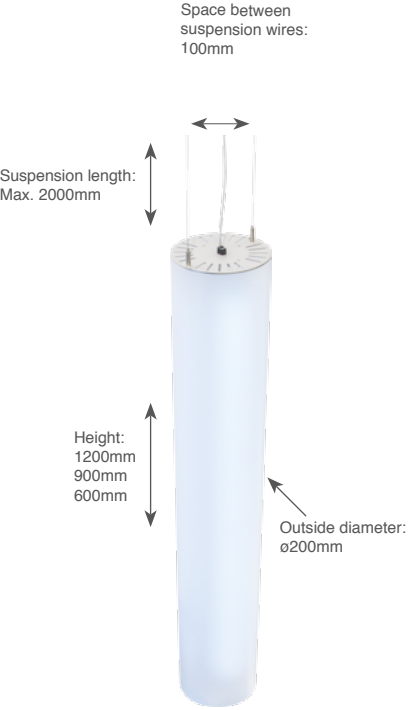

**On Request**  
Custom suspension length (longer than 2000mm)

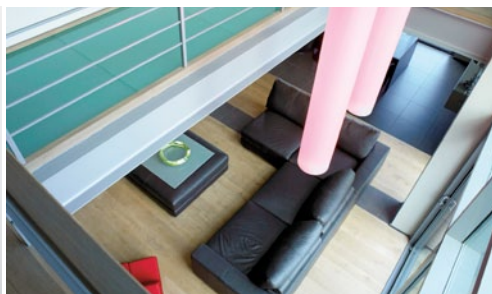
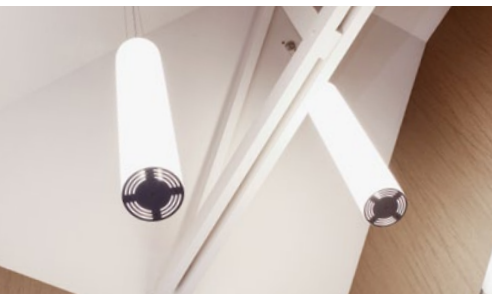

**Tunnel Vertical**  
600

|                         |              |          |  |
|-------------------------|--------------|----------|--|
| <b>T5</b>               |              |          |  |
| 2x 14/24W non dim       | 319.24.14/24 | € 463.00 |  |
| 2x 24W 1-10V dim        | 319.25.24    | € 541.00 |  |
| 2x 24W Touch DIM & DALI | 319.26.24    | € 560.70 |  |



**Tunnel Vertical**  
900

|                         |              |          |  |
|-------------------------|--------------|----------|--|
| <b>T5</b>               |              |          |  |
| 2x 21/39W non dim       | 319.24.21/39 | € 595.00 |  |
| 2x 39W 1-10V dim        | 319.25.39    | € 668.00 |  |
| 2x 39W Touch DIM & DALI | 319.26.39    | € 685.00 |  |



**Tunnel Vertical**  
1200

|                         |              |          |  |
|-------------------------|--------------|----------|--|
| <b>T5</b>               |              |          |  |
| 2x 28/54W non dim       | 319.24.28/54 | € 641.00 |  |
| 2x 54W 1-10V dim        | 319.25.54    | € 732.00 |  |
| 2x 54W Touch DIM & DALI | 319.26.54    | € 748.00 |  |

# Tunnel Vertical

## Double / Triple

Type Suspended  
Material Aluminium + Polycarbonate  
Suspension set incl.

**T5**  
Power (Double) (4x) 28/54W  
Power (Triple) (6x) 28/54W

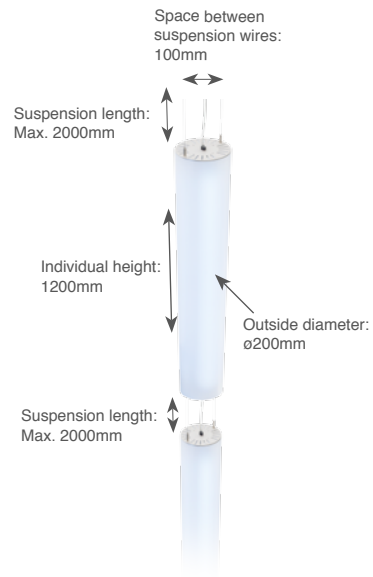



### Tunnel Vertical Double

|                         |                |           |  |
|-------------------------|----------------|-----------|--|
| <b>T5</b>               |                |           |  |
| 4x 28/54W non dim       | 319.24.28/54-2 | € 1216.00 |  |
| 4x 54W 1-10V dim        | 319.25.54-2    | € 1440.00 |  |
| 4x 54W Touch DIM & DALI | 319.26.54-2    | € 1470.00 |  |



### Tunnel Vertical Triple

|                         |                |           |  |
|-------------------------|----------------|-----------|--|
| <b>T5</b>               |                |           |  |
| 6x 28/54W non dim       | 319.24.28/54-3 | € 1867.00 |  |
| 6x 54W 1-10V dim        | 319.25.54-3    | € 2484.00 |  |
| 6x 54W Touch DIM & DALI | 319.26.54-3    | € 2532.00 |  |

# Full Moon

Type Surface Mounted / Suspended  
 Material Aluminium + PC  
 Suspension set not incl.

## Philips Fortimo LED-Line

LED incl.  
 LED Driver(s) incl.  
 Power 48.6W / 73W / 97.6W / 130W  
 Lm output 6600 / 9900 / 13200 / 17600  
 Color temp 3000K (4000K on request)  
 CRI Ra80  
 SDCM 3.5  
 Lifetime 50.000 Hrs (70%)

## LEDstrip

LEDstrip + Remote incl.  
 LEDstrip driver incl.

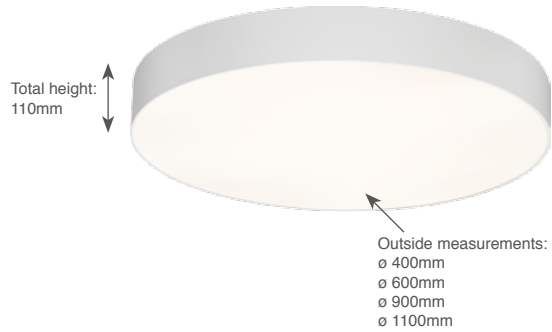

## Options

| Suspension set (max. 2000mm)         |           |         |
|--------------------------------------|-----------|---------|
| Suspension set 3x0.75mm <sup>2</sup> | 100.24.03 | € 49.00 |
| Suspension set 5x0.75mm <sup>2</sup> | 100.24.05 | € 70.00 |
| Suspension set 7x0.75mm <sup>2</sup> | 100.24.07 | € 97.00 |

## Included

LED Modules & LED Drivers



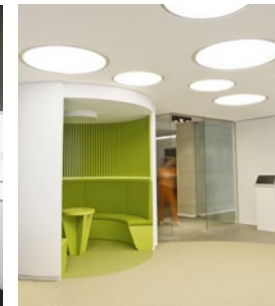

### Full Moon 600

|                                    |                    |          |
|------------------------------------|--------------------|----------|
| <b>LED-Line 48.6W 6600lm 3000K</b> |                    |          |
| Non dimmable                       | 160.24.6600.830.xx | € 559.00 |
| 1-10V dimmable                     | 160.25.6600.830.xx | € 629.00 |
| Touch DIM & DALI                   | 160.26.6600.830.xx | € 635.00 |

|                  |                  |          |
|------------------|------------------|----------|
| <b>LEDStrip</b>  |                  |          |
| RGB incl. remote | 160.30.55.RGB.xx | € 602.00 |



### Full Moon 400

|              |              |          |
|--------------|--------------|----------|
| <b>T5-c</b>  |              |          |
| Non dimmable | 100.24.22-01 | € 336.00 |

|                  |                    |          |
|------------------|--------------------|----------|
| <b>LED</b>       |                    |          |
| Non dimmable     | 100.24.1250.830.01 | € 495.00 |
| Touch DIM & DALI | 100.26.1250.830.01 | € 565.00 |



### Full Moon 900

|                               |                    |          |
|-------------------------------|--------------------|----------|
| <b>LED 48.6W 6600lm 3000K</b> |                    |          |
| Non dimmable                  | 190.24.6600.830.xx | € 788.00 |
| 1-10V dimmable                | 190.25.6600.830.xx | € 858.00 |
| Touch DIM & DALI              | 190.26.6600.830.xx | € 865.00 |

|                                  |                    |           |
|----------------------------------|--------------------|-----------|
| <b>LED-Line 73W 9900lm 3000K</b> |                    |           |
| Non dimmable                     | 190.24.9900.830.xx | € 925.00  |
| 1-10V dimmable                   | 190.25.9900.830.xx | € 1063.00 |
| Touch DIM & DALI                 | 190.26.9900.830.xx | € 1075.00 |

|                                     |                     |           |
|-------------------------------------|---------------------|-----------|
| <b>LED-Line 97.2W 13200lm 3000K</b> |                     |           |
| Non dimmable                        | 190.24.13200.830.xx | € 993.00  |
| 1-10V dimmable                      | 190.25.13200.830.xx | € 1133.00 |
| Touch DIM & DALI                    | 190.26.13200.830.xx | € 1145.00 |

|                  |                  |          |
|------------------|------------------|----------|
| <b>LEDStrip</b>  |                  |          |
| RGB incl. remote | 190.30.55.RGB.xx | € 958.00 |



### Full Moon 1100

|                                   |                      |           |
|-----------------------------------|----------------------|-----------|
| <b>LED-Line 81W 11000lm 3000K</b> |                      |           |
| Non dimmable                      | 1100.24.11000.830.xx | € 969.00  |
| 1-10V dimmable                    | 1100.25.11000.830.xx | € 1080.00 |
| Touch DIM & DALI                  | 1100.26.11000.830.xx | € 1089.00 |

|                                     |                      |           |
|-------------------------------------|----------------------|-----------|
| <b>LED-Line 97.2W 13200lm 3000K</b> |                      |           |
| Non dimmable                        | 1100.24.13200.830.xx | € 1062.00 |
| 1-10V dimmable                      | 1100.25.13200.830.xx | € 1229.00 |
| Touch DIM & DALI                    | 1100.26.13200.830.xx | € 1241.00 |

|                                    |                      |           |
|------------------------------------|----------------------|-----------|
| <b>LED-Line 130W 17600lm 3000K</b> |                      |           |
| Non dimmable                       | 1100.24.17600.830.xx | € 1252.00 |
| 1-10V dimmable                     | 1100.25.17600.830.xx | € 1483.00 |
| Touch DIM & DALI                   | 1100.26.17600.830.xx | € 1504.00 |

|                  |                   |           |
|------------------|-------------------|-----------|
| <b>LEDStrip</b>  |                   |           |
| RGB incl. remote | 1100.30.55.RGB.xx | € 1231.00 |

Available colors: 0000.0000.00.xx  
**01:** Matt White Texture  
**18:** Matt Grey Texture  
 Matt Black Texture on request!!



# Dome

Type                   Suspended  
 Material               Aluminium  
 Suspension set incl.

**E27**  
 Lightsource not included

**GU10**  
 Lightsource not incl.  
 Power                   max.50W  
 Socket                   GU10

**GU10 + LEDstrip**  
 GU10 lightsource not incl.  
 LEDstrip + remote incl.  
 LEDstrip driver incl.



**Philips Fortimo SLM (3x)**  
 LED incl.  
 Driver incl.  
 Power                   18W  
 Lm output               2000  
 Cooling                  Passive (no fan)  
 Color Temp.           3000K / 4000K  
 CRI                       Ra80 / Ra90  
 SDCM                   3  
 Lifetime                 50.000 Hrs (70%)



Suspension cables + power supply max. 2100mm



## On Request

LEDs with 4000K  
 Other RAL colors

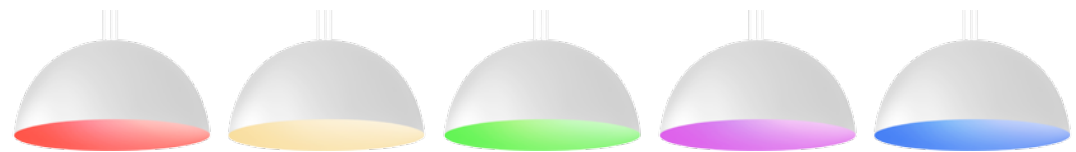

GU10 + RGB

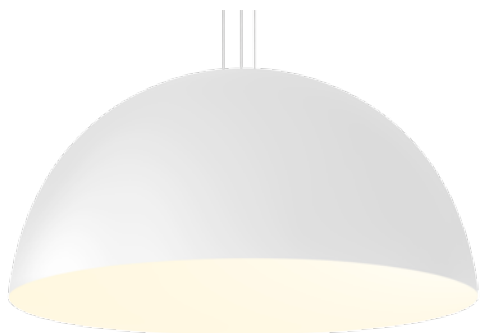

**Dome**  
E27/GU10

|                |           |          |
|----------------|-----------|----------|
| <b>E27</b>     |           |          |
| 1x E27 Socket  | 105.24.01 | € 625.00 |
| <b>GU10</b>    |           |          |
| 3x GU10 Socket | 105.05.01 | € 878.00 |

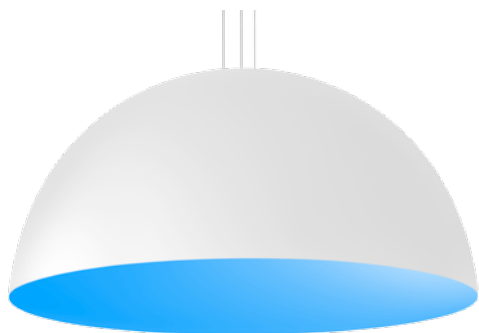

**Dome**  
RGB

|                                       |               |          |
|---------------------------------------|---------------|----------|
| <b>GU10 + LEDstrip (incl. remote)</b> |               |          |
| 3x GU10 Socket                        | 105.05.01-RGB | €1072.00 |

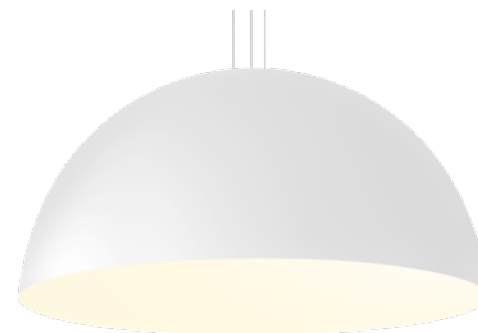

**Dome**  
Fortimo

|  |                      |           |
|--|----------------------|-----------|
| <b>3x Philips Fortimo SLM 2000lm - 24° - Non dim.</b>            |                      |           |
| Ra90 - 3000K - 3x17.4W - 97-84lm/W                               | 105.6000.24.930.01-C | € 1193.00 |
| <b>3x Philips Fortimo SLM 2000lm - 24°- Touch DIM &amp; DALI</b> |                      |           |
| Ra90 - 3000K - 3x17.4W - 97-84lm/W                               | 105.6000.24.930.01-D | € 1355.00 |

**LED vs. system efficacy**  
 Ra00 - 0000K - 00.0W - 000-000lm/W  
 LED efficacy ┌ System efficacy

# Tube

Type  
Material

Surface Mounted / Recessed  
Steel frame + Polyethylene

T5

Ballast Incl.  
T5 Lightsources not incl.  
Power:

21/39W

Recessed frame measurements:  
1150mm x 90mm  
Build in depth: min.40mm



↑  
Tube length:  
950mm  
↓

↙  
Tube diameter:  
ø 80mm





### Tube

#### Surface Mounted

|                            |              |          |
|----------------------------|--------------|----------|
| 1x T5 21/39W non dim       | 384.24.21/39 | € 272.00 |
| 1x T5 39W 1-10V dim        | 384.25.39    | € 302.00 |
| 1x T5 39W Touch DIM & DALI | 384.26.39    | € 313.00 |



### Tube

#### Recessed

|                            |              |          |
|----------------------------|--------------|----------|
| 1x T5 21/39W non dim       | 322.24.21/39 | € 364.00 |
| 1x T5 39W 1-10V dim        | 322.25.39    | € 394.00 |
| 1x T5 39W Touch DIM & DALI | 322.26.39    | € 404.00 |

# Globe / Eclipse

## Surface Mounted

Type Surface Mounted  
 Material Polyethylene + Aluminium frame

**E27**  
 Lightsource not included  
 Socket E27

**LED-Line 1250lm**  
 LED incl.  
 LED Driver(s) incl. Power 8.6W  
 Lm output 1250  
 Color temp 3000K  
 CRI Ra80  
 SDCM 3.5  
 Lifetime 50.000 Hrs (70%)

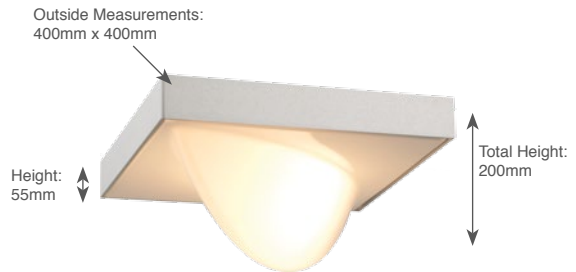

### Options

|                          |           |          |
|--------------------------|-----------|----------|
| Frame matt white texture | 146.00.01 | € 120.00 |
| Frame Aluminium brushed  | 146.00.06 | € 120.00 |

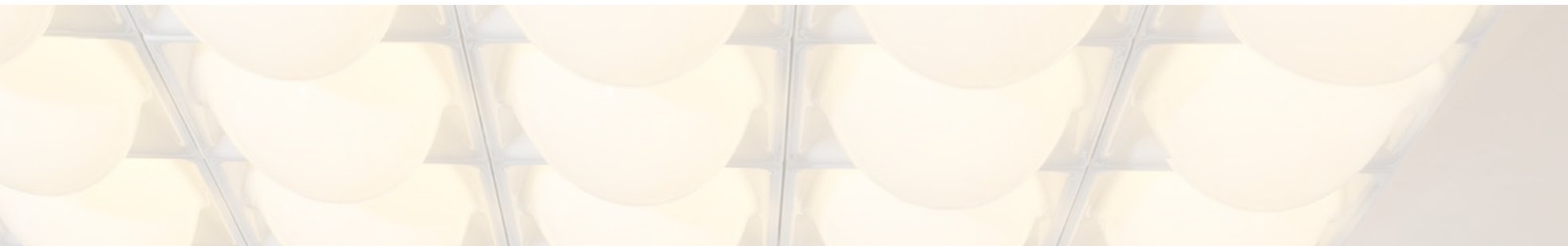

**Globe\***  
Surface Mounted

|                        |                 |          |  |
|------------------------|-----------------|----------|--|
| <b>E27</b>             |                 |          |  |
| E27 Socket             | 146.38.10       | € 125.00 |  |
| <b>LED-Line 1250lm</b> |                 |          |  |
| Touch DIM & DALI       | 146.26.1250.830 | € 260.00 |  |

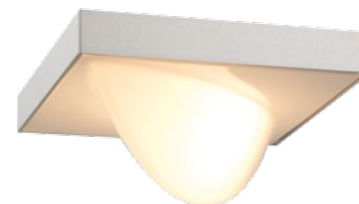

**Eclipse\***  
Surface Mounted

|                        |                 |          |  |
|------------------------|-----------------|----------|--|
| <b>E27</b>             |                 |          |  |
| E27 Socket             | 143.38.10       | € 125.00 |  |
| <b>LED-Line 1250lm</b> |                 |          |  |
| Touch DIM & DALI       | 143.26.1250.830 | € 260.00 |  |

\*Photo: with optional frame (std not incl.)



# Globe / Eclipse Suspended

Type

Material

Suspension set incl.

**2x LED-Line 1250lm**

LED incl.

LED Driver(s) incl.

Power

Lm output

Color temp

CRI

SDCM

Lifetime

Surface Mounted / Recessed  
Polyethylene + Aluminium frame

(2x) 8.6W

(2x) 1250

3000K

Ra80

3.5

50.000 Hrs (70%)

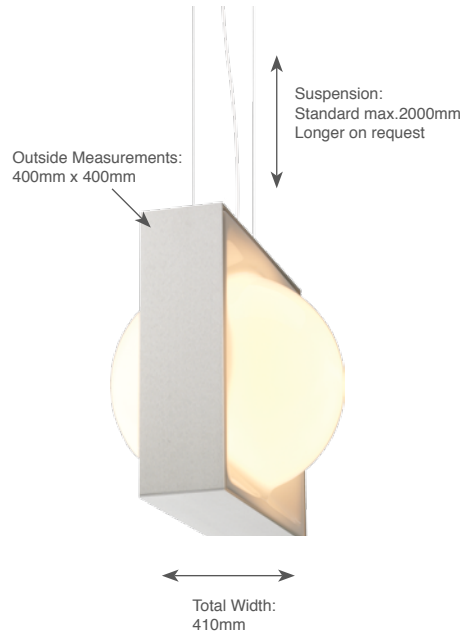



**Globe**  
Suspended

**LED-Line 2500lm**  
Non dimmable  
1-10V dimmable  
Touch DIM & DALI

145.24.2500.830  
145.25.2500.830  
145.26.2500.830

€ 560.00  
€ 603.00  
€ 607.00



**Eclipse**  
Suspended

**LED-Line 2500lm**  
Non dimmable  
1-10V dimmable  
Touch DIM & DALI

142.24.2500.830  
142.25.2500.830  
142.26.2500.830

€ 560.00  
€ 603.00  
€ 607.00

# Palladium / Palladino

Type  
Material  
Suspension set incl.  
Suspended / Surface Mounted  
Polyethylene (850°C)

## TC-L 55W

Lightsources not incl.  
Ballast incl.  
Only to be used with Philips TC-L 55W

## E27

Lightsources not incl.

## LEDstrip

LEDstrip + Remote incl.   
LEDstrip driver incl.

## GU10 socket

Lightsources not incl.  
Power max.50W  
Socket GU10

## T5

T5 Lightsources not incl.  
Ballast Incl.  
Power: 21/39W

## T5 24W RGB Master/Slave

Lightsources not incl.   
Remote control incl.  
1 Master to control max. 9 Slaves  
Master with integrated RGB sequencer (looping)  
DMX compatible

### Palladium:

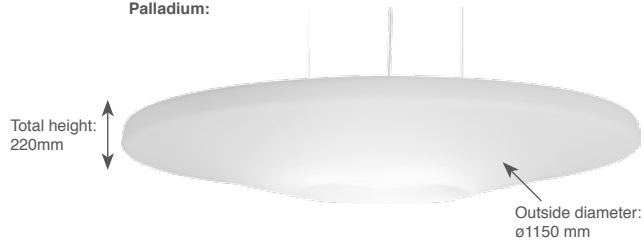

### Palladino:

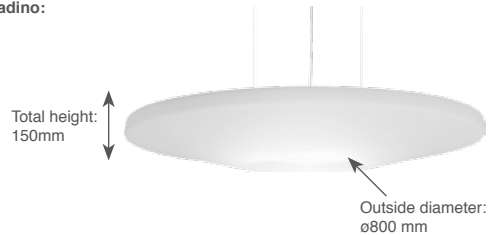

## Options

| Suspension options: |                   |         |
|---------------------|-------------------|---------|
| Suspension 1        | standard supplied |         |
| Suspension 2        | 340.00.02         | € 36.20 |
| Suspension 3        | 340.00.03         | € 28.30 |

Separately circuit for Palladium T2 downlights:  
Separately supply T2 650.00.01 €28.10

### Suspension 1 (standard supplied):

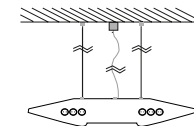

### Suspension 2:

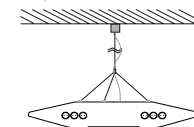

### Suspension 3:

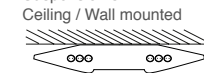

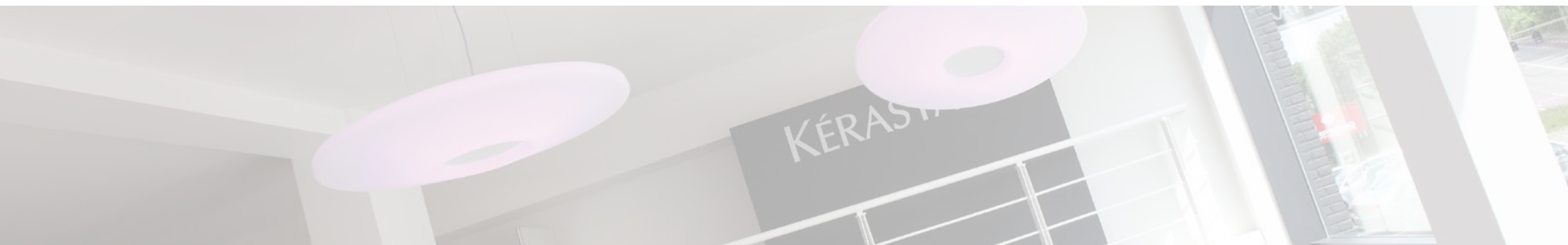

### Palladino

|             |               |          |
|-------------|---------------|----------|
| <b>LED</b>  |               |          |
| 3000K - 42W | 341.19.00     | € 560.00 |
| RGB - 65W   | 341.30.65.RGB | € 664.00 |



### Palladium

|                      |               |           |
|----------------------|---------------|-----------|
| <b>4x T5 14/24W</b>  |               |           |
| Non dimmable         | 336.24.24     | € 806.10  |
| 1-10V dimmable       | 336.25.24     | € 915.86  |
| Touch DIM & DALI     | 336.26.24     | € 936.15  |
| <b>6x T5 14/24W</b>  |               |           |
| Non dimmable         | 340.24.24     | € 874.12  |
| 1-10V dimmable       | 340.25.24     | € 1038.63 |
| Touch DIM & DALI     | 340.26.24     | € 1069.90 |
| <b>4x TC-L 55W</b>   |               |           |
| Non dimmable         | 336.24.55     | € 840.55  |
| 1-10V dimmable       | 336.25.55     | € 1002.85 |
| Touch DIM & DALI     | 336.26.55     | € 1024.46 |
| <b>5x E27</b>        |               |           |
| E27 Socket           | 352.24.00     | € 705.59  |
| <b>6x T5 24W RGB</b> |               |           |
| Slave                | 340.27.24     | € 1171.81 |
| Master               | 340.30.24     | € 1846.23 |
| <b>LED</b>           |               |           |
| RGB - 90W            | 340.30.90.RGB | € 995.00  |



### Palladium T2

|                                       |           |           |
|---------------------------------------|-----------|-----------|
| <b>4x T5 14/24W + 3x GU10 socket</b>  |           |           |
| Non dimmable                          | 325.24.24 | € 1025.90 |
| 1-10V dimmable                        | 325.25.24 | € 1133.70 |
| Touch DIM & DALI                      | 325.26.24 | € 1152.86 |
| <b>6x T5 14/24W + 3x GU10 socket</b>  |           |           |
| Non dimmable                          | 376.24.24 | € 1101.13 |
| 1-10V dimmable                        | 376.25.24 | € 1163.67 |
| Touch DIM & DALI                      | 376.26.24 | € 1295.88 |
| <b>4x TC-L 55W + 3x GU10 socket</b>   |           |           |
| Non dimmable                          | 376.24.55 | € 1068.59 |
| 1-10V dimmable                        | 376.25.55 | € 1229.86 |
| Touch DIM & DALI                      | 376.26.55 | € 1250.44 |
| <b>6x T5 24W RGB + 3x GU10 socket</b> |           |           |
| Slave                                 | 376.27.24 | € 1343.20 |
| Master                                | 376.30.24 | € 1964.50 |











# Outdoor

**Terra**  
Terra HIT..... 122  
Terra HIT Asym..... 122  
Terra Round..... 122  
Terra Square..... 122

**Vertex**  
Vertex Up / Down..... 124  
Vertex Double Down..... 124  
Vertex Down..... 124

**Radar**  
Radar Superlow..... 126

**Diva**  
Diva..... 128

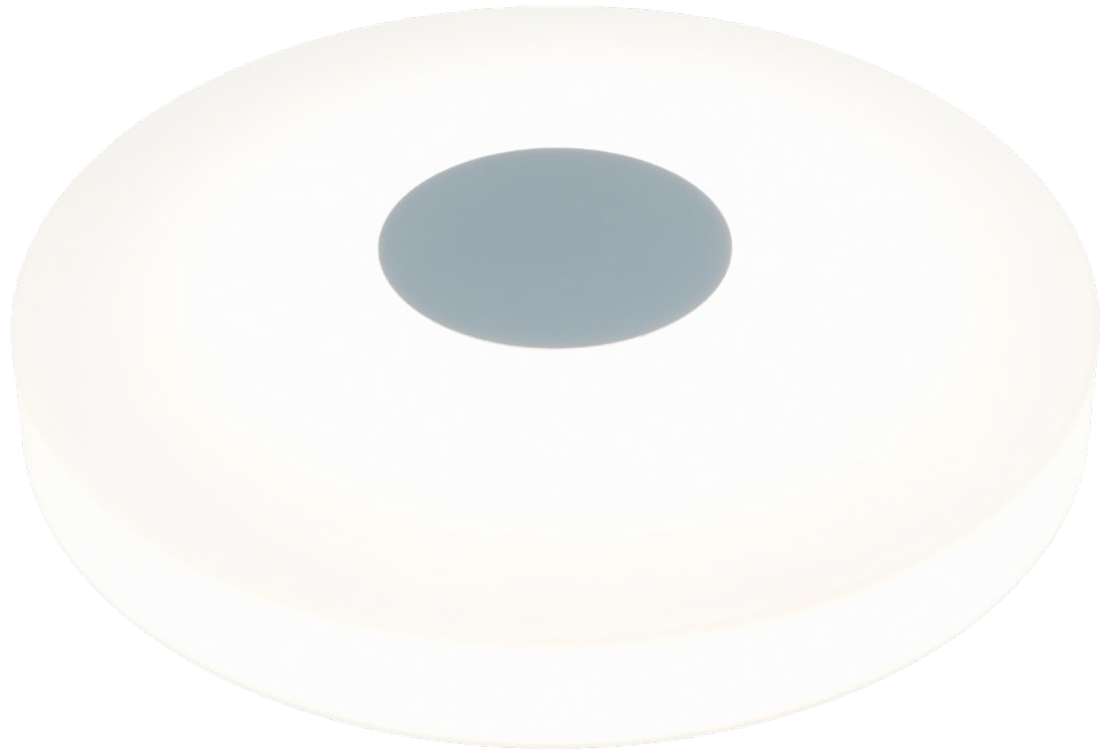

# Terra

Type  
Material

Ground spot  
Housing: Aluminium  
Front: Stainless steel  
Pre-housing: Polypropylene  
IP67  
Max. 2000kg

IP code  
Load:

## GU10

Lightsource not incl.  
Power  
Socket

max.35W  
GU10

## G12

Lightsource not incl.  
Ballast 70W incl.  
Socket

G12

## RX7s

Lightsource not incl.  
Ballast 70W incl.  
Socket

RX7S

## Terra HIT (Asym.)



## Terra Round / Square



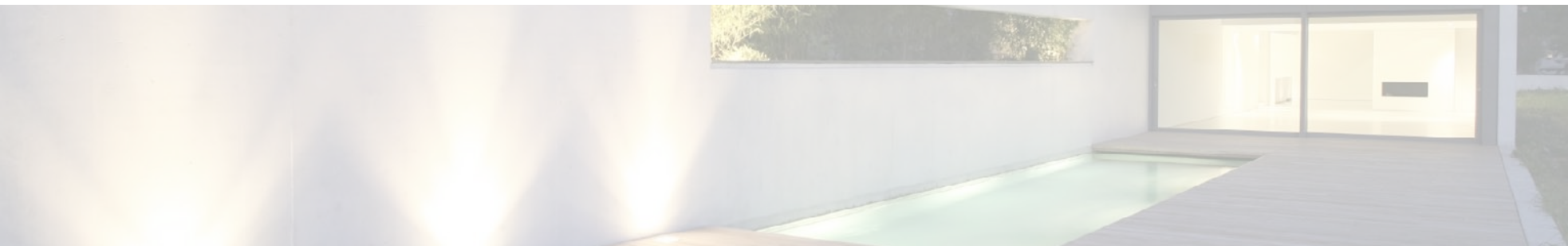

Terra Round HIT  
G12 232.22.16 € 403.45



Terra Round HIT Asym  
RX7s 233.22.16 € 424.96



Terra Round  
GU10 231.05.16 € 144.70



Terra Square  
GU10 234.05.16 € 144.70

# Vertex

Type  
Material  
IP code

Surface Mounted  
Aluminum  
IP54

## GU10

Lightsource incl.  
Lightsource  
Power  
Socket  
Color temp.  
Lumen output  
Dimmability

Megaman MM3596  
6W  
GU10  
2800K  
300lm  
Dimmable (10-100%)

All aluminium parts are first technically anodised to prevent corrosion. After this proces, all parts are grey aluminium coated.

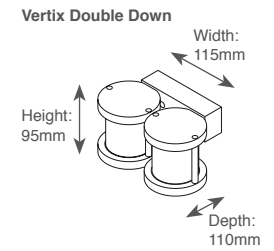
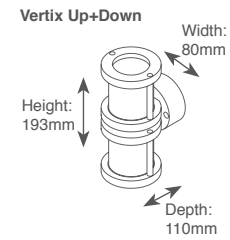
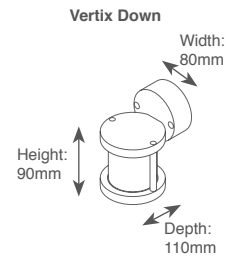

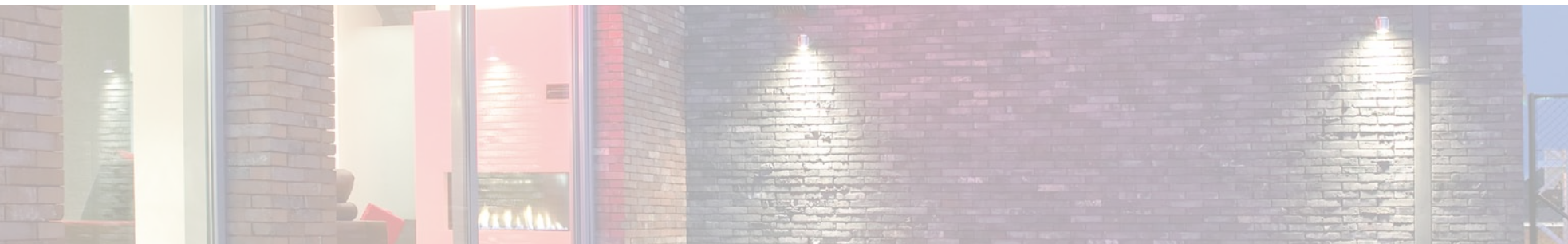

Vertex  
Up/Down  
2x GU10 (6W LED incl.) 120.05.19 € 219.00



Vertex  
Double down  
2x GU10 (6W LED incl.) 124.05.19 € 219.00



Vertex  
Down  
1x GU10 (6W LED incl.) 122.05.19 € 149.00

Available colors: 00.00.xx  
19: Grey powdercoated  color



# Radars Superlow

Material Frame: Stainless steel  
Body: Polyethylene  
Color Grey powdercoated  
IP code IP54

## E27 + Megaman MM3824 Lightsource incl.

Lightsource MM3824 incl.  
Socket E27  
Power 7.5W  
Color temp. 2800K  
Lumen output 600lm





**Radar**  
Superlow

**E27**  
E27 + LED lightsource incl.    245.38.00    € 645.00

# Diva

Type Surface Mounted  
Material Aluminium  
Lamp Orientation Fixed  
IP Code IP54

## E27

Lightsource not incl.  
Socket E27

## E27 + Megaman MM3375 Lightsource incl.

Lightsource MM3375 incl.  
Diva)  
Socket E27  
Power 16W  
Color temp. 2800K  
Lumen output 950lm

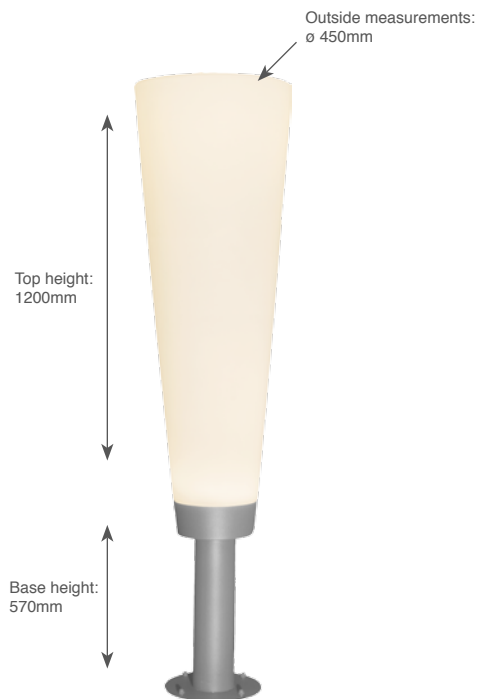



### Diva

|   |           |          |
|---|-----------|----------|
| <b>E27</b>                              |           |          |
| E27 socket                              | 252.00.00 | € 691.00 |
| <b>E27 + MM3375 lightsource (incl.)</b> |           |          |
| E27 + LED Lightsource incl.             | 252.00.00 | € 750.00 |

We offer 2 types of profiles:



### Ready To Go Solutions:

- Ready To Go Profiles
- All accessories included
- Pre-defined lengths



### Custom made Solutions:

- All shapes, lengths, colors, combinations, etc. upon request
- Download our latest catalogue (PDF) on [www.doxis.be](http://www.doxis.be)
- Ask a quotation at [info@doxis.be](mailto:info@doxis.be)

This catalogue only covers Ready To Go solutions.  
For custom made solutions download our Profiles catalogue at [www.doxis.be](http://www.doxis.be).

# Profiles Ready To Go

## Recessed

|                           |     |
|---------------------------|-----|
| <b>LEDLiner 45</b>        |     |
| LEDLiner 45 Recessed..... | 132 |
| <b>LEDLiner 65</b>        |     |
| LEDLiner 65 Recessed..... | 134 |

## Suspended

|                              |     |
|------------------------------|-----|
| <b>LEDLiner 45</b>           |     |
| LEDLiner 45 Down .....       | 136 |
| LEDLiner 45 Up / Down.....   | 138 |
| <b>LEDLiner 65</b>           |     |
| LEDLiner 65 Down .....       | 142 |
| <b>LEDLiner 140</b>          |     |
| LEDLiner 140 Down .....      | 144 |
| <b>LEDLiner 190</b>          |     |
| LEDLiner 190 Down .....      | 146 |
| LEDLiner 190 + FlatLED ..... | 148 |
| <b>Amazon</b>                |     |
| Amazon Down .....            | 150 |
| Amazon Down + Titan .....    | 152 |
| Amazon Titan.....            | 152 |

## Ceiling Mounted

|                              |     |
|------------------------------|-----|
| <b>LEDLiner 20</b>           |     |
| LEDLiner 20.....             | 154 |
| <b>LEDLiner 45</b>           |     |
| LEDLiner 45 Down .....       | 138 |
| <b>LEDLiner 65</b>           |     |
| LEDLiner 65 Down .....       | 142 |
| <b>LEDLiner 140</b>          |     |
| LEDLiner 140 Down .....      | 144 |
| <b>LEDLiner 190</b>          |     |
| LEDLiner 190 Down .....      | 146 |
| LEDLiner 190 + FlatLED ..... | 148 |

## Wall Mounted

|                              |     |
|------------------------------|-----|
| <b>LEDLiner 20</b>           |     |
| LEDLiner 20.....             | 154 |
| <b>LEDLiner 45</b>           |     |
| LEDLiner 45 Wall.....        | 140 |
| <b>LEDLiner 65</b>           |     |
| LEDLiner 65 Down .....       | 142 |
| <b>LEDLiner 190</b>          |     |
| LEDLiner 190 Down .....      | 146 |
| LEDLiner 190 + FlatLED ..... | 148 |

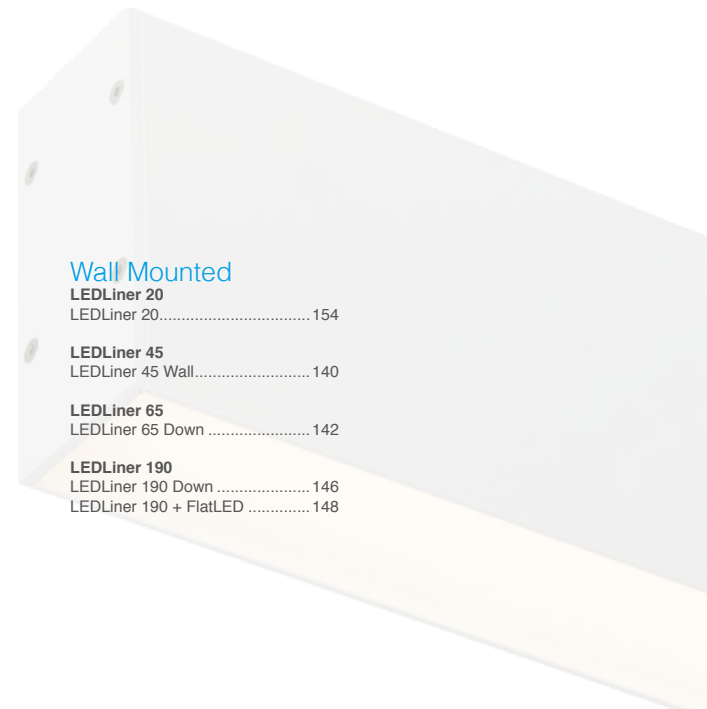



# LEDLiner45 Recessed

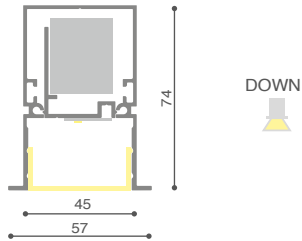

### LEDLiner45 Recessed

Recessed aluminium extruded profile 45x74mm. Strong attention is given to thermal management (reduction of heat).

LEDLiner45 Recessed offers the latest and best performing LED lighting technology using Philips LED-Strips. The polycarbonate cover can be set into 2 different positions: 10mm recessed or flush with the border of the profile.

|          |                  |
|----------|------------------|
| Type     | Recessed Profile |
| Material | Aluminium        |

### Philips Fortimo LED-Strip

|                   |            |
|-------------------|------------|
| Efficiency        | 126lm/W    |
| CRI               | Ra80       |
| Color Temperature | 3000K      |
| Lifetime          | 50.000 Hrs |

5 Years **Philips** Warranty



### Options

|                          |              |          |
|--------------------------|--------------|----------|
| Actilume Daylight Sensor | 659.00.00    | € 213.00 |
| Emergency Lighting 1Hr   | 659.00.LED-1 | € 275.00 |
| Emergency Lighting 3Hrs  | 659.00.LED-3 | € 325.00 |

### On Request

Custom made lengths & shapes (see profiles catalogue)  
Other RAL colors  
Wiring other than standard (see p.165)

### Included

Profile  
End Caps  
LED Modules  
Recessed Mounting Brackets  
PC Cover down matt

### 2 PC positions possible:

All LEDLiner 45 Recessed RTG profiles do have standard the possibility of changing from PC in to PC flush.



PC In



PC Flush

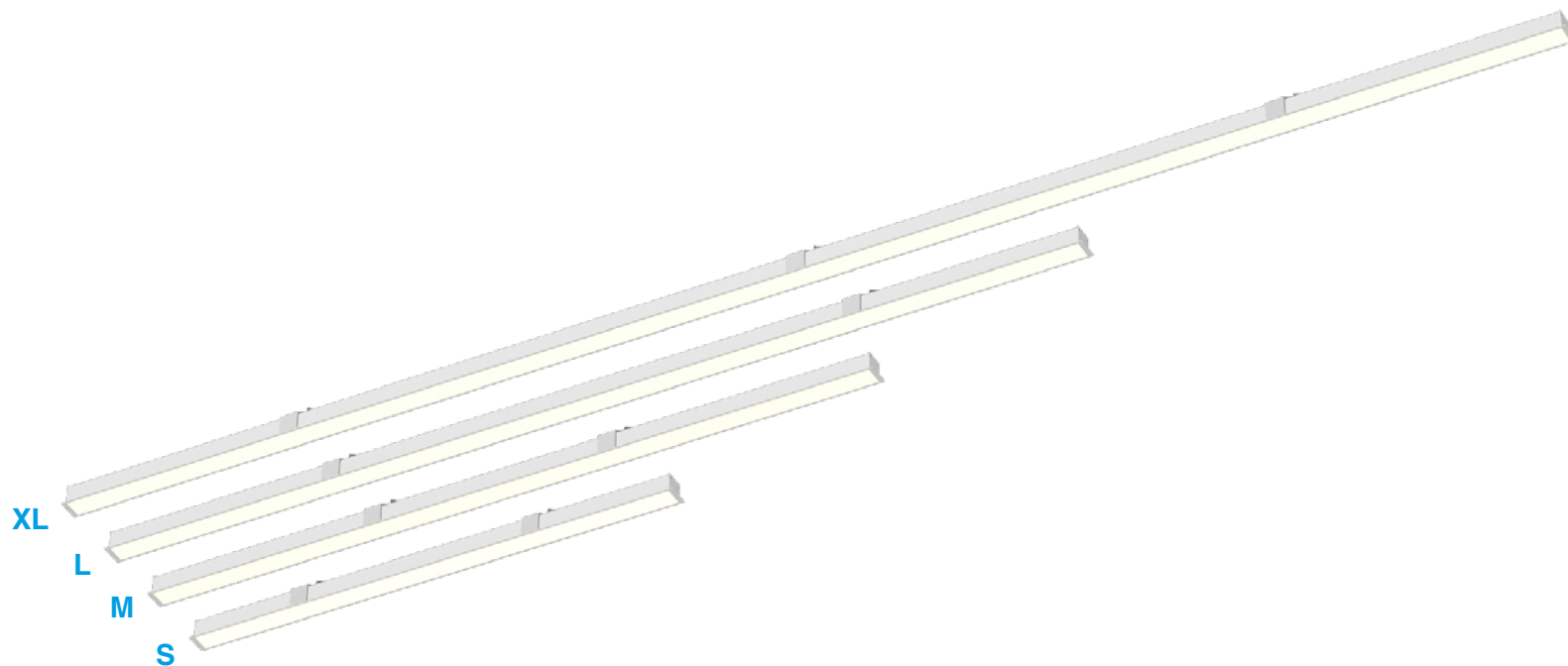

## LEDLiner45 Recessed

Non dimmable

### Matt White Texture

|           |                         |                 |          |
|-----------|-------------------------|-----------------|----------|
| <b>S</b>  | 1168mm / 2600lm / 19.6W | 760.24.01.RTG.1 | € 409.00 |
| <b>M</b>  | 1731mm / 3900lm / 29.4W | 760.24.01.RTG.2 | € 537.00 |
| <b>L</b>  | 2302mm / 5200lm / 39.2W | 760.24.01.RTG.3 | € 677.00 |
| <b>XL</b> | 2865mm / 6500lm / 49.0W | 760.24.01.RTG.4 | € 805.00 |

### Aluminium Anodised

|           |                         |                 |          |
|-----------|-------------------------|-----------------|----------|
| <b>S</b>  | 1168mm / 2600lm / 19.6W | 760.24.10.RTG.1 | € 380.00 |
| <b>M</b>  | 1731mm / 3900lm / 29.4W | 760.24.10.RTG.2 | € 496.00 |
| <b>L</b>  | 2302mm / 5200lm / 39.2W | 760.24.10.RTG.3 | € 621.00 |
| <b>XL</b> | 2865mm / 6500lm / 49.0W | 760.24.10.RTG.4 | € 736.00 |

## LEDLiner45 Recessed

1-10V dimmable

### Matt White Texture

|           |                         |                 |          |
|-----------|-------------------------|-----------------|----------|
| <b>S</b>  | 1168mm / 2600lm / 19.6W | 760.25.01.RTG.1 | € 492.00 |
| <b>M</b>  | 1731mm / 3900lm / 29.4W | 760.25.01.RTG.2 | € 620.00 |
| <b>L</b>  | 2302mm / 5200lm / 39.2W | 760.25.01.RTG.3 | € 762.00 |
| <b>XL</b> | 2865mm / 6500lm / 49.0W | 760.25.01.RTG.4 | € 890.00 |

### Aluminium Anodised

|           |                         |                 |          |
|-----------|-------------------------|-----------------|----------|
| <b>S</b>  | 1168mm / 2600lm / 19.6W | 760.25.10.RTG.1 | € 462.00 |
| <b>M</b>  | 1731mm / 3900lm / 29.4W | 760.25.10.RTG.2 | € 578.00 |
| <b>L</b>  | 2302mm / 5200lm / 39.2W | 760.25.10.RTG.3 | € 706.00 |
| <b>XL</b> | 2865mm / 6500lm / 49.0W | 760.25.10.RTG.4 | € 821.00 |

## LEDLiner45 Recessed

DALI dimmable

### Matt White Texture

|           |                         |                 |          |
|-----------|-------------------------|-----------------|----------|
| <b>S</b>  | 1168mm / 2600lm / 19.6W | 760.26.01.RTG.1 | € 499.00 |
| <b>M</b>  | 1731mm / 3900lm / 29.4W | 760.26.01.RTG.2 | € 627.00 |
| <b>L</b>  | 2302mm / 5200lm / 39.2W | 760.26.01.RTG.3 | € 770.00 |
| <b>XL</b> | 2865mm / 6500lm / 49.0W | 760.26.01.RTG.4 | € 898.00 |

### Aluminium Anodised

|           |                         |                 |          |
|-----------|-------------------------|-----------------|----------|
| <b>S</b>  | 1168mm / 2600lm / 19.6W | 760.26.10.RTG.1 | € 470.00 |
| <b>M</b>  | 1731mm / 3900lm / 29.4W | 760.26.10.RTG.2 | € 586.00 |
| <b>L</b>  | 2302mm / 5200lm / 39.2W | 760.26.10.RTG.3 | € 713.00 |
| <b>XL</b> | 2865mm / 6500lm / 49.0W | 760.26.10.RTG.4 | € 829.00 |

# LEDLiner65

## Recessed

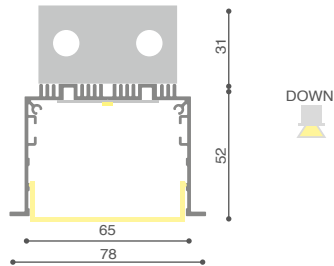

### LEDLiner 65 Recessed

Recessed aluminium extruded profile 65mm. Strong attention is given to thermal management (reduction of heat) and equal light distribution (Prismatic Optics).

LEDLiner65 Recessed offers the latest and best performing LED lighting technology using Philips LED-Lines. The polycarbonate cover can be set into 2 different positions: 10mm recessed or flush with the border of the profile.

|          |                  |
|----------|------------------|
| Type     | Recessed Profile |
| Material | Aluminium        |

|                                    |            |
|------------------------------------|------------|
| <b>Philips Fortimo LED-Line HV</b> |            |
| Efficiency                         | 135lm/W    |
| CRI                                | Ra80       |
| Color Temperature                  | 3000K      |
| Lifetime                           | 50.000 Hrs |

5 Years **Philips** Warranty

### 2 PC positions possible:

All LEDLiner 65 Recessed RTG profiles do have standard the possibility of changing from PC in to PC flush.



PC In



PC Flush



Mounting Bracket

### Options

|                          |              |          |
|--------------------------|--------------|----------|
| Actilume Daylight Sensor | 659.00.00    | € 213.00 |
| Emergency Lighting 1Hr   | 659.00.LED-1 | € 275.00 |
| Emergency Lighting 3Hrs  | 659.00.LED-3 | € 325.00 |

### On Request

Custom made lengths & shapes (see profiles catalogue)  
Other RAL colors  
Wiring other than standard (see p.165)

### Included

Profile  
End Caps  
LED Modules  
Recessed Mounting Brackets  
PC Cover down matt

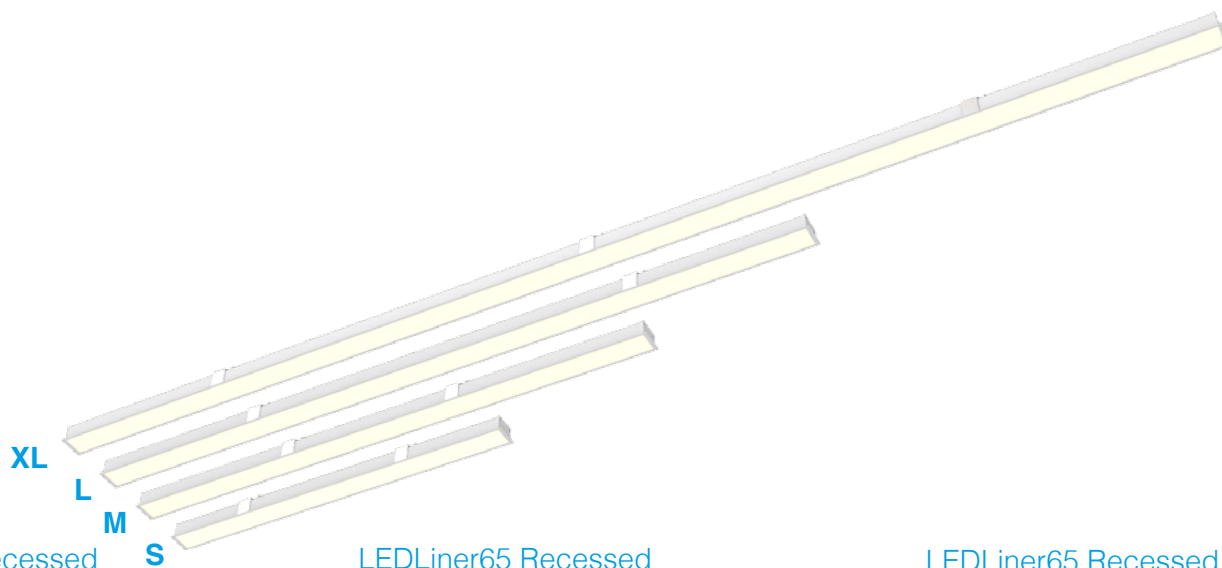

## LEDLiner65 Recessed

Non dimmable

### Matt White Texture

|           |                          |                 |          |
|-----------|--------------------------|-----------------|----------|
| <b>S</b>  | 1177mm / 4400lm / 32.4W  | 751.24.01.RTG.1 | € 320.00 |
| <b>M</b>  | 1738mm / 6600lm / 48.6W  | 751.24.01.RTG.2 | € 413.00 |
| <b>L</b>  | 2301mm / 8800lm / 64.8W  | 751.24.01.RTG.3 | € 582.00 |
| <b>XL</b> | 3434mm / 13200lm / 97.2W | 751.24.01.RTG.4 | € 768.00 |

### Aluminium Anodised

|           |                          |                 |          |
|-----------|--------------------------|-----------------|----------|
| <b>S</b>  | 1177mm / 4400lm / 32.4W  | 751.24.10.RTG.1 | € 318.00 |
| <b>M</b>  | 1738mm / 6600lm / 48.6W  | 751.24.10.RTG.2 | € 411.00 |
| <b>L</b>  | 2301mm / 8800lm / 64.8W  | 751.24.10.RTG.3 | € 579.00 |
| <b>XL</b> | 3434mm / 13200lm / 97.2W | 751.24.10.RTG.4 | € 765.00 |

## LEDLiner65 Recessed

1-10V dimmable

### Matt White Texture

|           |                          |                 |          |
|-----------|--------------------------|-----------------|----------|
| <b>S</b>  | 1177mm / 4400lm / 32.4W  | 751.25.01.RTG.1 | € 387.00 |
| <b>M</b>  | 1738mm / 6600lm / 48.6W  | 751.25.01.RTG.2 | € 480.00 |
| <b>L</b>  | 2301mm / 8800lm / 64.8W  | 751.25.01.RTG.3 | € 717.00 |
| <b>XL</b> | 3434mm / 13200lm / 97.2W | 751.25.01.RTG.4 | € 903.00 |

### Aluminium Anodised

|           |                          |                 |          |
|-----------|--------------------------|-----------------|----------|
| <b>S</b>  | 1177mm / 4400lm / 32.4W  | 751.25.10.RTG.1 | € 386.00 |
| <b>M</b>  | 1738mm / 6600lm / 48.6W  | 751.25.10.RTG.2 | € 478.00 |
| <b>L</b>  | 2301mm / 8800lm / 64.8W  | 751.25.10.RTG.3 | € 714.00 |
| <b>XL</b> | 3434mm / 13200lm / 97.2W | 751.25.10.RTG.4 | € 900.00 |

## LEDLiner65 Recessed

Dali dimmable

### Matt White Texture

|           |                          |                 |          |
|-----------|--------------------------|-----------------|----------|
| <b>S</b>  | 1177mm / 4400lm / 32.4W  | 751.26.01.RTG.1 | € 392.00 |
| <b>M</b>  | 1738mm / 6600lm / 48.6W  | 751.26.01.RTG.2 | € 485.00 |
| <b>L</b>  | 2301mm / 8800lm / 64.8W  | 751.26.01.RTG.3 | € 727.00 |
| <b>XL</b> | 3434mm / 13200lm / 97.2W | 751.26.01.RTG.4 | € 913.00 |

### Aluminium Anodised

|           |                          |                 |          |
|-----------|--------------------------|-----------------|----------|
| <b>S</b>  | 1177mm / 4400lm / 32.4W  | 751.26.10.RTG.1 | € 391.00 |
| <b>M</b>  | 1738mm / 6600lm / 48.6W  | 751.26.10.RTG.2 | € 483.00 |
| <b>L</b>  | 2301mm / 8800lm / 64.8W  | 751.26.10.RTG.3 | € 724.00 |
| <b>XL</b> | 3434mm / 13200lm / 97.2W | 751.26.10.RTG.4 | € 910.00 |

# LEDLiner45 Down

Suspended / Surface Mounted

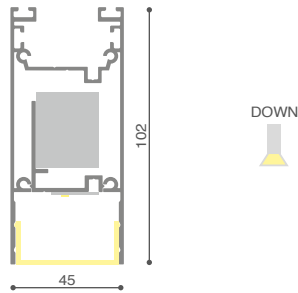

### LEDLiner 45

Aluminium extruded profile 45x102 mm for ceiling, wall or suspended mounting solutions. Strong attention is given to thermal management (reduction of heat).

**LEDLiner45** offers the latest and best performing LED lighting technology using Philips LED-Strips.

These LED-Strips can be used as direct lighting or combined direct/indirect lighting.

The polycarbonate cover can be set into 2 different positions: 10mm recessed or flush with the border of the profile.

|          |                                     |
|----------|-------------------------------------|
| Type     | Suspended / Surface Mounted Profile |
| Material | Aluminium                           |

### Philips Fortimo LED-Strip

|                   |            |
|-------------------|------------|
| Efficiency        | 126lm/W    |
| CRI               | Ra80       |
| Color Temperature | 3000K      |
| Lifetime          | 50.000 Hrs |

5 Years **Philips** Warranty

### 2 PC positions possible:

All LEDLiner 45 RTG profiles do have standard the possibility of changing from PC in to PC flush.



PC In



PC Flush



### Options

|                          |              |          |
|--------------------------|--------------|----------|
| Actilume Daylight Sensor | 659.00.00    | € 213.00 |
| Emergency Lighting 1Hr   | 659.00.LED-1 | € 275.00 |
| Emergency Lighting 3Hrs  | 659.00.LED-3 | € 325.00 |
| Wall Bracket (1pc)       | 763.00.00    | € 30.00  |

### On Request

Custom made lengths & shapes (see profiles catalogue)  
Other RAL colors  
Wiring other than standard (see p.165)

### Included

Profile  
End Caps  
LED Modules  
PC Cover down matt  
Standard "Y" suspension (2100mm) (Suspended version)  
Mounting connecting box (Suspended version)  
Power supply cable (2100mm) (Suspended version)



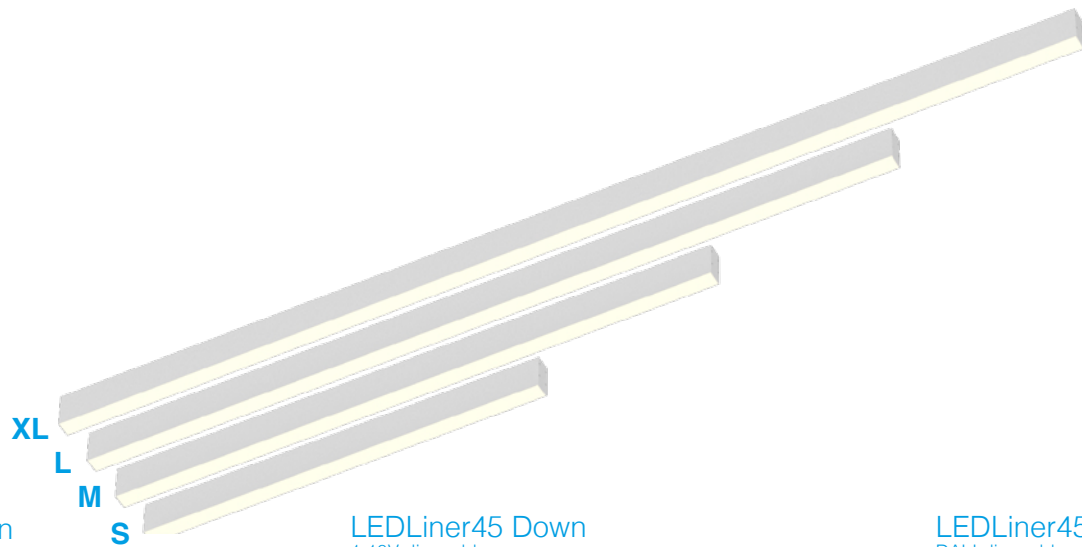

### LEDLiner45 Down

Non dimmable

| Matt White Texture - Suspended       |                         |                  |          |
|--------------------------------------|-------------------------|------------------|----------|
| S                                    | 1142mm / 2600lm / 19.6W | 750.24.01.RTG.1  | € 403.00 |
| M                                    | 1705mm / 3900lm / 29.4W | 750.24.01.RTG.2  | € 532.00 |
| L                                    | 2268mm / 5200lm / 39.2W | 750.24.01.RTG.3  | € 674.00 |
| XL                                   | 2831mm / 6500lm / 49.0W | 750.24.01.RTG.4  | € 804.00 |
| Matt White Texture - Surface mounted |                         |                  |          |
| S                                    | 1158mm / 2600lm / 19.6W | 750.24.01.RTG.12 | € 403.00 |
| M                                    | 1721mm / 3900lm / 29.4W | 750.24.01.RTG.13 | € 532.00 |
| L                                    | 2292mm / 5200lm / 39.2W | 750.24.01.RTG.14 | € 674.00 |
| XL                                   | 2855mm / 6500lm / 49.0W | 750.24.01.RTG.15 | € 804.00 |
| Aluminium anodised - Suspended       |                         |                  |          |
| S                                    | 1142mm / 2600lm / 19.6W | 750.24.10.RTG.1  | € 398.00 |
| M                                    | 1705mm / 3900lm / 29.4W | 750.24.10.RTG.2  | € 525.00 |
| L                                    | 2268mm / 5200lm / 39.2W | 750.24.10.RTG.3  | € 655.00 |
| XL                                   | 2831mm / 6500lm / 49.0W | 750.24.10.RTG.4  | € 792.00 |
| Aluminium anodised - Surface mounted |                         |                  |          |
| S                                    | 1158mm / 2600lm / 19.6W | 750.24.10.RTG.12 | € 398.00 |
| M                                    | 1721mm / 3900lm / 29.4W | 750.24.10.RTG.13 | € 525.00 |
| L                                    | 2292mm / 5200lm / 39.2W | 750.24.10.RTG.14 | € 655.00 |
| XL                                   | 2855mm / 6500lm / 49.0W | 750.24.10.RTG.15 | € 792.00 |

### LEDLiner45 Down

1-10V dimmable

| Matt White Texture - Suspended       |                         |                  |          |
|--------------------------------------|-------------------------|------------------|----------|
| S                                    | 1142mm / 2600lm / 19.6W | 750.25.01.RTG.1  | € 503.00 |
| M                                    | 1705mm / 3900lm / 29.4W | 750.25.01.RTG.2  | € 633.00 |
| L                                    | 2268mm / 5200lm / 39.2W | 750.25.01.RTG.3  | € 777.00 |
| XL                                   | 2831mm / 6500lm / 49.0W | 750.25.01.RTG.4  | € 907.00 |
| Matt White Texture - Surface mounted |                         |                  |          |
| S                                    | 1158mm / 2600lm / 19.6W | 750.25.01.RTG.12 | € 503.00 |
| M                                    | 1721mm / 3900lm / 29.4W | 750.25.01.RTG.13 | € 633.00 |
| L                                    | 2292mm / 5200lm / 39.2W | 750.25.01.RTG.14 | € 777.00 |
| XL                                   | 2855mm / 6500lm / 49.0W | 750.25.01.RTG.15 | € 907.00 |
| Aluminium anodised - Suspended       |                         |                  |          |
| S                                    | 1142mm / 2600lm / 19.6W | 750.25.10.RTG.1  | € 498.00 |
| M                                    | 1705mm / 3900lm / 29.4W | 750.25.10.RTG.2  | € 626.00 |
| L                                    | 2268mm / 5200lm / 39.2W | 750.25.10.RTG.3  | € 767.00 |
| XL                                   | 2831mm / 6500lm / 49.0W | 750.25.10.RTG.4  | € 895.00 |
| Aluminium anodised - Surface mounted |                         |                  |          |
| S                                    | 1158mm / 2600lm / 19.6W | 750.25.10.RTG.12 | € 498.00 |
| M                                    | 1721mm / 3900lm / 29.4W | 750.25.10.RTG.13 | € 626.00 |
| L                                    | 2292mm / 5200lm / 39.2W | 750.25.10.RTG.14 | € 767.00 |
| XL                                   | 2855mm / 6500lm / 49.0W | 750.25.10.RTG.15 | € 895.00 |

### LEDLiner45 Down

DALI dimmable

| Matt White Texture - Suspended       |                         |                  |          |
|--------------------------------------|-------------------------|------------------|----------|
| S                                    | 1142mm / 2600lm / 19.6W | 750.26.01.RTG.1  | € 511.00 |
| M                                    | 1705mm / 3900lm / 29.4W | 750.26.01.RTG.2  | € 640.00 |
| L                                    | 2268mm / 5200lm / 39.2W | 750.26.01.RTG.3  | € 784.00 |
| XL                                   | 2831mm / 6500lm / 49.0W | 750.26.01.RTG.4  | € 914.00 |
| Matt White Texture - Surface mounted |                         |                  |          |
| S                                    | 1158mm / 2600lm / 19.6W | 750.26.01.RTG.12 | € 511.00 |
| M                                    | 1721mm / 3900lm / 29.4W | 750.26.01.RTG.13 | € 640.00 |
| L                                    | 2292mm / 5200lm / 39.2W | 750.26.01.RTG.14 | € 784.00 |
| XL                                   | 2855mm / 6500lm / 49.0W | 750.26.01.RTG.15 | € 914.00 |
| Aluminium anodised - Suspended       |                         |                  |          |
| S                                    | 1142mm / 2600lm / 19.6W | 750.26.10.RTG.1  | € 505.00 |
| M                                    | 1705mm / 3900lm / 29.4W | 750.26.10.RTG.2  | € 633.00 |
| L                                    | 2268mm / 5200lm / 39.2W | 750.26.10.RTG.3  | € 775.00 |
| XL                                   | 2831mm / 6500lm / 49.0W | 750.26.10.RTG.4  | € 903.00 |
| Aluminium anodised - Surface mounted |                         |                  |          |
| S                                    | 1158mm / 2600lm / 19.6W | 750.26.10.RTG.12 | € 505.00 |
| M                                    | 1721mm / 3900lm / 29.4W | 750.26.10.RTG.13 | € 633.00 |
| L                                    | 2292mm / 5200lm / 39.2W | 750.26.10.RTG.14 | € 775.00 |
| XL                                   | 2855mm / 6500lm / 49.0W | 750.26.10.RTG.15 | € 903.00 |



# LEDLiner45 Up+Down Suspended

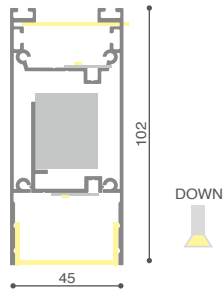

## LEDLiner 45

Aluminium extruded profile 45x102 mm for wall or suspended mounting solutions. Strong attention is given to thermal management (reduction of heat).

**LEDLiner45** offers the latest and best performing LED lighting technology using Philips LED-Strips. These LED-Strips can be used as direct lighting or combined direct/indirect lighting.

The polycarbonate cover can be set into 2 different positions: 10mm recessed or flush with the border of the profile.

|          |                   |
|----------|-------------------|
| Type     | Suspended Profile |
| Material | Aluminium         |

### Philips Fortimo LED-Strip

|                   |            |
|-------------------|------------|
| Efficiency        | 126lm/W    |
| CRI               | Ra80       |
| Color Temperature | 3000K      |
| Lifetime          | 50.000 Hrs |

5 Years **Philips** Warranty

### 2 PC positions possible:

All LEDLiner 45 RTG profiles do have standard the possibility of changing from PC in to PC flush.



PC In



PC Flush



## Options

|                          |              |          |
|--------------------------|--------------|----------|
| Actilume Daylight Sensor | 659.00.00    | € 213.00 |
| Emergency Lighting 1Hr   | 659.00.LED-1 | € 275.00 |
| Emergency Lighting 3Hrs  | 659.00.LED-3 | € 325.00 |
| Wall Bracket (1pc)       | 763.00.00    | € 30.00  |

## On Request

Custom made lengths & shapes (see profiles catalogue)  
Other RAL colors  
Wiring other than standard (see p.165)

## Included

Profile  
End Caps  
LED Modules  
PC Cover down matt  
PC Cover up clear  
Standard "Y" suspension (2100mm)  
Mounting connecting box  
Power supply cable (2100mm)

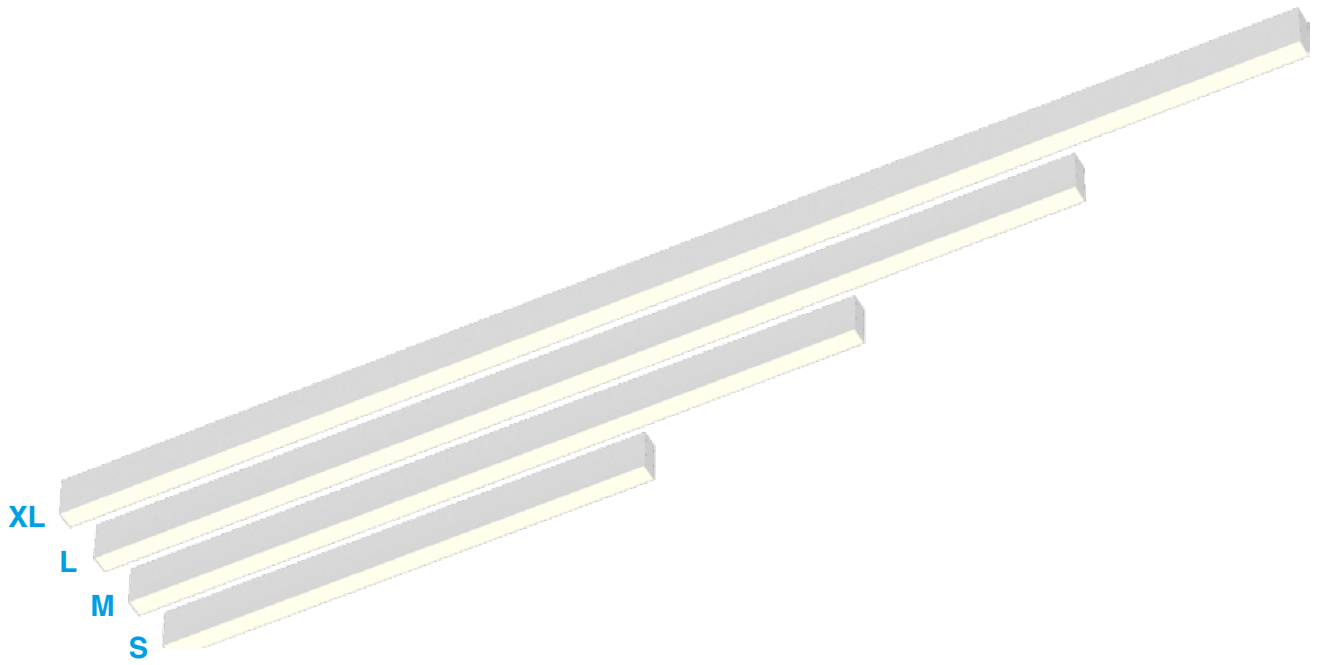

### LEDLiner45 Up+Down

Non dimmable

#### Matt White Texture

|           |                             |                 |           |
|-----------|-----------------------------|-----------------|-----------|
| <b>S</b>  | 1150mm / (2x)2600lm / 39.2W | 750.24.01.RTG.5 | € 643.00  |
| <b>M</b>  | 1713mm / (2x)3900lm / 58.8W | 750.24.01.RTG.6 | € 879.00  |
| <b>L</b>  | 2276mm / (2x)5200lm / 78.4W | 750.24.01.RTG.7 | € 1188.00 |
| <b>XL</b> | 2839mm / (2x)6500lm / 98.0W | 750.24.01.RTG.8 | € 1431.00 |

#### Aluminium Anodised

|           |                             |                 |           |
|-----------|-----------------------------|-----------------|-----------|
| <b>S</b>  | 1150mm / (2x)2600lm / 39.2W | 750.24.10.RTG.5 | € 621.00  |
| <b>M</b>  | 1713mm / (2x)3900lm / 58.8W | 750.24.10.RTG.6 | € 849.00  |
| <b>L</b>  | 2276mm / (2x)5200lm / 78.4W | 750.24.10.RTG.7 | € 1148.00 |
| <b>XL</b> | 2839mm / (2x)6500lm / 98.0W | 750.24.10.RTG.8 | € 1382.00 |

### LEDLiner45 Up+Down

1-10V dimmable

#### Matt White Texture

|           |                             |                 |           |
|-----------|-----------------------------|-----------------|-----------|
| <b>S</b>  | 1150mm / (2x)2600lm / 39.2W | 750.25.01.RTG.5 | € 728.00  |
| <b>M</b>  | 1713mm / (2x)3900lm / 58.8W | 750.25.01.RTG.6 | € 964.00  |
| <b>L</b>  | 2276mm / (2x)5200lm / 78.4W | 750.25.01.RTG.7 | € 1358.00 |
| <b>XL</b> | 2839mm / (2x)6500lm / 98.0W | 750.25.01.RTG.8 | € 1601.00 |

#### Aluminium Anodised

|           |                             |                 |           |
|-----------|-----------------------------|-----------------|-----------|
| <b>S</b>  | 1150mm / (2x)2600lm / 39.2W | 750.25.10.RTG.5 | € 706.00  |
| <b>M</b>  | 1713mm / (2x)3900lm / 58.8W | 750.25.10.RTG.6 | € 934.00  |
| <b>L</b>  | 2276mm / (2x)5200lm / 78.4W | 750.25.10.RTG.7 | € 1317.00 |
| <b>XL</b> | 2839mm / (2x)6500lm / 98.0W | 750.25.10.RTG.8 | € 1552.00 |

### LEDLiner45 Up+Down

DALI dimmable

#### Matt White Texture

|           |                             |                 |           |
|-----------|-----------------------------|-----------------|-----------|
| <b>S</b>  | 1150mm / (2x)2600lm / 39.2W | 750.26.01.RTG.5 | € 735.00  |
| <b>M</b>  | 1713mm / (2x)3900lm / 58.8W | 750.26.01.RTG.6 | € 971.00  |
| <b>L</b>  | 2276mm / (2x)5200lm / 78.4W | 750.26.01.RTG.7 | € 1373.00 |
| <b>XL</b> | 2839mm / (2x)6500lm / 98.0W | 750.26.01.RTG.8 | € 1616.00 |

#### Aluminium Anodised

|           |                             |                 |           |
|-----------|-----------------------------|-----------------|-----------|
| <b>S</b>  | 1150mm / (2x)2600lm / 39.2W | 750.26.10.RTG.5 | € 716.00  |
| <b>M</b>  | 1713mm / (2x)3900lm / 58.8W | 750.26.10.RTG.6 | € 941.00  |
| <b>L</b>  | 2276mm / (2x)5200lm / 78.4W | 750.26.10.RTG.7 | € 1332.00 |
| <b>XL</b> | 2839mm / (2x)6500lm / 98.0W | 750.26.10.RTG.8 | € 1567.00 |

# LEDLiner45

## Wall Mounted Up / Down

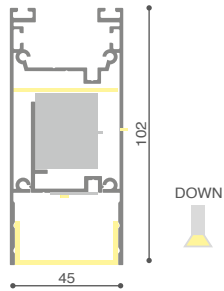

### LEDLiner 45

Aluminium extruded profile 45x102 mm for wall mounting solutions. Strong attention is given to thermal management (reduction of heat).

**LEDLiner45** offers the latest and best performing LED lighting technology using Philips LED-Strips.

These LED-Strips can be used as direct lighting or combined direct/indirect lighting.

The polycarbonate cover can be set into 2 different positions: 10mm recessed or flush with the border of the profile.

Type Wall Mounted Profile  
Material Aluminium

### Philips Fortimo LED-Strip

Efficiency 126lm/W  
CRI Ra80  
Color Temperature 3000K  
Lifetime 50.000 Hrs

5 Years **Philips** Warranty

### 2 PC positions possible:

All LEDLiner 45 RTG profiles do have standard the possibility of changing from PC in to PC flush.



PC In



PC Flush



### Options

|                          |              |          |
|--------------------------|--------------|----------|
| Actilume Daylight Sensor | 659.00.00    | € 213.00 |
| Emergency Lighting 1Hr   | 659.00.LED-1 | € 275.00 |
| Emergency Lighting 3Hrs  | 659.00.LED-3 | € 325.00 |

### On Request

Custom made lengths & shapes (see profiles catalogue)  
Other RAL colors  
Wiring other than standard (see p.165)

### Included

Profile  
End Caps  
LED Modules  
PC Cover down matt  
PC Cover up clear  
Wall bracket

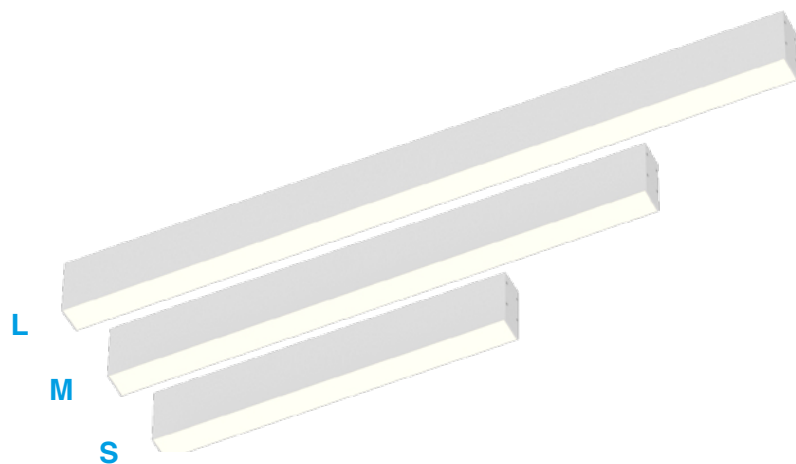
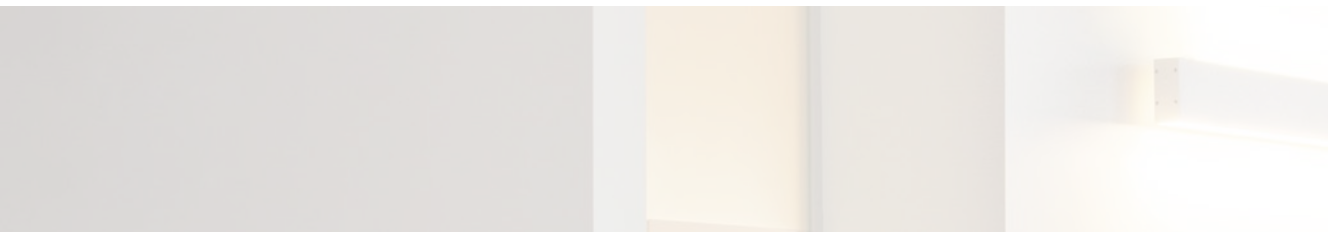

### LEDLiner45 Wall mounted U / D

Non dimmable

#### Matt White Texture

|                                      |                  |          |
|--------------------------------------|------------------|----------|
| <b>S</b> 580mm / (2x)1300lm / 19.6W  | 750.24.01.RTG.9  | € 418.00 |
| <b>M</b> 870mm / (2x)1950lm / 29.4W  | 750.24.01.RTG.10 | € 541.00 |
| <b>L</b> 1150mm / (2x)2600lm / 39.2W | 750.24.01.RTG.11 | € 643.00 |

#### Aluminium anodised

|                                      |                  |          |
|--------------------------------------|------------------|----------|
| <b>S</b> 580mm / (2x)1300lm / 19.6W  | 750.24.10.RTG.9  | € 379.00 |
| <b>M</b> 870mm / (2x)1950lm / 29.4W  | 750.24.10.RTG.10 | € 525.00 |
| <b>L</b> 1150mm / (2x)2600lm / 39.2W | 750.24.10.RTG.11 | € 627.00 |

### LEDLiner45 Wall mounted U / D

1-10V dimmable

#### Matt White Texture

|                                      |                  |          |
|--------------------------------------|------------------|----------|
| <b>S</b> 580mm / (2x)1300lm / 19.6W  | 750.25.01.RTG.9  | € 503.00 |
| <b>M</b> 870mm / (2x)1950lm / 29.4W  | 750.25.01.RTG.10 | € 626.00 |
| <b>L</b> 1150mm / (2x)2600lm / 39.2W | 750.25.01.RTG.11 | € 728.00 |

#### Aluminium anodised

|                                      |                  |          |
|--------------------------------------|------------------|----------|
| <b>S</b> 580mm / (2x)1300lm / 19.6W  | 750.25.10.RTG.9  | € 464.00 |
| <b>M</b> 870mm / (2x)1950lm / 29.4W  | 750.25.10.RTG.10 | € 610.00 |
| <b>L</b> 1150mm / (2x)2600lm / 39.2W | 750.25.10.RTG.11 | € 712.00 |

### LEDLiner45 Wall mounted U / D

DALI dimmable

#### Matt White Texture

|                                      |                  |          |
|--------------------------------------|------------------|----------|
| <b>S</b> 580mm / (2x)1300lm / 19.6W  | 750.26.01.RTG.9  | € 510.00 |
| <b>M</b> 870mm / (2x)1950lm / 29.4W  | 750.26.01.RTG.10 | € 633.00 |
| <b>L</b> 1150mm / (2x)2600lm / 39.2W | 750.26.01.RTG.11 | € 736.00 |

#### Aluminium anodised

|                                      |                  |          |
|--------------------------------------|------------------|----------|
| <b>S</b> 580mm / (2x)1300lm / 19.6W  | 750.26.10.RTG.9  | € 471.00 |
| <b>M</b> 870mm / (2x)1950lm / 29.4W  | 750.26.10.RTG.10 | € 617.00 |
| <b>L</b> 1150mm / (2x)2600lm / 39.2W | 750.26.10.RTG.11 | € 736.00 |

# LEDLiner65

Suspended / Surface Mounted

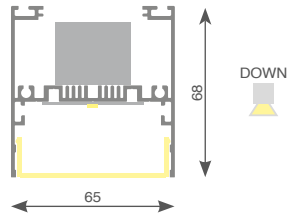

## LEDLiner65

Square aluminium extruded profile 65x68mm for ceiling, wall or suspended mounting solutions. Strong attention is given to thermal management (reduction of heat) and equal light distribution.

LEDLiner65 offers the latest and best performing LED lighting technology using Philips LED-Lines.

|          |  |
|----------|--|
| Type     | Suspended Profile<br>Surface Mounted Profile |
| Material | Aluminium                                    |

### Philips Fortimo LED-Line HV

|                   |            |
|-------------------|------------|
| Efficiency        | 135lm/W    |
| CRI               | Ra80       |
| Color Temperature | 3000K      |
| Lifetime          | 50.000 Hrs |

5 Years [Philips](#) Warranty

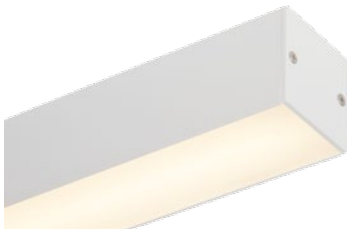

## Options

|                          |              |          |
|--------------------------|--------------|----------|
| Actilume Daylight Sensor | 659.00.00    | € 213.00 |
| Emergency Lighting 1Hr   | 659.00.LED-1 | € 275.00 |
| Emergency Lighting 3Hrs  | 659.00.LED-3 | € 325.00 |
| Wall Bracket (1pc)       | 764.00.00    | € 30.00  |

## On Request

Custom made lengths & shapes (see profiles catalogue)  
Other RAL colors  
Wiring other than standard (see p.165)

## Included

Profile  
End Caps  
LED Modules  
PC Cover down matt  
Standard "Y" suspension (2100mm) (Suspended version)  
Mounting connecting box (Suspended version)  
Power supply cable (2100mm) (Suspended version)



## LEDLiner65

Non dimmable

### Matt White Texture - Suspended

|           |                          |                 |          |
|-----------|--------------------------|-----------------|----------|
| <b>S</b>  | 1141mm / 4400lm / 32.4W  | 770.24.01.RTG.1 | € 332.00 |
| <b>M</b>  | 1704mm / 6600lm / 48.6W  | 770.24.01.RTG.2 | € 427.00 |
| <b>L</b>  | 2267mm / 8800lm / 64.8W  | 770.24.01.RTG.3 | € 598.00 |
| <b>XL</b> | 3392mm / 13200lm / 97.2W | 770.24.01.RTG.4 | € 787.00 |

### Matt White Texture - Surface Mounted

|           |                          |                 |          |
|-----------|--------------------------|-----------------|----------|
| <b>S</b>  | 1153mm / 4400lm / 32.4W  | 770.24.01.RTG.5 | € 332.00 |
| <b>M</b>  | 1716mm / 6600lm / 48.6W  | 770.24.01.RTG.6 | € 427.00 |
| <b>L</b>  | 2287mm / 8800lm / 64.8W  | 770.24.01.RTG.7 | € 598.00 |
| <b>XL</b> | 3412mm / 13200lm / 97.2W | 770.24.01.RTG.8 | € 787.00 |

### Aluminium Anodised - Suspended

|           |                          |                 |          |
|-----------|--------------------------|-----------------|----------|
| <b>S</b>  | 1141mm / 4400lm / 32.4W  | 770.24.10.RTG.1 | € 331.00 |
| <b>M</b>  | 1704mm / 6600lm / 48.6W  | 770.24.10.RTG.2 | € 425.00 |
| <b>L</b>  | 2267mm / 8800lm / 64.8W  | 770.24.10.RTG.3 | € 593.00 |
| <b>XL</b> | 3392mm / 13200lm / 97.2W | 770.24.10.RTG.4 | € 784.00 |

### Aluminium Anodised - Surface Mounted

|           |                          |                 |          |
|-----------|--------------------------|-----------------|----------|
| <b>S</b>  | 1153mm / 4400lm / 32.4W  | 770.24.10.RTG.5 | € 331.00 |
| <b>M</b>  | 1716mm / 6600lm / 48.6W  | 770.24.10.RTG.6 | € 425.00 |
| <b>L</b>  | 2287mm / 8800lm / 64.8W  | 770.24.10.RTG.7 | € 596.00 |
| <b>XL</b> | 3412mm / 13200lm / 97.2W | 770.24.10.RTG.8 | € 784.00 |

## LEDLiner65

1-10V dimmable

### Matt White Texture - Suspended

|           |                          |                 |          |
|-----------|--------------------------|-----------------|----------|
| <b>S</b>  | 1141mm / 4400lm / 32.4W  | 770.25.01.RTG.1 | € 418.00 |
| <b>M</b>  | 1704mm / 6600lm / 48.6W  | 770.25.01.RTG.2 | € 512.00 |
| <b>L</b>  | 2267mm / 8800lm / 64.8W  | 770.25.01.RTG.3 | € 751.00 |
| <b>XL</b> | 3392mm / 13200lm / 97.2W | 770.25.01.RTG.4 | € 940.00 |

### Matt White Texture - Surface Mounted

|           |                          |                 |          |
|-----------|--------------------------|-----------------|----------|
| <b>S</b>  | 1153mm / 4400lm / 32.4W  | 770.25.01.RTG.5 | € 418.00 |
| <b>M</b>  | 1716mm / 6600lm / 48.6W  | 770.25.01.RTG.6 | € 512.00 |
| <b>L</b>  | 2287mm / 8800lm / 64.8W  | 770.25.01.RTG.7 | € 751.00 |
| <b>XL</b> | 3412mm / 13200lm / 97.2W | 770.25.01.RTG.8 | € 940.00 |

### Aluminium Anodised - Suspended

|           |                          |                 |          |
|-----------|--------------------------|-----------------|----------|
| <b>S</b>  | 1141mm / 4400lm / 32.4W  | 770.25.10.RTG.1 | € 416.00 |
| <b>M</b>  | 1704mm / 6600lm / 48.6W  | 770.25.10.RTG.2 | € 511.00 |
| <b>L</b>  | 2267mm / 8800lm / 64.8W  | 770.25.10.RTG.3 | € 748.00 |
| <b>XL</b> | 3392mm / 13200lm / 97.2W | 770.25.10.RTG.4 | € 937.00 |

### Aluminium Anodised - Surface Mounted

|           |                          |                 |          |
|-----------|--------------------------|-----------------|----------|
| <b>S</b>  | 1153mm / 4400lm / 32.4W  | 770.25.10.RTG.5 | € 416.00 |
| <b>M</b>  | 1716mm / 6600lm / 48.6W  | 770.25.10.RTG.6 | € 511.00 |
| <b>L</b>  | 2287mm / 8800lm / 64.8W  | 770.25.10.RTG.7 | € 748.00 |
| <b>XL</b> | 3412mm / 13200lm / 97.2W | 770.25.10.RTG.8 | € 937.00 |

## LEDLiner65

DALI dimmable

### Matt White Texture - Suspended

|           |                          |                 |          |
|-----------|--------------------------|-----------------|----------|
| <b>S</b>  | 1141mm / 4400lm / 32.4W  | 770.26.01.RTG.1 | € 423.00 |
| <b>M</b>  | 1704mm / 6600lm / 48.6W  | 770.26.01.RTG.2 | € 517.00 |
| <b>L</b>  | 2267mm / 8800lm / 64.8W  | 770.26.01.RTG.3 | € 761.00 |
| <b>XL</b> | 3392mm / 13200lm / 97.2W | 770.26.01.RTG.4 | € 950.00 |

### Matt White Texture - Surface Mounted

|           |                          |                 |          |
|-----------|--------------------------|-----------------|----------|
| <b>S</b>  | 1153mm / 4400lm / 32.4W  | 770.26.01.RTG.5 | € 423.00 |
| <b>M</b>  | 1716mm / 6600lm / 48.6W  | 770.26.01.RTG.6 | € 517.00 |
| <b>L</b>  | 2287mm / 8800lm / 64.8W  | 770.26.01.RTG.7 | € 761.00 |
| <b>XL</b> | 3412mm / 13200lm / 97.2W | 770.26.01.RTG.8 | € 950.00 |

### Aluminium Anodised - Suspended

|           |                          |                 |          |
|-----------|--------------------------|-----------------|----------|
| <b>S</b>  | 1141mm / 4400lm / 32.4W  | 770.26.10.RTG.1 | € 421.00 |
| <b>M</b>  | 1704mm / 6600lm / 48.6W  | 770.26.10.RTG.2 | € 516.00 |
| <b>L</b>  | 2267mm / 8800lm / 64.8W  | 770.26.10.RTG.3 | € 758.00 |
| <b>XL</b> | 3392mm / 13200lm / 97.2W | 770.26.10.RTG.4 | € 947.00 |

### Aluminium Anodised - Surface Mounted

|           |                          |                 |          |
|-----------|--------------------------|-----------------|----------|
| <b>S</b>  | 1153mm / 4400lm / 32.4W  | 770.26.10.RTG.5 | € 421.00 |
| <b>M</b>  | 1716mm / 6600lm / 48.6W  | 770.26.10.RTG.6 | € 516.00 |
| <b>L</b>  | 2287mm / 8800lm / 64.8W  | 770.26.10.RTG.7 | € 758.00 |
| <b>XL</b> | 3412mm / 13200lm / 97.2W | 770.26.10.RTG.8 | € 947.00 |



# LEDLiner140

## Asymmetric Down

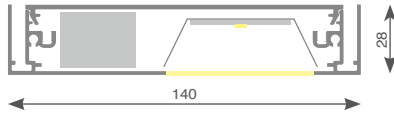

### LEDLiner140

A flat and sleek rectangular aluminium profile 140 x 28mm. Using Philips LED's, **LEDLiner140** offers the latest and best performing LED technology. **LEDLiner140** can be used as direct lighting or indirect lighting. Direct lighting is positioned asymmetric giving an extra dimension to its unique design. LED accent lighting, daylight sensors, emergency lighting, multiple supplies, any RAL color, etc... can be implemented.

Probably one of the purest designed office LED solutions.

|          |   |
|----------|---|
| Type     | Suspended Profile<br>Surface Mounted Profile (option) |
| Material | Aluminium   |

### Philips Fortimo LED-Line HV / LV

|                   |            |
|-------------------|------------|
| Efficiency        | 135lm/W    |
| CRI               | Ra80       |
| Color Temperature | 3000K      |
| Lifetime          | 50.000 Hrs |

5 Years **Philips** Warranty

### Optional ceiling connector:



### Options

|                              |              |          |
|------------------------------|--------------|----------|
| Actilume Daylight Sensor     | 659.00.00    | € 213.00 |
| Emergency Lighting 1Hr       | 659.00.LED-1 | € 275.00 |
| Emergency Lighting 3Hrs      | 659.00.LED-3 | € 325.00 |
| Ceiling connector (set of 2) | 678.00.00    | € 50.00  |

### On Request

|   |           |         |
|---|-----------|---------|
| Custom made lengths & shapes (see profiles catalogue) |           |         |
| Other RAL colors                                      |           |         |
| Wiring other than standard (see p.165)                |           |         |
| Ceiling connector (set of 2)                          | 678.00.00 | € 50.00 |

### Included

|                                  |
|----------------------------------|
| Profile                          |
| End Caps                         |
| LED Modules                      |
| PC Cover down matt               |
| Standard "Y" suspension (2100mm) |
| Mounting connecting box          |
| Power supply cable (2100mm)      |

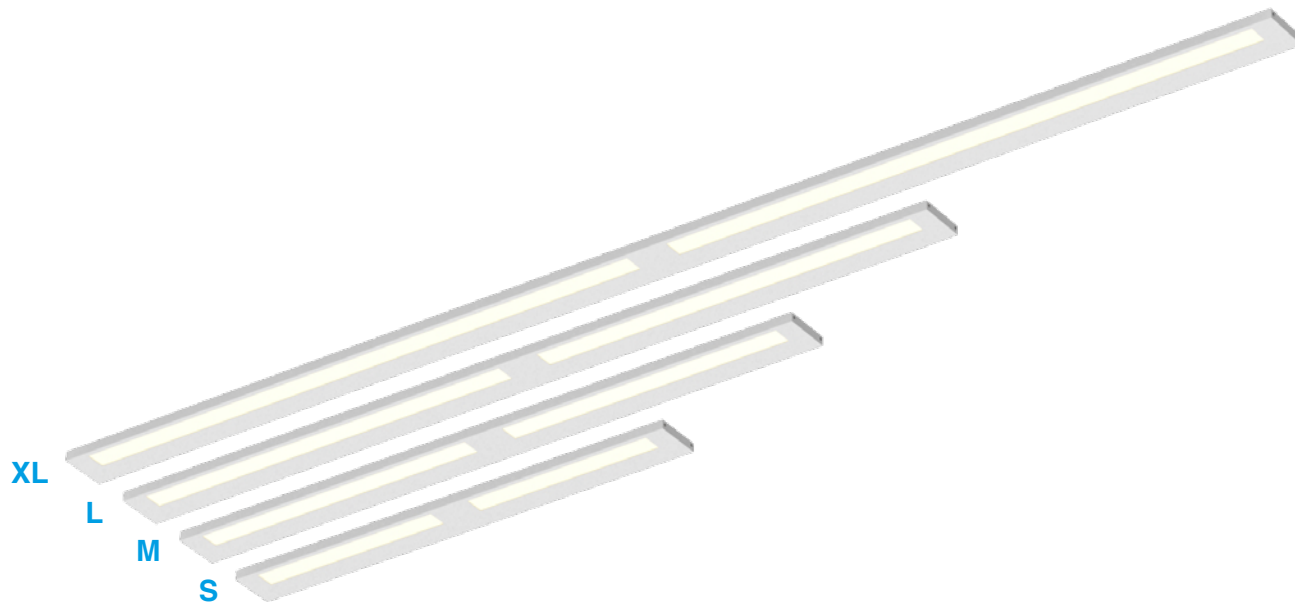

## LEDLiner140 Asym. Down

Non dimmable (suspended)

### Matt White Texture

|    |                          |                 |          |
|----|--------------------------|-----------------|----------|
| S  | 1370mm / 4400lm / 32.4W  | 780.24.01.RTG.5 | € 440.00 |
| L  | 2490mm / 8800lm / 64.8W  | 780.24.01.RTG.7 | € 747.00 |
| XL | 3620mm / 13200lm / 97.2W | 780.24.01.RTG.8 | € 830.00 |

### Aluminium Anodised

|    |                          |                 |          |
|----|--------------------------|-----------------|----------|
| S  | 1370mm / 4400lm / 32.4W  | 780.24.10.RTG.5 | € 425.00 |
| L  | 2490mm / 8800lm / 64.8W  | 780.24.10.RTG.7 | € 715.00 |
| XL | 3620mm / 13200lm / 97.2W | 780.24.10.RTG.8 | € 780.00 |

# LEDLiner190

## Symmetric Down

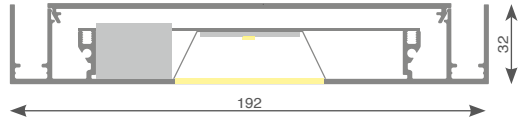

### LEDLiner190

Based on a flat, sleek aluminium extruded profile 192 x 32mm, **LEDLiner190** offers the latest and best performing LED lighting technology using Philips LED-Lines. These LED Lines can be used as direct lighting, indirect lighting or combined direct/indirect lighting. Direct lighting can either be positioned symmetric or asymmetric giving an extra dimension to **LEDLiner190**'s unique design.

Accent lighting by FlatLED, a very thin gimble/cardanic recessed downlight. Probably one of the purest designed office LED solutions.

|          |   |
|----------|---|
| Type     | Suspended Profile<br>Surface Mounted Profile (option) |
| Material | Aluminium   |

### Philips Fortimo LED-Line HV

|                   |            |
|-------------------|------------|
| Efficiency        | 135lm/W    |
| CRI               | Ra80       |
| Color Temperature | 3000K      |
| Lifetime          | 50.000 Hrs |

5 Years **Philips** Warranty

#### Optional wall bracket:



#### Optional ceiling connector:



### Options

|                              |              |          |
|------------------------------|--------------|----------|
| Actilume Daylight Sensor     | 659.00.00    | € 213.00 |
| Emergency Lighting 1Hr       | 659.00.LED-1 | € 275.00 |
| Emergency Lighting 3Hrs      | 659.00.LED-3 | € 325.00 |
| Ceiling connector (set of 2) | 678.00.00    | € 50.00  |
| Wall Bracket (1pc)           | 677.00.00    | € 60.00  |

### On Request

Custom made lengths & shapes (see profiles catalogue)  
Other RAL colors  
Wiring other than standard (see p.165)

### Included

Profile  
End Caps  
LED Modules  
PC Cover down matt  
Standard "Y" suspension (2100mm)  
Mounting connecting box  
Power supply cable (2100mm)

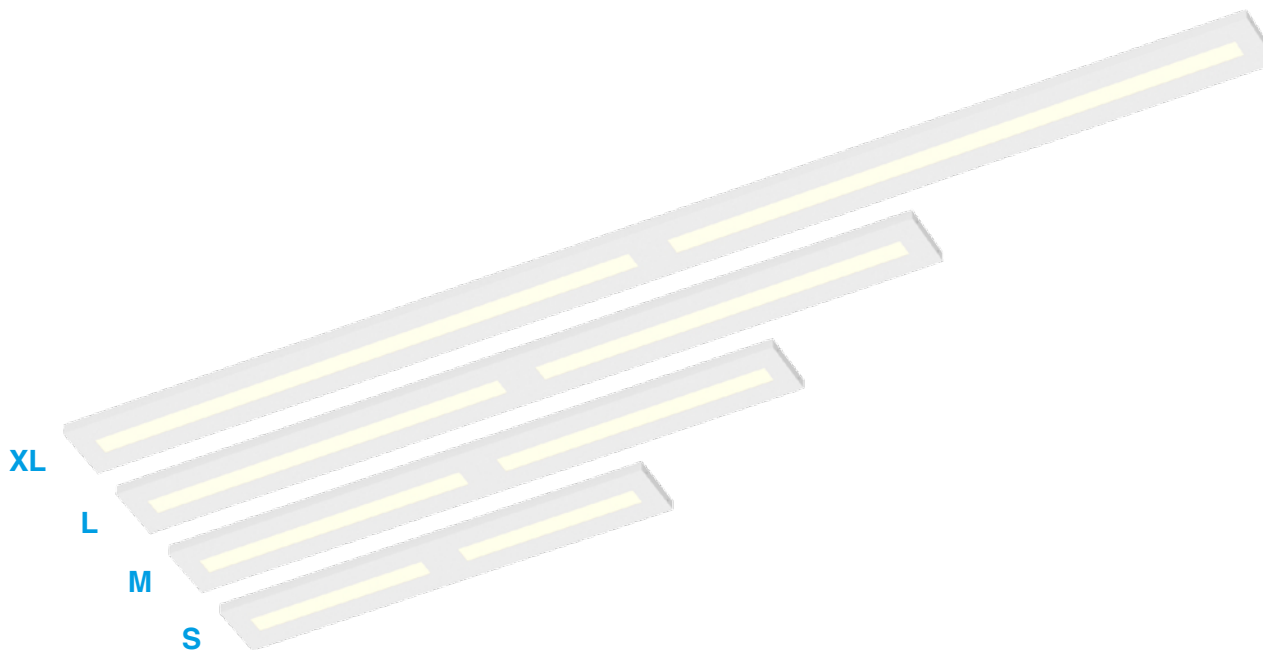

### LEDLiner190 Sym. Down

Non dimmable (suspended)

#### Matt White Texture

|           |                          |                 |           |
|-----------|--------------------------|-----------------|-----------|
| <b>S</b>  | 1370mm / 4400lm / 32.4W  | 660.24.01.RTG.1 | € 477.00  |
| <b>M</b>  | 1930mm / 6600lm / 48.6W  | 660.24.01.RTG.2 | € 638.00  |
| <b>L</b>  | 2500mm / 8800lm / 64.8W  | 660.24.01.RTG.3 | € 888.00  |
| <b>XL</b> | 3620mm / 13200lm / 97.2W | 660.24.01.RTG.4 | € 1211.00 |

#### Aluminium anodised

|           |                          |                 |           |
|-----------|--------------------------|-----------------|-----------|
| <b>S</b>  | 1370mm / 4400lm / 32.4W  | 660.24.10.RTG.1 | € 440.00  |
| <b>M</b>  | 1930mm / 6600lm / 48.6W  | 660.24.10.RTG.2 | € 586.00  |
| <b>L</b>  | 2500mm / 8800lm / 64.8W  | 660.24.10.RTG.3 | € 815.00  |
| <b>XL</b> | 3620mm / 13200lm / 97.2W | 660.24.10.RTG.4 | € 1107.00 |

### LEDLiner190 Sym. Down

1-10V dimmable (suspended)

#### Matt White Texture

|           |                          |                 |           |
|-----------|--------------------------|-----------------|-----------|
| <b>S</b>  | 1370mm / 4400lm / 32.4W  | 660.25.01.RTG.1 | € 560.00  |
| <b>M</b>  | 1930mm / 6600lm / 48.6W  | 660.25.01.RTG.2 | € 723.00  |
| <b>L</b>  | 2500mm / 8800lm / 64.8W  | 660.25.01.RTG.3 | € 1037.00 |
| <b>XL</b> | 3620mm / 13200lm / 97.2W | 660.25.01.RTG.4 | € 1364.00 |

#### Aluminium anodised

|           |                          |                 |           |
|-----------|--------------------------|-----------------|-----------|
| <b>S</b>  | 1370mm / 4400lm / 32.4W  | 660.25.10.RTG.1 | € 524.00  |
| <b>M</b>  | 1930mm / 6600lm / 48.6W  | 660.25.10.RTG.2 | € 672.00  |
| <b>L</b>  | 2500mm / 8800lm / 64.8W  | 660.25.10.RTG.3 | € 964.00  |
| <b>XL</b> | 3620mm / 13200lm / 97.2W | 660.25.10.RTG.4 | € 1260.00 |

### LEDLiner190 Sym. Down

DALI dimmable (suspended)

#### Matt White Texture

|           |                          |                 |           |
|-----------|--------------------------|-----------------|-----------|
| <b>S</b>  | 1370mm / 4400lm / 32.4W  | 660.26.01.RTG.1 | € 565.00  |
| <b>M</b>  | 1930mm / 6600lm / 48.6W  | 660.26.01.RTG.2 | € 728.00  |
| <b>L</b>  | 2500mm / 8800lm / 64.8W  | 660.26.01.RTG.3 | € 1047.00 |
| <b>XL</b> | 3620mm / 13200lm / 97.2W | 660.26.01.RTG.4 | € 1374.00 |

#### Aluminium anodised

|           |                          |                 |           |
|-----------|--------------------------|-----------------|-----------|
| <b>S</b>  | 1370mm / 4400lm / 32.4W  | 660.26.10.RTG.1 | € 529.00  |
| <b>M</b>  | 1930mm / 6600lm / 48.6W  | 660.26.10.RTG.2 | € 677.00  |
| <b>L</b>  | 2050mm / 8800lm / 64.8W  | 660.26.10.RTG.3 | € 974.00  |
| <b>XL</b> | 3620mm / 13200lm / 97.2W | 660.26.10.RTG.4 | € 1270.00 |

# LEDLiner190

## Symmetric Down + FlatLED

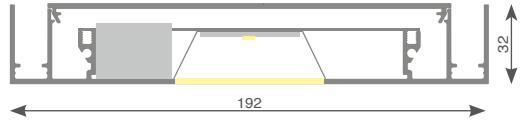

### LEDLiner190

Based on a flat, sleek aluminium extruded profile 192 x 32mm, **LEDLiner190** offers the latest and best performing LED lighting technology using Philips LED-Lines. These LED Lines can be used as direct lighting, indirect lighting or combined direct/indirect lighting. Direct lighting can either be positioned symmetric or asymmetric giving an extra dimension to **LEDLiner190**'s unique design.

Accent lighting by FlatLED, a very thin gimble/cardanic recessed downlight. Probably one of the purest designed office LED solutions.

|          |   |
|----------|---|
| Type     | Suspended Profile<br>Surface Mounted Profile (option) |
| Material | Aluminium   |

### Philips Fortimo LED-Line HV

|                   |            |
|-------------------|------------|
| Efficiency        | 135lm/W    |
| CRI               | Ra80       |
| Color Temperature | 3000K      |
| Lifetime          | 50.000 Hrs |

5 Years **Philips** Warranty

#### Optional wall bracket:



#### Optional ceiling connector:



### Options

|                              |              |          |
|------------------------------|--------------|----------|
| Actilume Daylight Sensor     | 659.00.00    | € 213.00 |
| Emergency Lighting 1Hr       | 659.00.LED-1 | € 275.00 |
| Emergency Lighting 3Hrs      | 659.00.LED-3 | € 325.00 |
| Ceiling connector (set of 2) | 678.00.00    | € 50.00  |
| Wall Bracket (1pc)           | 677.00.00    | € 60.00  |

### On Request

Custom made lengths & shapes (see profiles catalogue)  
Other RAL colors  
Wiring other than standard (see p.165)

### Included

Profile  
End Caps  
LED Modules  
LED Downlight Modules  
PC Cover down matt  
Standard "Y" suspension (2100mm)  
Mounting connecting box  
Power supply cable (2100mm)

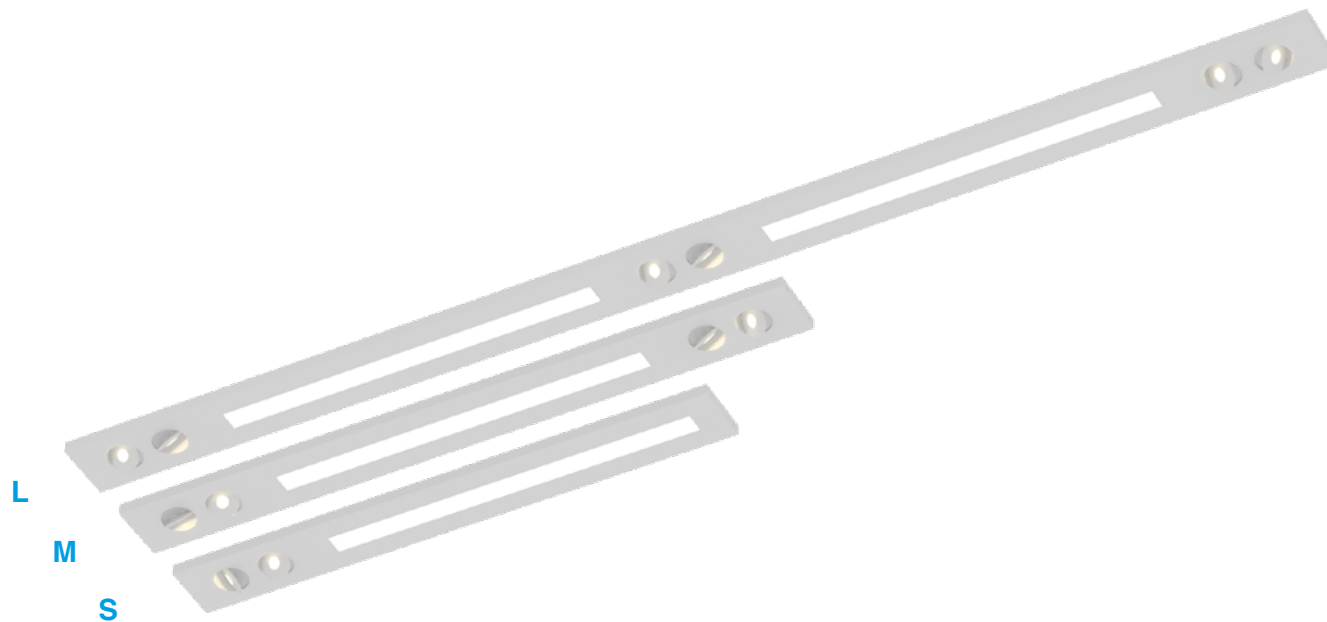

### LEDLiner190 Sym. Down + FlatLED

Non dimmable (suspended)

|   |                  |           |
|---|------------------|-----------|
| <b>S 1670mm / 4400lm / 32.4W + 2x FlatLED</b> |                  |           |
| Matt White Texture                            | 660.24.01.RTG.16 | € 907.00  |
| Aluminium anodised                            | 660.24.10.RTG.16 | € 859.00  |
| <b>M 2040mm / 4400lm / 48.6W + 4x FlatLED</b> |                  |           |
| Matt White Texture                            | 660.24.01.RTG.17 | € 1327.00 |
| Aluminium anodised                            | 660.24.10.RTG.17 | € 1269.00 |
| <b>L 3680mm / 8800lm / 64.8W + 6x FlatLED</b> |                  |           |
| Matt White Texture                            | 660.24.01.RTG.18 | € 2174.00 |
| Aluminium anodised                            | 660.24.10.RTG.18 | € 2067.00 |

### LEDLiner190 Sym. Down + FlatLED

1-10V dimmable (only LEDlines) (suspended)

|   |                  |           |
|---|------------------|-----------|
| <b>S 1670mm / 4400lm / 32.4W + 2x FlatLED</b> |                  |           |
| Matt White Texture                            | 660.25.01.RTG.16 | € 1039.00 |
| Aluminium anodised                            | 660.25.10.RTG.16 | € 990.00  |
| <b>M 2040mm / 4400lm / 48.6W + 4x FlatLED</b> |                  |           |
| Matt White Texture                            | 660.25.01.RTG.17 | € 1506.00 |
| Aluminium anodised                            | 660.25.10.RTG.17 | € 1449.00 |
| <b>L 3680mm / 8800lm / 64.8W + 6x FlatLED</b> |                  |           |
| Matt White Texture                            | 660.25.01.RTG.18 | € 2468.00 |
| Aluminium anodised                            | 660.25.10.RTG.18 | € 2360.00 |

### LEDLiner190 Sym. Down + FlatLED

DALI dimmable (only LEDlines) (suspended)

|   |                  |           |
|---|------------------|-----------|
| <b>S 1670mm / 4400lm / 32.4W + 2x FlatLED</b> |                  |           |
| Matt White Texture                            | 660.26.01.RTG.16 | € 1069.00 |
| Aluminium anodised                            | 660.26.10.RTG.16 | € 1020.00 |
| <b>M 2040mm / 4400lm / 48.6W + 4x FlatLED</b> |                  |           |
| Matt White Texture                            | 660.26.01.RTG.17 | € 1561.00 |
| Aluminium anodised                            | 660.26.10.RTG.17 | € 1504.00 |
| <b>L 3680mm / 8800lm / 64.8W + 6x FlatLED</b> |                  |           |
| Matt White Texture                            | 660.26.01.RTG.18 | € 2553.00 |
| Aluminium anodised                            | 660.26.10.RTG.18 | € 2445.00 |



# Amazon LEDLine

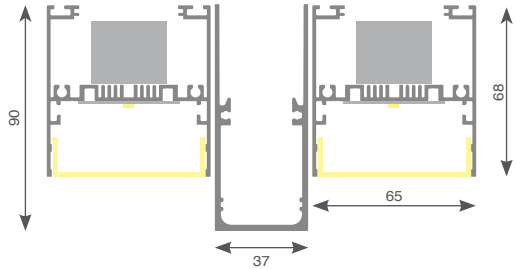

## Amazon

Suspended aluminium extruded profile. The base profile 37x90mm is used as a carrier of different LED modules. Those modules are all independent, drivers included. After installation, Amazon offers the possibility of adding or re-locating modules.

These modules can be used as direct lighting or indirect lighting.

**Amazon** offers the latest and best performing lighting technology using Philips LED components.

LED accent lighting modules are mounted as cardanic/gimble modules sideways to the profile. This design makes Amazon unique and gives the system an extra dimension.

|          |                   |
|----------|-------------------|
| Type     | Suspended Profile |
| Material | Aluminium         |

## Philips Fortimo LED-Line HV

|                   |            |
|-------------------|------------|
| Efficiency        | 135lm/W    |
| CRI               | Ra80       |
| Color Temperature | 3000K      |
| Lifetime          | 50.000 Hrs |

5 Years **Philips** Warranty



## Options

|                          |              |          |
|--------------------------|--------------|----------|
| Actilume Daylight Sensor | 659.00.00    | € 213.00 |
| Emergency Lighting 1Hr   | 659.00.LED-1 | € 275.00 |
| Emergency Lighting 3Hrs  | 659.00.LED-3 | € 325.00 |

## On Request

Custom made lengths & shapes (see profiles catalogue)  
Other RAL colors  
Wiring other than standard (see p.165)

## Included

Profile  
End Caps  
LED Modules  
PC Covers down matt  
Suspensions (2100mm)  
Mounting connecting box  
Power supply cable (2100mm)



### Amazon

Non dimmable

|                      |                  |           |  |
|----------------------|------------------|-----------|--|
| <b>S 1260mm</b>      |                  |           |  |
| 1x LEDLine Module LV | 855.24.xx.RTG.10 | € 650.00  |  |
| <b>M 1550mm</b>      |                  |           |  |
| 1x LEDLine Module HV | 855.24.xx.RTG.11 | € 706.00  |  |
| <b>L 2270mm</b>      |                  |           |  |
| 2x LEDLine Module LV | 855.24.xx.RTG.12 | € 1183.00 |  |
| <b>XL 2880mm</b>     |                  |           |  |
| 2x LEDLine Module HV | 855.24.xx.RTG.13 | € 1326.00 |  |

### Amazon

1-10V dimmable

|                      |                  |           |  |
|----------------------|------------------|-----------|--|
| <b>S 1260mm</b>      |                  |           |  |
| 1x LEDLine Module LV | 855.25.xx.RTG.10 | € 832.00  |  |
| <b>M 1550mm</b>      |                  |           |  |
| 1x LEDLine Module HV | 855.25.xx.RTG.11 | € 866.00  |  |
| <b>L 2270mm</b>      |                  |           |  |
| 2x LEDLine Module LV | 855.25.xx.RTG.12 | € 1531.00 |  |
| <b>XL 2880mm</b>     |                  |           |  |
| 2x LEDLine Module HV | 855.25.xx.RTG.13 | € 1614.00 |  |

1 LEDLine Module LV = Ra80 - 3000K - 48.6W - 6600lm (double sided)  
 1 LEDLine Module HV = Ra80 - 3000K - 64.8W - 8800lm (double sided)

### Amazon

DALI dimmable

|                      |                  |           |  |
|----------------------|------------------|-----------|--|
| <b>S 1260mm</b>      |                  |           |  |
| 1x LEDLine Module LV | 855.26.xx.RTG.10 | € 848.00  |  |
| <b>M 1550mm</b>      |                  |           |  |
| 1x LEDLine Module HV | 855.26.xx.RTG.11 | € 868.00  |  |
| <b>L 2270mm</b>      |                  |           |  |
| 2x LEDLine Module LV | 855.26.xx.RTG.12 | € 1561.00 |  |
| <b>XL 2880mm</b>     |                  |           |  |
| 2x LEDLine Module HV | 855.26.xx.RTG.13 | € 1634.00 |  |

Available colors: 000.00.xx.RTG.0

**01:** Matt White Texture

**03:** Matt Black Texture

**05:** Matt White Texture (profile) + Matt Black Texture (module)

Other RAL colors on request!!

# Amazon Titan

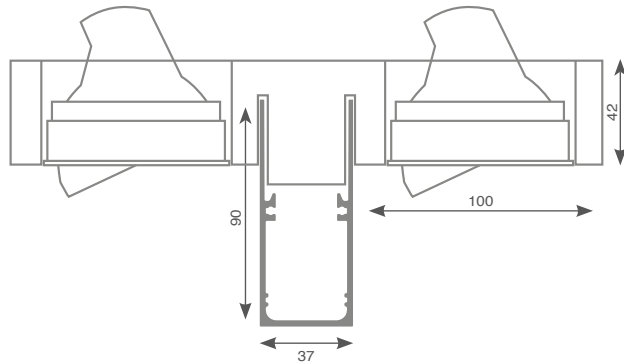

## Amazon

Suspended aluminium extruded profile. The base profile 37x90mm is used as a carrier of different LED modules. Those modules are all independent, drivers included. After installation, Amazon offers the possibility of adding or re-locating modules.

These modules can be used as direct lighting or indirect lighting.

**Amazon** offers the latest and best performing lighting technology using Philips LED components.

LED accent lighting modules are mounted as cardanic/gimble modules sideways to the profile. This design makes Amazon unique and gives the system an extra dimension.

|          |                   |
|----------|-------------------|
| Type     | Suspended Profile |
| Material | Aluminium         |

## Philips Fortimo LED-Line HV

|                   |            |
|-------------------|------------|
| Efficiency        | 135lm/W    |
| CRI               | Ra80       |
| Color Temperature | 3000K      |
| Lifetime          | 50.000 Hrs |

5 Years **Philips** Warranty



## Options

Only for LEDline modules on RTG L and RTG XL

|                          |              |          |
|--------------------------|--------------|----------|
| Actilume Daylight Sensor | 659.00.00    | € 213.00 |
| Emergency Lighting 1Hr   | 659.00.LED-1 | € 275.00 |
| Emergency Lighting 3Hrs  | 659.00.LED-3 | € 325.00 |

## On Request

Custom made lengths & shapes (see profiles catalogue)  
Other RAL colors  
Wiring other than standard (see p.165)

## Included

Profile  
End Caps  
LED Modules  
Downlight Modules  
PC Cover down matt  
Standard "Y" suspension (2100mm)  
Mounting connecting box  
Power supply cable (2100mm)

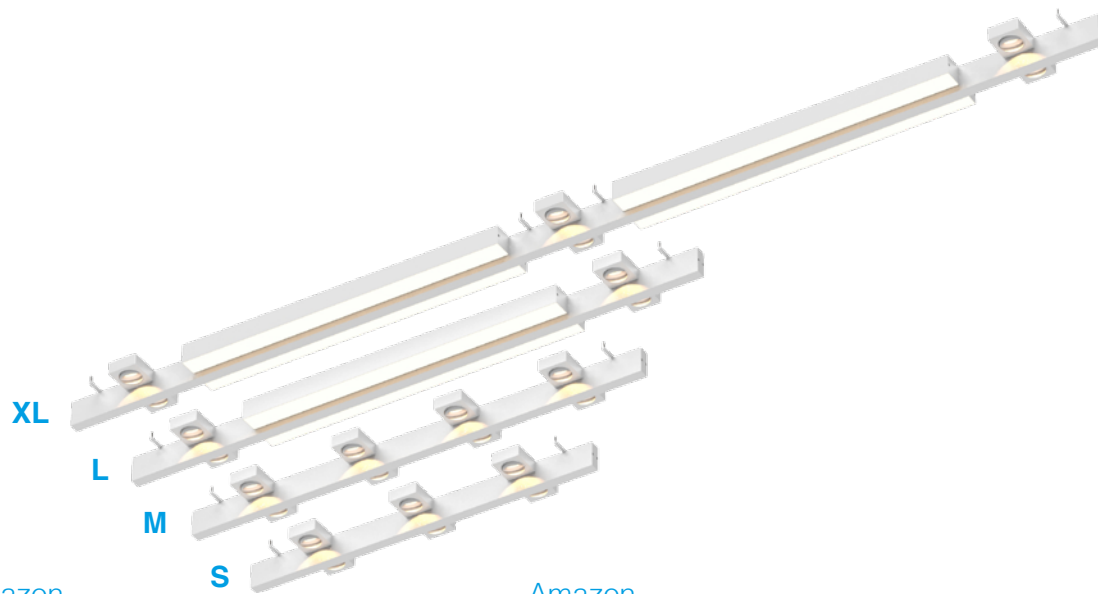

**Amazon**  
Non dimmable

|  |                  |           |  |
|--|------------------|-----------|--|
| <b>S 1260mm</b>                        |                  |           |  |
| 3x Titan module                        | 855.24.xx.RTG.14 | € 1564.00 |  |
| <b>M 1550mm</b>                        |                  |           |  |
| 4x Titan module                        | 855.24.xx.RTG.15 | € 2033.00 |  |
| <b>L 2270mm</b>                        |                  |           |  |
| 2x Titan module + 1x LEDLine module HV | 855.24.xx.RTG.16 | € 1631.00 |  |
| <b>XL 2880mm</b>                       |                  |           |  |
| 3x Titan module + 2x LEDLine module HV | 855.24.xx.RTG.17 | € 2732.00 |  |

**Amazon**  
1-10V dimmable (only LEDline modules)

|  |                  |           |  |
|--|------------------|-----------|--|
| -                                      |                  |           |  |
| -                                      |                  |           |  |
| <b>L 2270mm</b>                        |                  |           |  |
| 2x Titan module + 1x LEDLine module HV | 855.25.xx.RTG.16 | € 1785.00 |  |
| <b>XL 2880mm</b>                       |                  |           |  |
| 3x Titan module + 2x LEDLine module HV | 855.25.xx.RTG.17 | € 3020.00 |  |

**Amazon**  
DALI dimmable (only LEDline modules)

|  |                  |           |  |
|--|------------------|-----------|--|
| -                                      |                  |           |  |
| -                                      |                  |           |  |
| <b>L 2270mm</b>                        |                  |           |  |
| 2x Titan module + 1x LEDLine module HV | 855.26.xx.RTG.16 | € 1795.00 |  |
| <b>XL 2880mm</b>                       |                  |           |  |
| 3x Titan module + 2x LEDLine module HV | 855.26.xx.RTG.17 | € 3040.00 |  |

1 Titan Module = Ra80 - 3000K - 18.6W - 2x975lm (double sided)  
1 LEDLine Module HV = Ra80 - 3000K - 64.8W - 8800lm (double sided)

Available colors: 000.00.xx.RTG.0

- 01:** Matt White Texture └ color
  - 03:** Matt Black Texture
  - 05:** Matt White Texture (profile) + Matt Black Texture (module)
- Other RAL colors on request!!

# LEDLiner20

Small aluminium profile. Standard in anodised or white.  
 Other RAL colors on request.  
 Standard profile-length 3000mm. Standard LED strip lengths 5000mm.  
 Easy to install thanks to 3M adhesive at the back.  
 We can produce custom made lengths/angles.  
 Ideal to use for indirect lighting, kitchen cabinets, staircases, corridors, etc..

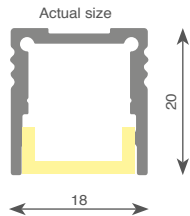

Type Surface mounted

**Profile**  
 Available in 2 colors: Alu anodised and matt white texture  
 Mounting clips to be ordered separately  
**LEDStrip**  
 Driver / Dimmer / Controller to be ordered separately  
 Every 3 LEDs cuttable  
 Operating temperatur -25°C to 60°C  
 Color Temperature 3000K / RGB  
 Lifetime 50.000 - 80.000 Hrs  
 LED Quantity 60pcs/m



| LED-STRIP       |           | Light source | Voltage (DC) | Power | Roll Length | Colour temp. | IP | Lifetime         |
|-----------------|-----------|--------------|--------------|-------|-------------|--------------|----|------------------|
|                 |           |              | V            | W/m   | mm          | K            |    | Hrs              |
| LED STRIP 3000K | 602.25.01 | LED          | 12           | 14,4  | 5000        | 3000         | 20 | 50.000 to 80.000 |
|                 | 602.25.02 | LED          | 12           | 14,4  | 5000        | 3000         | 65 | 50.000 to 80.000 |
| LED STRIP RGB   | 602.25.03 | LED          | 12           | 14,4  | 5000        | RGB          | 20 | 50.000 to 80.000 |



**PROFILE incl. clear PC**

PRICE PER LENGTH OF 3000mm  
ALU ANODISED 600.00.10-C € 89.00



PRICE /3m

**PROFILE incl. Frosted PC**

PRICE PER LENGTH OF 3000mm  
ALU ANODISED 600.00.10-F € 96.00



PRICE /3m

**MOUNTING CLIP**

SET OF 2 601.00.10 € 4.00



**CUSTOMISATION**

ON REQUEST



**LED-STRIP 12mm IP20 3000K**

5m roll - 14,1W 602.25.01 € 67.00



IP20

**LED-STRIP 12mm IP65 3000K**

5m roll - 14,1W 602.25.02 € 75.00



IP65

**LED-STRIP 12mm IP20 RGB**

5m roll - 14,1W RGB 602.25.03 € 67.00



IP20

**DIMMER CONTROLLER**

L x B x H: 90mm x 30mm x 60mm  
DIMMER CONTROLLER 602.00.08 €10.00



**DRIVER 30W**

L x B x H: 86mm x 58mm x 34mm  
DRIVER 30W 602.00.05 € 28.00



**DRIVER 60W**

L x B x H: 162mm x 98mm x 38mm  
DRIVER 60W 602.00.06 € 47.00

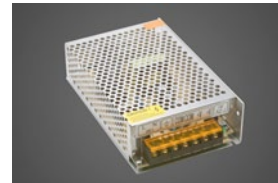

**DRIVER 100W**

L x B x H: 162mm x 98mm x 38mm  
DRIVER 100W 602.00.09 € 76.00

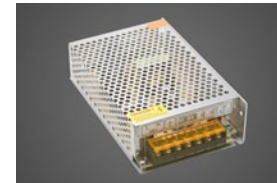

**CONTROLLER RGB**

L x B x H: 75mm x 35mm x 22mm  
CONTROLLER RGB + REMOTE 602.00.07 €10.00







# Technical

|                                   |     |
|-----------------------------------|-----|
| LED Advantages.....               | 158 |
| Titan variations .....            | 159 |
| Bridgelux Vero 10 LED .....       | 160 |
| Titan LED Replacement .....       | 161 |
| Fortimo LED .....                 | 162 |
| Fortimo Crisp White.....          | 163 |
| Fortimo Food/Meat.....            | 163 |
| Fortimo Cooling .....             | 163 |
| Custom made profiles.....         | 164 |
| Fortimo LEDLine.....              | 165 |
| Fortimo LEDstrip.....             | 165 |
| LEDLine vs. T5 .....              | 166 |
| Wiring .....                      | 168 |
| Xitanium + accessories .....      | 167 |
| Concrete build-in solutions ..... | 168 |
| Article number index.....         | 170 |
| Doxis.....                        | 172 |
| General Terms.....                | 173 |



# LED advantages

## Benefits

### 1. Long Life

Long life time stands out as the number one benefit of LED lights. LED bulbs and diodes have an outstanding operational life time expectation of up to 100.000 hours. This is 11 years of continuous operation, or 22 years of 50% operation. If you leave on the LED fixture for 8h per day it would take around 20 years before you'd have to replace the LED bulb.

LED's are different to standard lighting: They don't really burn out and stop working like a standard light, moreover the lighting diodes emit lower output levels over a very long period of time and become less bright.

### 2. Energy Efficiency

Today's most efficient way of illumination and lighting, with an estimated energy efficiency of 80%-90% when compared to traditional lighting and conventional light bulbs. This means that about 80% of the electrical energy is converted to light, while a ca. 20% is lost and converted into other forms of energy such as heat.

With traditional incandescent light bulbs who operate at 20% energy efficiency only, a 80% of the electricity is lost as heat.

### 3. Ecologically Friendly

LED lights are free of toxic chemicals. Most conventional fluorescent lighting bulbs contain a multitude of materials like e.g mercury that are dangerous for the environment.

LED lights contain no toxic materials and are 100% recyclable, and will help you to reduce your carbon footprint by up to a third. The long operational life time span mentioned above means also that one LED light bulb can save material and production of 25 incandescent light bulbs. A big step towards a greener future!

### 4. Durable Quality

LEDs are extremely durable and built with sturdy components that are highly rugged and can withstand even the roughest conditions.

### 5. Zero UV Emissions

LED illumination produces little infrared light and close to no UV emissions.

Because of this, LED lighting is highly suitable not only for goods and materials that are sensitive to heat due to the benefit of little radiated heat emission, but also for illumination of UV sensitive objects or materials such as in museums, art galleries, archeological sites etc.

### 6. Design Flexibility

LEDs can be combined in any shape to produce highly efficient illumination. Individual LEDs can be dimmed, resulting in a dynamic control of light, color and distribution. Well-designed LED illumination systems can achieve fantastic lighting effects, not only for the eye but also for the mood and the mind:

### 7. Light Dispersement

LED is designed to focus its light and can be directed to a specific location without the use of an external reflector, achieving a higher application efficiency than conventional lighting. Well-designed LED illumination systems are able to deliver light more efficiently to the desired location.

### 8. Instant Lighting & Frequent Switching

LED lights brighten up immediately when powered on.

Also, LED lights can be switched off and on frequently and without affecting the LED's lifetime or light emission. In contrast, traditional lighting may take several seconds to reach full brightness, and frequent on/off switching does drastically reduce operational life expectancy.

9. Excellent color rendering. LED's do not wash out colors like other light sources such as fluorescents, making them perfect for displays and retail applications.

10. Controllable: LEDs can be controlled for brightness and color.

# Titan Variations

Cone ◀ ▶

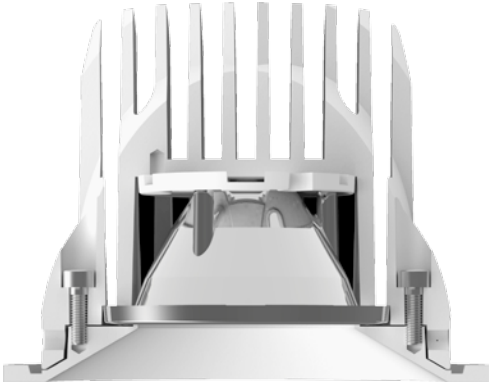

Organic ▶ ◀

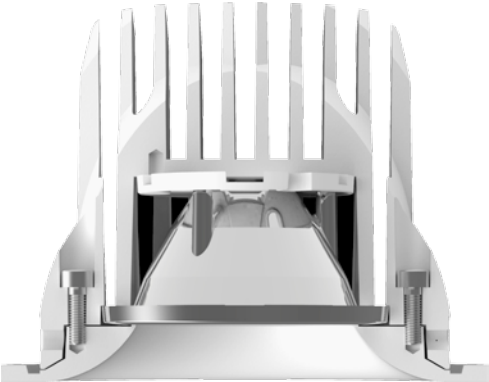

Anti-glare ■ ■

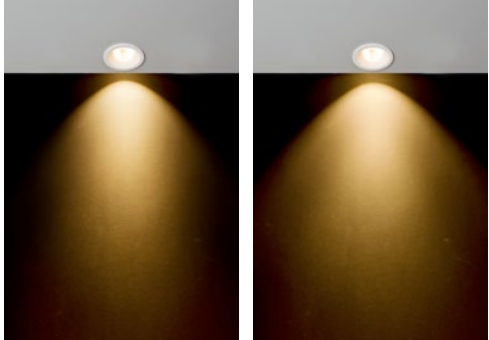
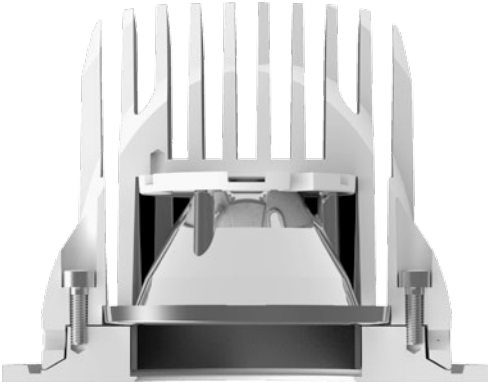

28° Reflector

40° Reflector

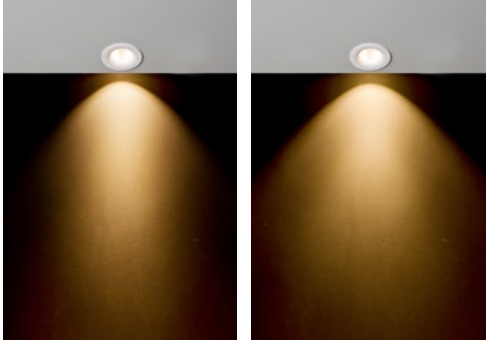

28° Reflector

40° Reflector

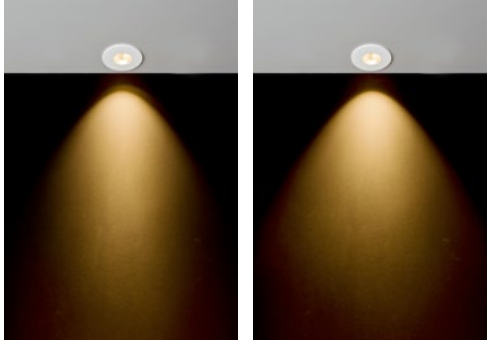

28° Reflector

40° Reflector

# Bridgelux Vera 10 LED info + possibilities

The Bridgelux Vera next generation LED packaged array technology offers new advancements in design flexibility, ease of use, and energy efficiency today while also defining a platform for future opportunities to integrate smart sensors and wireless communication technology for smart building control systems and other innovative applications. The Vera Series has industry leading performance and is available in configurations with color temperatures from 2700K to 5000K and a wide variety of CRI options.

## Features

- Market leading efficacy,
- Broad range of CCT options from 2700K to 5000K
- CRI options include; minimum 70, 80, 90 for standard and 97 typical for Decor products
- 2 and 3 SDCM color control for 2700K-4000K CCT
- Reliable operation at up to 2X rated drive current
- Radial die pattern and improved lumen density
- 5-Year limited warranty

## Benefits

- Broad application coverage for interior and exterior lighting
- Flexibility to respond to application driven lighting design requirements
- High quality true color reproduction
- Uniform consistent white light
- Improved optical control

## Complete list of custom LED possibilities:

|  | Bridgelux Vera 10 LED possibilities |    | CRI  | Colour temp. | SDCM | Lm Output<br>T <sub>j</sub> = 25°C | Lm Output<br>T <sub>c</sub> = 85°C | Power | Current | Efficacy<br>T <sub>j</sub> = 25°C | Lifetime (70%)      |
|--|-------------------------------------|----|------|--------------|------|------------------------------------|------------------------------------|-------|---------|-----------------------------------|---------------------|
|  |                                     |    | Ra   | K            |      | Lm                                 | Lm                                 | W     | mA      | Lm/W                              | Hrs                 |
|  |                                     |    |      |              |      |                                    |                                    |       |         |                                   |                     |
| 2700K SDCM 3   | LED                                 | 80 | 2700 | 3            | 1080 | 940                                | 9.3                                | 350   | 116     | 50.000                            |                     |
|  | LED                                 | 90 | 2700 | 3            | 865  | 755                                | 9.3                                | 350   | 93      | 50.000                            | ← Standard supplied |
|  | LED                                 | 97 | 2700 | 3            | 690  | 605                                | 9.3                                | 350   | 74      | 50.000                            |                     |
| 2700K SDCM 2   | LED                                 | 80 | 2700 | 2            | 1080 | 940                                | 9.3                                | 350   | 116     | 50.000                            |                     |
|  | LED                                 | 90 | 2700 | 2            | 865  | 755                                | 9.3                                | 350   | 93      | 50.000                            |                     |
|  | LED                                 | 97 | 2700 | 2            | 690  | 605                                | 9.3                                | 350   | 74      | 50.000                            |                     |
| 3000K SDCM 3   | LED                                 | 80 | 3000 | 3            | 1120 | 975                                | 9.3                                | 350   | 120     | 50.000                            |                     |
|  | LED                                 | 90 | 3000 | 3            | 915  | 800                                | 9.3                                | 350   | 98      | 50.000                            | ← Standard supplied |
|  | LED                                 | 97 | 3000 | 3            | 755  | 655                                | 9.3                                | 350   | 81      | 50.000                            |                     |
| 3000K SDCM 2   | LED                                 | 80 | 3000 | 2            | 1120 | 975                                | 9.3                                | 350   | 120     | 50.000                            |                     |
|  | LED                                 | 90 | 3000 | 2            | 915  | 800                                | 9.3                                | 350   | 98      | 50.000                            |                     |
|  | LED                                 | 97 | 3000 | 2            | 755  | 655                                | 9.3                                | 350   | 81      | 50.000                            |                     |
| 4000K SDCM 3   | LED                                 | 80 | 4000 | 3            | 1180 | 1030                               | 9.3                                | 350   | 126     | 50.000                            |                     |
| 4000K SDCM 2   | LED                                 | 80 | 4000 | 2            | 1180 | 1030                               | 9.3                                | 350   | 126     | 50.000                            |                     |

When ordering luminaires with other than standard supplied LEDs, luminaire pricing & product delivery times may vary.

# How to replace LED lightsource Titan

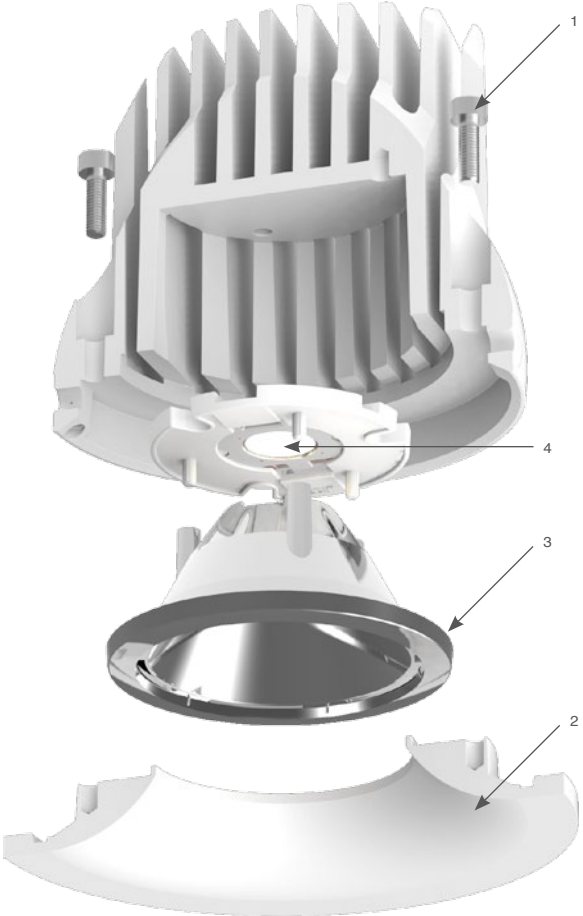

When unscrewing both screws (1) (DIN 912 M3x12), the frontplate (2) comes apart. This frontplate keeps the reflector (3) and the LED (4) in place. Be very careful when unplugging the LED (4) from the electrical connector (5)

**LED only to be replaced by a qualified electrician!!**

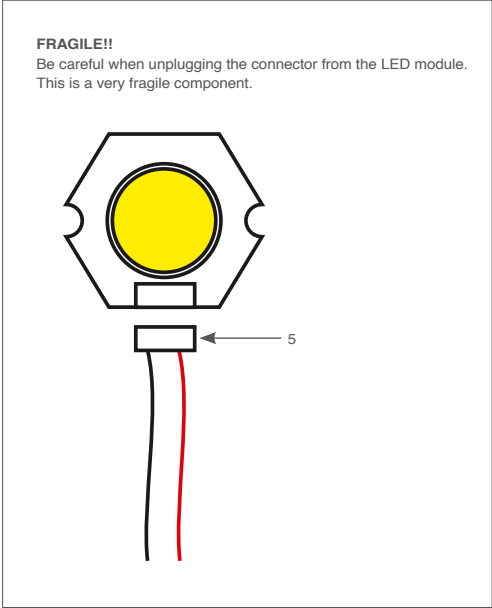



# Fortimo LED possibilities

## Fortimo SLM Module

For retail lighting applications it has long been recognized that high quality of white light is a key ingredient alongside an increasing awareness of the need for sustainable and highly efficient lighting solutions.

With the possibilities offered by the latest LED technology, lighting professionals are looking for the most compact and stylish luminaires, without any compromise on light quality and energy efficiency. The third generation of Fortimo LED SLM proves it is now possible to have a high quality alternative for halogen, compact fluorescent and even compact HID fixtures, without any compromise on light quality and energy efficiency, but with the benefits of using LED technology.

The versatility of the Fortimo LED SLM can be truly appreciated when considering light sources for the two main applications in retail lighting, being spot lighting and general downlighting. Fortimo LED SLM Gen3 covers the requirements of both types of application, by offering high energy efficiency combined with miniaturization, outstanding light quality and beam controllability.

Both compact stylish downlight fixtures, as well as powerful spot lighting solutions will benefit from this third generation of Fortimo LED SLM



5 Year **PHILIPS** warranty

Complete list of custom LED possibilities:

| Philips Fortimo LED possibilities | CRI typ. | R9 typ. | Colour temp. | SDCM | Lm Output | Voltage | Power | Current | LED efficacy | System efficacy | Lifetime (70%) |        |
|-----------------------------------|----------|---------|--------------|------|-----------|---------|-------|---------|--------------|-----------------|----------------|--------|
|                                   |          | Ra      | R9           |      | K         | Lm      | V     | W       | mA           | Lm/W            | Lm/W           | Hrs    |
| 2000lm                            | LED      | 82      | 20           | 3000 | 3         | 2070    | 34.8  | 17.4    | 350          | 119             | 104            | 50.000 |
|                                   | LED      | 82      | 20           | 4000 | 3         | 2200    | 34.8  | 17.4    | 350          | 126             | 110            | 50.000 |
|                                   | LED      | 97      | 80           | 3000 | 3         | 1690    | 34.8  | 17.4    | 350          | 97              | 84             | 50.000 |
|                                   | LED      | 97      | 80           | 4000 | 3         | 1820    | 34.8  | 17.4    | 350          | 104             | 91             | 50.000 |
| 3000lm                            | LED      | 82      | 20           | 3000 | 3         | 3060    | 34.6  | 25.9    | 350          | 118             | 103            | 50.000 |
|                                   | LED      | 82      | 20           | 4000 | 3         | 3270    | 34.6  | 25.9    | 350          | 126             | 110            | 50.000 |
|                                   | LED      | 97      | 80           | 3000 | 3         | 2470    | 34.6  | 25.9    | 350          | 95              | 83             | 50.000 |
|                                   | LED      | 97      | 80           | 4000 | 3         | 2680    | 34.6  | 25.9    | 350          | 103             | 90             | 50.000 |
| 4500lm                            | LED      | 82      | 20           | 3000 | 3         | 4860    | 35.2  | 35.2    | 350          | 115             | 100            | 50.000 |
|                                   | LED      | 82      | 20           | 4000 | 3         | 5200    | 35.2  | 35.2    | 350          | 123             | 107            | 50.000 |
|                                   | LED      | 97      | 80           | 3000 | 3         | 3930    | 35.2  | 35.2    | 350          | 93              | 81             | 50.000 |
|                                   | LED      | 97      | 80           | 4000 | 3         | 4270    | 35.2  | 35.2    | 350          | 101             | 88             | 50.000 |
| Crisp White                       | LED      | 92      | 60           | CW   | 3         | 2970    | 35.5  | 33.7    | 350          | 88              | 77             | 50.000 |
|                                   | LED      | 92      | 60           | CW   | 3         | 3760    | 35.2  | 42.3    | 350          | 89              | 77             | 50.000 |
| Food                              | LED      | 90      | 65           | Food | 3         | 2740    | 35.2  | 42.3    | 350          | 65              | 56             | 50.000 |
| Meat                              | LED      | 90      | 90           | Meat | 3         | 2960    | 35.2  | 42.3    | 350          | 70              | 61             | 50.000 |

When ordering luminaires with other than standard supplied LEDs, luminaire pricing & product delivery times may vary.

# Food / Meat / Crisp White

## Color specs

|  | Color Temp. | CRI (Ra) | R9  | X     | Y     |
|--|-------------|----------|-----|-------|-------|
| <b>Philips Fortimo SLM Crisp White</b> | 3000K       | 90       | ≥50 | 0.430 | 0.395 |
| <b>Philips Fortimo SLM Food</b>        | 2600K       | 90       | ≥70 | 0.450 | 0.380 |
| <b>Philips Fortimo SLM Meat</b>        | 3100K       | 90       | ≥50 | 0.396 | 0.333 |

### Crisp White

Crisp white technology in Philips Fortimo SLM LEDs offers a whole new dimension in color perception.

First of all with a CRI of min. Ra90 (typical Ra97) colors are displayed very accurately and become very rich.

Apart from the high CRI, these LEDs have the ability to display 'white' even more white.

Colors appear as if they were lighted by a 3000K lightsource and white tones appear as if they were lighted by a 4000K lightsource, all in one single LED module.

Crisp white is ideal for retail applications, giving a light perception that surpasses the well known results of CDM Elite lightsource solutions.

### Food & Meat

For food and meat special lighting is required. Fortimo SLM food and Fortimo SLM meat LED modules offer the perfect solution.

Both these LEDs have a high R9 value, a color value that is not included in the standard CRI. The R9 value is important for the appearance of pure reds.

Most lightsources have a very poor R9 value, resulting in a greyish look of pure reds.

Also these LED modules have a specific light color, unique for food and meat.

Philips food and meat LED modules are the perfect mix and guarantees you to enhance the perception of freshness and attractiveness of food and meat.

# Fortimo Cooling

The latest Philips Fortimo SLM technology performs better than ever. The fourth generation LEDs have become very efficient, reducing energy and heat generation. Therefore in certain luminaires, passive cooling is possible in combination with Philips fortimo 2000lm and 3000lm LEDs. Active cooling remains necessary for 4500lm, crisp white, food and meat applications.

Optimal heat evacuation results in longer LED lifespan.

All fortimo SLM LEDs are protected against overheating.

In such case the LED continues to perform but at 15% of its max. output.

Once the overheating problem is solved, the LED re-performs at 100%



### Passive cooling:

For Philips fortimo SLM up to 3000lm

Heatsink should never be covered with isolation

Free circulation of air is necessary, 50mm free space is recommended



### Active cooling:

For Philips fortimo SLM 4500lm / Crisp white / Food / Meat

Fan produces 18dB.

Lifetime: 100k hours (2x the expected lifetime of the LED module)

Fans should never be covered with isolation

Free circulation of air is necessary, 100mm free space is recommended

# Custom-made profiles

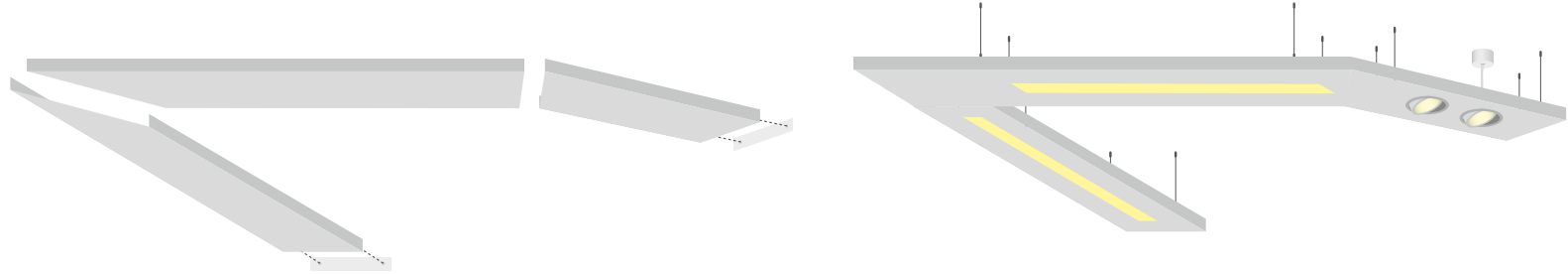

1. Specify what shape and size is needed.
2. Specify the total length
3. Specify the connectors that are needed
4. Specify the amount of end pieces

5. Specify the type of mounting
6. Choose the power connection
7. Choose extra options
8. Choose downlight-, T5- and/or LED Line modules.

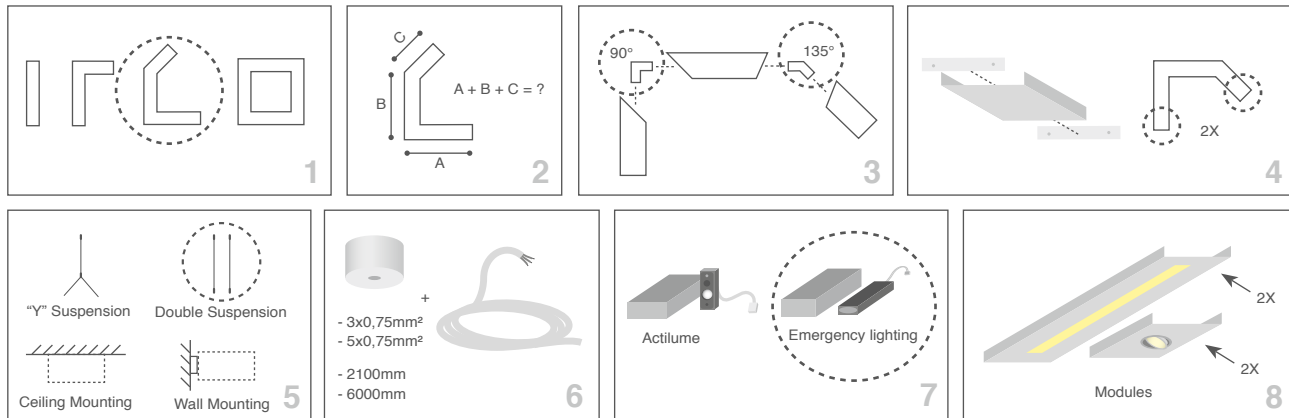

Doxis Profile catalogue

## Custom made Solutions:

- All shapes, lengths, colors, combinations, etc. upon request
- Download our latest catalogue (PDF) on [www.doxis.be](http://www.doxis.be)
- Ask a quotation at [info@doxis.be](mailto:info@doxis.be)

# Fortimo LED Line Systems

## Features and benefits:

A choice of systems, designed with specifications for different applications, allowing a wide assortment of fluorescent luminaires to be upgraded to LEDs.

Efficiency levels surpassing T5 and PL-L lamps.

High quality white light LED modules, meeting the European norms for Indoor lighting.

A linear shape of LED modules, specifically chosen for covering the widest variety of luminaire shapes from square to rectangular in all lengths and sizes with one building block.

Fortimo LED Line modules come as a system with the Xitanium 75W family of drivers in a linear housing matching T5 drivers, for easy incorporation in to existing luminaires.

The LED Line systems have been designed so that no further heat sink is needed.

Lifetime of 50k hours, due to the combination of LEDs and special Philips phosphor technology.

Fortimo LED Line modules have a low level of integration, whereby primary optics still need to be added, allowing luminaire manufacturers to create more differentiation in luminaire design.



5 Year **PHILIPS** warranty

| Philips Fortimo LEDLine<br>LED possibilities |   | Light output | Module efficacy | Power consumption | Colour rendering index | Colour temperature | Colour consistency | Life @ 70% lm maintenance |
|--|---|--------------|-----------------|-------------------|------------------------|--------------------|--------------------|---------------------------|
|  |   | lm           | lm/W            | W                 | Ra                     | K                  | SDCM               | K hrs                     |
| 1R LV  | Fortimo LED Line 1ft, 1100lm 830 1R LV2 | 1065         | 132             | 8.1               | >80                    | 3000               | 3.5                | 50                        |
|  | Fortimo LED Line 1ft, 1100lm 840 1R LV2 | 1110         | 137             | 8.1               | >80                    | 4000               | 3.5                | 50                        |
| 1R HV  | Fortimo LED Line 2ft, 2200lm 830 1R HV2 | 2135         | 132             | 16.2              | >80                    | 3000               | 3.5                | 50                        |
|  | Fortimo LED Line 2ft, 2200lm 840 1R HV2 | 2225         | 138             | 16.2              | >80                    | 4000               | 3.5                | 50                        |

NOTE! Profiles with low voltage modules used in combination with a polycarbonate cover may be installed as class 2 luminaires

# Fortimo LED Strip Systems

## Features and benefits:

In today's rapidly changing office market, demand is increasing for scalable, energy-efficient LED lighting solutions that enhance the workspace, supporting both staff well-being and corporate image. In this evolving environment, luminaire manufacturers want a component that offers fluorescent replacement solutions and that will allow them to create slender, seamless light-lines that do not compromise on the light quality their customers are used to.

Fortimo LED Strip is a sleek linear LED array with a fixed form factor and consistent high-quality white light making it possible to create new slimline designs that go beyond traditional fluorescent office applications. Supported with a state-of-the-art Xitanium driver, it is easy to design-in, enabling fast luminaire creation.

And because this energy-efficient system is scalable and upgradable, it offers a truly future-proof solution.



5 Year **PHILIPS** warranty

| Fortimo LED Line LV |  | Light output | Module efficacy | Power consumption | Colour rendering index | Colour temperature | Colour consistency | Life @ 70% lm maintenance |
|---------------------|--|--------------|-----------------|-------------------|------------------------|--------------------|--------------------|---------------------------|
|                     |  | lm           | lm/W            | W                 | Ra                     | K                  | SDCM               | K hrs                     |
| 1R                  | Fortimo LED Strip 1ft 650lm 830 1R LV1 | 610          | 126             | 4,9               | >80                    | 3000               | 3.5                | 50                        |

# Comparison LED vs. T5

T5:

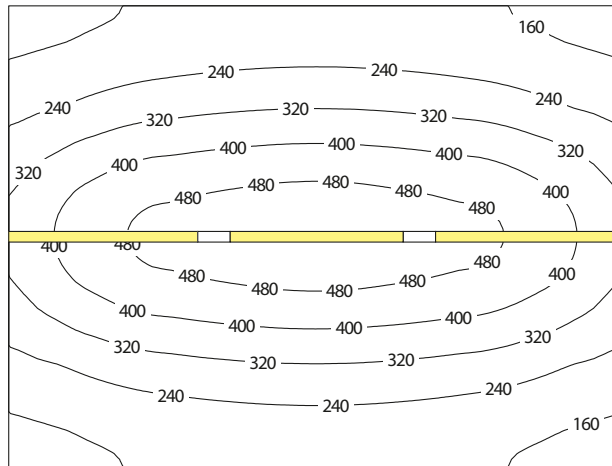

LEDLine:

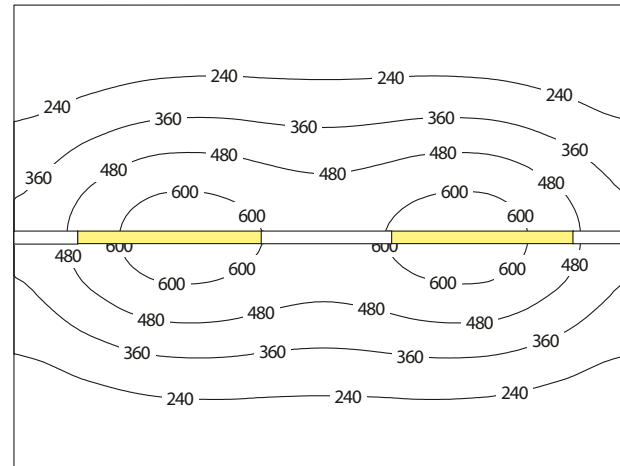

|                      | T5  | LED Line   |
|----------------------|---|--|
| Room dimensions      | L 4m - W 3m - H 2,8m                                | L 4m - W 3m - H 2,8m                               |
| Mounting height      | 2,2m  | 2,2m   |
| Average light output | 316lux  | 346lux   |
| Power consumption    | 177W  | 80W  |
| Light output         | 14,75W/m <sup>2</sup> = 4,67W/m <sup>2</sup> /100lx | 6,67W/m <sup>2</sup> = 1,93W/m <sup>2</sup> /100lx |

LED Line saves up to 60% of energy

# Xtitanium Drivers + Accessories

## Information

Xtitanium LED drivers are specially designed to operate LED solutions for general lighting applications like for: down/spot lighting (point sources) and linear office lighting. These LED drivers feature specific flexibility and reliability specifications:

Flexibility to enable LED generation management (future proof) and complexity management  
Operating windows enabling adjustable output current (AOC)  
"3 in 1" modern housing designs to address built-in & independent driver designs  
Various housing design derived from popular conventional lamp drivers/ballasts  
Various dimming protocols: DALI, Touch & DALI, 1-10V and Trailing edge  
DALI drivers are fully programmable (AOC, Temperature derating, CLO) with Philips MultiOne configurator tool

## Reliability:

High reliability is ensured by making use of experience and knowledge of conventional lamp technologies  
Xtitanium LED drivers integrate special general lighting features that increase reliability even further  
Thermal derating to protect LED module  
12V out for fan supply or decorative LED effects  
Hot wiring to protect LED module  
Lower ripple currents to safeguard lifetime of LED module  
Central DC operation



## Accessories

### Actilume Daylight- & Movement Sensor

The ActiLume system provides huge energy savings, maximum comfort and is also a tool for fighting climate change on our planet. ActiLume is designed to fulfill the needs of open-plan and cell offices, but can also be adjusted to suit other applications. It combines energy-saving functions with simple possibilities for user interaction. ActiLume has the facility for manual interaction by means of a push-button or an IR control. Philips ActiLume is a new simple method of installing and using lighting control systems in offices. With ActiLume you get maximum comfort and automatic energy savings of up to 70 - 75%.



### Emergency Lighting

Philips TrustSight LED emergency kits come complete with battery packs. Designed for use with -current control LED drivers, they operate as a de-centralized emergency lighting solution in the event of a mains voltage failure. TrustSight LED emergency kit is compatible with most LED control gear on the market. They support applications requiring 1 or 3 hours operating time and are CE and ENEC-certified.



Actilume Daylight Sensor



# Wiring

## Standard wiring: Single supply

Not dimmable:



Dimmable 1-10V:

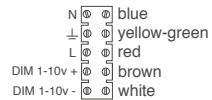

Dali dimmable:



## Optional wiring: Single N Second supply

Not dimmable:

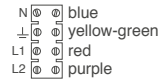

Dimmable 1-10V:

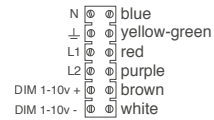

Dali dimmable:

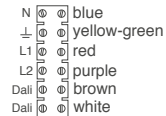

## Optional wiring: Double N Second supply

Not dimmable:

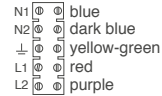

Dimmable 1-10V:



Dali dimmable:



# Concrete build-in solutions

For building-in luminaires into concrete ceilings, doxis recommends using kaisersboxes (Kaiser DE, Helia BE, Agro CH). More information can be found on the Dosis website or on the websites of Kaiser, Helia or Agro.



[www.kaiser-elektro.de](http://www.kaiser-elektro.de)

[www.helia-elektro.be](http://www.helia-elektro.be)

[www.agro.ch](http://www.agro.ch)

# IEC 1931 + SDCM

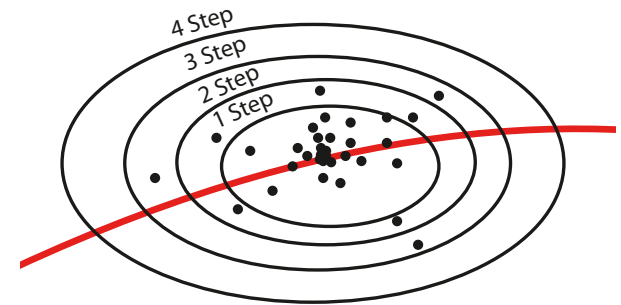
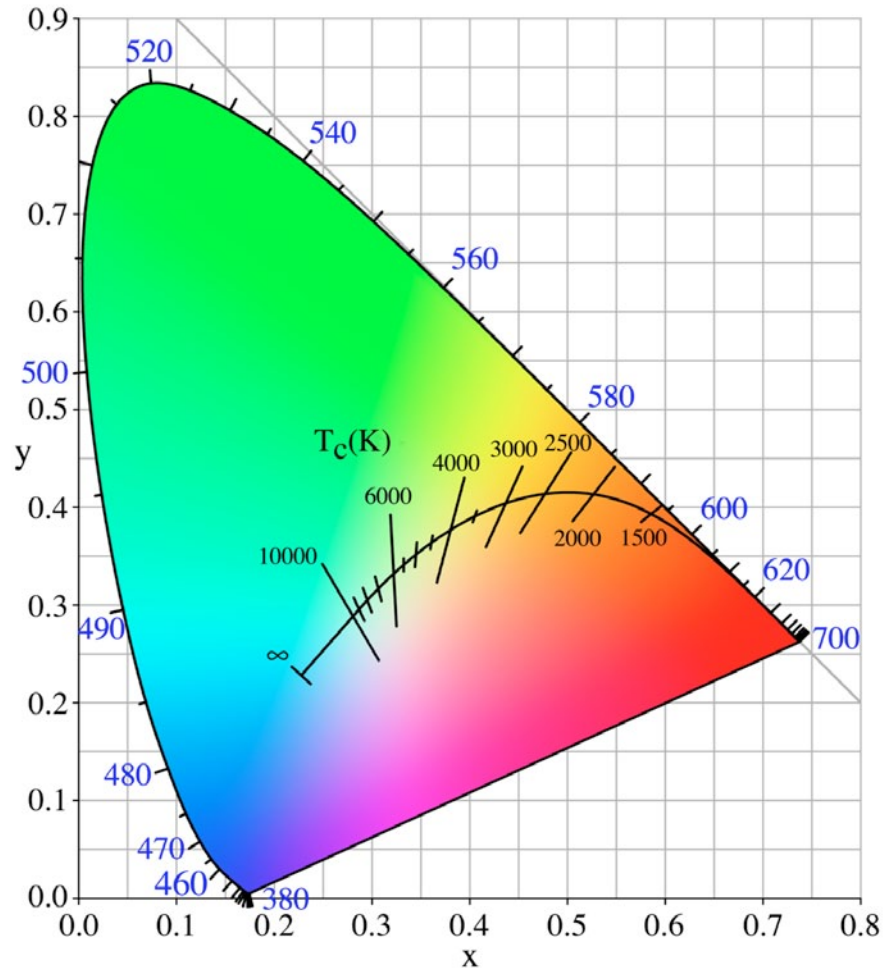

# Article number index

## Downlights

|            |  |       |            |   |    |
|------------|--|-------|------------|---|----|
| 414.xx.xx  | Collector Recessed Single.....         | 40    | 1016.xx.xx | Titan Trimless Standard Cone .....            | 56 |
| 415.xx.xx  | Collector Recessed Single.....         | 40    | 1017.xx.xx | Titan Trimless Standard Organic .....         | 56 |
| 416.xx.xx  | Collector Recessed Single.....         | 40    | 1018.xx.xx | Titan Trimless Standard Anti-glare.....       | 56 |
| 418.xx.xx  | Breeze Mix.....                        | 12    | 1019.xx.xx | Titan Trimless Deep Cone .....                | 58 |
| 424.xx.xx  | Collector Trimless Double.....         | 68    | 1020.xx.xx | Titan Trimless Deep Organic .....             | 58 |
| 425.xx.xx  | Collector Trimless Triple .....        | 68    | 1021.xx.xx | Titan Trimless Deep Anti-glare.....           | 58 |
| 430.xx.xx  | Turn Me .....                          | 12    | 1022.xx.xx | Titan Trimless Square Cone .....              | 60 |
| 440.xx.xx  | Many Square 2 .....                    | 42-44 | 1023.xx.xx | Titan Trimless Square Organic .....           | 60 |
| 443.xx.xx  | Many Trimless.....                     | 64    | 1024.xx.xx | Titan Trimless Square Anti-glare.....         | 60 |
| 444.xx.xx  | Many Slim.....                         | 42-44 | 1025.xx.xx | Titan Trimless Double Square Cone.....        | 62 |
| 446.xx.xx  | Collector Trimless Square Single.....  | 66    | 1026.xx.xx | Titan Trimless Double Square Organic.....     | 62 |
| 447.xx.xx  | Collector Trimless Square Double ..... | 66    | 1027.xx.xx | Titan Trimless Double Square Anti-glare ..... | 62 |
| 448.xx.xx  | Collector Trimless Square Triple.....  | 66    | 1100.xx.xx | Titan Double Rectangle Cone.....              | 38 |
| 449.xx.xx  | Kana Square.....                       | 46-48 | 1101.xx.xx | Titan Double Rectangle Anti-glare .....       | 38 |
| 465.xx.xx  | FlatLED T1.....                        | 8     | 1102.xx.xx | Titan Double Rectangle Organic.....           | 38 |
| 465.xx.xx  | FlatLED T2.....                        | 10    | 1103.xx.xx | Titan Double Oval Cone .....                  | 34 |
| 482.xx.xx  | Agati.....                             | 12    | 1104.xx.xx | Titan Double Oval Anti-glare.....             | 34 |
| 484.xx.xx  | Kana Round.....                        | 54    | 1105.xx.xx | Titan Double Oval Organic .....               | 34 |
| 487.xx.xx  | Kuda Round.....                        | 50-52 | 1106.xx.xx | Titan Double 8 Cone.....                      | 36 |
| 495.xx.xx  | Saturnus .....                         | 54    | 1107.xx.xx | Titan Double 8 Anti-glare .....               | 36 |
| 496.xx.xx  | Kuda Square.....                       | 50-52 | 1108.xx.xx | Titan Double 8 Organic.....                   | 36 |
| 498.xx.xx  | Phantom 50 Single .....                | 70    | 1109.xx.xx | Titan 1-Way Cone .....                        | 24 |
| 498.xx.xx  | Phantom 111 Single.....                | 72-74 | 1110.xx.xx | Titan 1-Way Organic .....                     | 24 |
| 499.xx.xx  | Phantom 50 Double .....                | 70    | 1111.xx.xx | Titan 1-Way Anti-glare .....                  | 24 |
| 499.xx.xx  | Phantom 111 Double .....               | 72-74 | 1112.xx.xx | Titan 2-Way Cone .....                        | 26 |
| 1000.xx.xx | Titan Fix Square Anti-glare.....       | 18    | 1113.xx.xx | Titan 2-Way Organic .....                     | 26 |
| 1001.xx.xx | Titan Fix Square Organic.....          | 18    | 1114.xx.xx | Titan 2-Way Anti-glare .....                  | 26 |
| 1003.xx.xx | Titan Fix Square Cone .....            | 18    | 1115.xx.xx | Titan 3-Way Cone .....                        | 28 |
| 1004.xx.xx | Titan Mix Square Organic .....         | 20    | 1116.xx.xx | Titan 3-Way Organic .....                     | 28 |
| 1005.xx.xx | Titan Mix Square Anti-glare .....      | 20    | 1117.xx.xx | Titan 3-Way Anti-glare .....                  | 28 |
| 1006.xx.xx | Titan Mix Square Cone .....            | 20    | 1118.xx.xx | Titan 4-Way Cone .....                        | 30 |
| 1007.xx.xx | Titan Fix Round Cone.....              | 14    | 1119.xx.xx | Titan 4-Way Organic .....                     | 30 |
| 1008.xx.xx | Titan Fix Round Organic.....           | 14    | 1120.xx.xx | Titan 4-Way Anti-glare .....                  | 30 |
| 1009.xx.xx | Titan Fix Round Anti-glare .....       | 14    | 1121.xx.xx | Titan 4-Way Square Cone .....                 | 32 |
| 1010.xx.xx | Titan Mix Round Cone .....             | 16    | 1122.xx.xx | Titan 4-Way Square Organic .....              | 32 |
| 1011.xx.xx | Titan Mix Round Organic .....          | 16    | 1123.xx.xx | Titan 4-Way Square Anti-glare.....            | 32 |
| 1012.xx.xx | Titan Mix Round Anti-glare .....       | 16    |            |   |    |
| 1014.xx.xx | Titan Ip54 Square .....                | 22    |            |   |    |
| 1015.xx.xx | Titan Ip54 Round .....                 | 22    |            |   |    |

## Suspended / Surface mounted

|            |                                       |    |
|------------|---------------------------------------|----|
| 101.xx.xx  | Rondo Small.....                      | 80 |
| 101.xx.xx  | Rondo Large.....                      | 80 |
| 102.xx.xx  | Cube Small.....                       | 78 |
| 102.xx.xx  | Cube Large.....                       | 78 |
| 373.xx.xx  | Moody Base.....                       | 86 |
| 374.xx.xx  | Moody 3-Phase.....                    | 86 |
| 491.xx.xx  | Collector Box Single.....             | 88 |
| 492.xx.xx  | Collector Box Double.....             | 88 |
| 493.xx.xx  | Collector Box Triple.....             | 88 |
| 1200.xx.xx | Titan Semi-Recessed Cone.....         | 82 |
| 1201.xx.xx | Titan Semi-Recessed Organic.....      | 82 |
| 1202.xx.xx | Titan Semi-Recessed Anti-glare.....   | 82 |
| 1204.xx.xx | Titan Surface Mounted Cone.....       | 84 |
| 1205.xx.xx | Titan Surface Mounted Organic.....    | 84 |
| 1206.xx.xx | Titan Surface Mounted Anti-glare..... | 84 |
| 1306.xx.xx | Titan Arm 2-Way Cone.....             | 96 |
| 1307.xx.xx | Titan Arm 2-Way Organic.....          | 96 |
| 1308.xx.xx | Titan Arm 2-Way Anti-glare.....       | 96 |
| 1309.xx.xx | Titan Arm 4-Way Cone.....             | 98 |
| 1310.xx.xx | Titan Arm 4-Way Organic.....          | 98 |
| 1311.xx.xx | Titan Arm 4-Way Anti-glare.....       | 98 |
| 1400.xx.xx | Titan Suspended Cone.....             | 92 |
| 1401.xx.xx | Titan Suspended Organic.....          | 92 |
| 1402.xx.xx | Titan Suspended Anti-glare.....       | 92 |
| 1403.xx.xx | Titan Suspended T2 Cone.....          | 94 |
| 1404.xx.xx | Titan Suspended T2 Organic.....       | 94 |
| 1405.xx.xx | Titan Suspended T2 Anti-glare.....    | 94 |
| 1406.xx.xx | Titan Box Cone.....                   | 90 |
| 1407.xx.xx | Titan Box Organic.....                | 90 |
| 1408.xx.xx | Titan Box Anti-glare.....             | 90 |

## Lounge

|            |                                      |     |
|------------|--------------------------------------|-----|
| 100.xx.xx  | Full Moon 400.....                   | 106 |
| 105.xx.xx  | Dome.....                            | 108 |
| 142.xx.xx  | Eclipse Suspended.....               | 114 |
| 143.xx.xx  | Eclipse Surface Mounted.....         | 112 |
| 145.xx.xx  | Globe Suspended.....                 | 114 |
| 146.xx.xx  | Globe Surface Mounted.....           | 112 |
| 160.xx.xx  | Full Moon 600.....                   | 106 |
| 190.xx.xx  | Full Moon 900.....                   | 106 |
| 319.xx.xx  | Tunnel Vertical.....                 | 102 |
| 319.xx.xx  | Tunnel Vertical Double / Triple..... | 104 |
| 322.xx.xx  | Tube Recessed.....                   | 110 |
| 325.xx.xx  | Palladium T2.....                    | 116 |
| 336.xx.xx  | Palladium.....                       | 116 |
| 340.xx.xx  | Palladium.....                       | 116 |
| 341.xx.xx  | Palladino.....                       | 116 |
| 352.xx.xx  | Palladium.....                       | 116 |
| 376.xx.xx  | Palladium T2.....                    | 116 |
| 384.xx.xx  | Tube Surface Mounted.....            | 110 |
| 1100.xx.xx | Full Moon 1100.....                  | 106 |

## Outdoor

|           |                           |     |
|-----------|---------------------------|-----|
| 120.xx.xx | Vertex Up/Down.....       | 124 |
| 122.xx.xx | Vertex Down.....          | 124 |
| 124.xx.xx | Vertex Double Down.....   | 124 |
| 231.xx.xx | Terra Round.....          | 122 |
| 232.xx.xx | Terra Round HIT.....      | 122 |
| 233.xx.xx | Terra Round Hit Asym..... | 122 |
| 234.xx.xx | Terra Square.....         | 122 |
| 245.xx.xx | Radar Superlow.....       | 126 |
| 252.xx.xx | Diva.....                 | 128 |

## Profiles

|           |                            |     |
|-----------|----------------------------|-----|
| 600.xx.xx | LEDLiner20.....            | 154 |
| 660.xx.xx | LEDLiner190 Symmetric..... | 146 |
| 660.xx.xx | LEDLiner190 FlatLED.....   | 148 |
| 750.xx.xx | LEDLiner45 Down.....       | 136 |
| 750.xx.xx | LEDLiner45 Up / Down.....  | 138 |
| 750.xx.xx | LEDLiner45 Wall.....       | 140 |
| 751.xx.xx | LEDLiner65 Recessed.....   | 134 |
| 760.xx.xx | LEDLiner45 Recessed.....   | 132 |
| 770.xx.xx | LEDLiner65.....            | 142 |
| 780.xx.xx | LEDLiner140 Asym Down..... | 144 |
| 855.xx.xx | Amazon LEDLine.....        | 150 |
| 855.xx.xx | Amazon Titan.....          | 152 |

# Doxis



## Visit our website

For detailed specifications of products  
For product imagery  
For datasheets  
For mounting instructions  
For photometric data  
For the most recent products and updates  
And much more...

[www.doxis.be](http://www.doxis.be)

## Service

We serve dealers in more than 20 countries.

Wij spreken nederlands.  
Nous parlons français.  
We speak English.  
Wir sprechen Deutsch.

Quality, customer-support and short delays is what we stand for. Long-term partnership is what we are looking for.

## Shipment

We do ship orders to Belgium, the Netherlands, Luxembourg, Germany, France, Austria and Switzerland. Ask for our transport prices, terms and conditions.

Other countries: ex-works

DOXIS LIGHTING FACTORY NV  
Horizonlaan 30  
B-3600 Genk  
T +32(0)89/62.15.11  
F +32(0)89/62.15.12  
info@doxis.be  
www.doxis.be

**DOXIS**  
LIGHTING FACTORY

## Algemene Verkoopvoorwaarden.

- Goederen worden verzonden tegen onze algemene verkoopvoorwaarden.
- Onze offertes hebben een geldigheidsduur van 3 maanden of zijn geldig totdat er een algemene prijsverhoging optreedt op de prijslijst van Doxis Lighting Factory NV die eerst van toepassing komt.
- Wij nemen de nodige maatregelen om de leveringstermijnen te eerbiedigen en nemen geen vertragspenaliteiten aan.
- Bij annulatie van een bestelling, zelfs zo deze annulatie slechts gedeeltelijk is door de koper, is deze gehouden tot betaling van een schadevergoeding van minimum 30% van de prijs van de geannuleerde gedeeltelijk is. Wij behouden ons het recht voor deze schadevergoeding te verhogen tot het door ons geleden verlies, indien wij reeds aanvang hebben genomen met de uitvoering of de voorbereiding van de bestelling.
- De verdragging in de levering kan in geen geval aanleiding geven tot annulatie der bestelling.
- De goederen reizen op gevaar en voor risico van de bestemmeling.
- Iedere klacht, om geldig te zijn, dient schriftelijk en ten laatste binnen de 5 dagen volgend op de ontvangst der goederen, bij onze firma ingediend te worden. Bij alle facturen zijn betaalbaar op onze uitbalanszaten te Genk.
- Behoudens tegenstrijdige bepaling, mogen onze agenten of vertegenwoordigers het bedrag van de factuur niet inkasseren. 10. Het wisselkoersrisico is ten laste van de koper. 11. Behoudens andersluidende en schriftelijke bepaling, zijn onze facturen betaalbaar op 30 dagen factuurdatum.
- Elk bedrag dat ontoelaagd blijft op zijn vervaldag, zal van rechtswege en zonder ingebrekestelling rente geven berekend op basis van de Belgische wettelijke instelling vermeerderd met 2 %, met een minimum intrestvoet van 12 %.
- In geval van niet-betaling op de vervaldag, behouden wij ons het recht voor het bedrag van de factuur met 10 % te verhogen, met een minimum van 250 €.
- De nietbetaling op de vervaldag van één enkele factuur, maakt het verschuldigd saldo van al de andere, zelfs niet vervallen facturen, van rechtswege onmiddellijk opeisbaar.
- Wanneer de koper nalatig zijn verbintenissen uit te voeren, kan de verkoop van rechtswege en zonder ingebrekestelling ontbonden zijn, onverminderd onze rechten op alle schadevergoedingen en interesten. De wilsuiting hiertoe p/ aangekondigd schrijven door ons zal hiervoor volstaan. 16. Indien ons vertrouwen in de kredietwaardigheid van de koper geschoot wordt door daden van gerechtelijke uitvoering tegen de koper en/of aanwijsbare andere gebeurtenissen, die het vertrouwen in de goede uitvoering van de door de koper aangegane verbintenissen in vraag stellen en/of onmogelijk maken, behouden wij ons het recht voor, zelfs indien de goederen reeds geheel of gedeeltelijk werden verzonden, de gehele bestelling of een gedeelte ervan op te schorten en van de koper geschikte waarborgen te eisen. Indien de koper weigert hierop in te gaan, behouden wij ons het recht voor de gehele bestelling of een gedeelte daarvan te annuleren. Dit is onverminderd onze rechten op alle schadevergoedingen en interesten.
- 17. EIGENDOMS-OORBEHOUD:** De goederen blijven onze eigendom tot volledige betaling van de prijs. Alle risico's zijn ten laste van de koper. De betaalde voorschotten blijven ons verworven ter vergoeding van de mogelijke verliezen bij wederverkoop. Ingeval de koper de aan ons toebehorende goederen, zelfs verwerkt, herverkoopt, draagt hij vanaf heden aan ons alle schuldvorderingen over die voortkomen uit deze herverkoop.
- Elk tekort aan en/of aanvaarden van wissels of andere verhandelbare documenten, houdt geen schuldvernieuwing in en vormt geen afwijking van de verkoopvoorwaarden.
- Behoudens schriftelijke overeengekomen afwijking is op de overeenkomst steeds het Belgisch Recht van toepassing. Ingeval van betwisting is enkel de rechtbank van Tongeren, België bevoegd.
- Reparatiekosten worden niet door Doxis geaccepteerd tenzij deze vooraf bevestigd en goedgekeurd zijn door Doxis, ook wanneer de verantwoordelijkheid voor deze reparatie bij Doxis ligt.

## Conditions Générales de Vente.

- Nos conditions de vente s'appliquent à toutes nos livraisons, offres, commandes, factures, .....
- Nos offres ont une durée de validité de 3 mois ou une durée de validité jusqu'à prochaine augmentation de prix en générale sur la liste de prix de Doxis Lighting Factory NV, lequel des deux qui vient le premier.
- Nous prenons toutes nos dispositions pour respecter les délais de livraison et nous n'acceptons aucune pénalité de retard.
- En cas d'annulation d'une commande, le client sera tenu à payer une indemnité de 30% minimum de prix de la commande. Nous nous réservons le droit d'augmenter celle indemnité au montant de la perte réellement subie par nous si la préparation de la commande a été entamée.
- Le retard dans la livraison ne peut, en aucun cas, donner lieu à l'annulation de la commande.
- Les marchandises sont expédiées aux risques et périls du destinataire.
- Toute réclamation pour être valable doit être faite par écrit à notre firme au plus tard dans les 5 jours qui suivent la réception de la marchandise.
- Toutes les factures sont payable au siège d'exploitation à Genk. 9. Nos agents ou représentants n'ont pas qualité pour encaisser le montant de la facture sauf stipulation expresse.
- Le risque de change est à charge de l'acheteur.
- Sauf stipulation contraire et écrite, nos factures sont payables à 30 jours date de facturation.
- Tout somme non payée à l'échéance porte de plein droit et sans mise en demeure intérêt au taux d'intérêt légal belge majoré de 2 %, avec un taux d'intérêt de 12 % au minimum.
- En cas de non-paiement d'une facture à son échéance, nous nous réservons le droit d'augmenter son montant de 10 % avec un minimum de 250 €.
- Le non-paiement d'une seule facture à son échéance rend exigible de plein droit le solde dû sur toutes les autres factures, même non échues.
- En cas d'exécution par l'acheteur de ses obligations, la vente pourra être résolue de plein droit sans mise en demeure, et ce sans préjudice de nos droits à tous dommages et intérêts. Notre volonté sera suffisamment manifestée par l'envoi d'une lettre recommandée. 16. S'il nous apparaît que le crédit de l'acheteur se détériore, notamment s'il y a des mesures d'exécution judiciaire prises contre l'acheteur et/ou en cas d'événements qui mettent en question la bonne exécution des engagements pris ou les rendent impossible, nous nous réservons le droit, même si les marchandises ont déjà été totalement ou partiellement expédiées, de suspendre totalement ou partiellement la commande et d'exiger les garanties nécessaires. En cas de refus de l'acheteur, nous nous réservons le droit d'annuler entièrement ou partiellement la commande. Tout ceci sans préjudice de nos droits à tous dommages et intérêts. **CLAUSE DE RESERVE DE PROPRIETE.** Nous nous réservons la propriété des marchandises jusqu'au complet paiement. Les risques sont à charge de l'acheteur. Les acomptes pourront être conservés pour couvrir les pertes éventuelles à la revente.
- En cas de revente des marchandises, même transformées, nous appartenant, l'acheteur nous cède dès à présent toutes les créances résultant de leur revente. 19. Le fait de tirer et/ou d'accepter des traites ou d'autres documents négociables, n'opère aucune novation de créance et ne déroge pas aux conditions de vente présentes.
- Sauf convention écrite contraire, le Droit Belge est le droit applicable à la convention. En cas de contestation le Tribunal de Tongres est compétent.
- Les frais de réparation ne seront pas acceptés par Doxis à moins qu'ils sont approuvés et confirmés d'avance par Doxis. Ceci même si la responsabilité pour ces frais est de la part de Doxis.

## Algemene Verkoopvoorwaarden.

- Es gelten ausschließlich unsere allgemeinen Geschäftsbedingungen.
- Schriftliche Angebote haben eine Gültigkeitsdauer von 3 Monate, bzw. Bis zum erscheinen einer neuen Preisliste.
- Wir nehmen die nötigen Massnahmen um die Lieferungsfristen einzuhalten und nehmen keine Verzögerungsstrafkanten an.
- Wir eine Bestellung durch den Käufer storniert, kann eine Gebühr von bis zu 30% des Netto Warenwertes erhoben werden. Wenn die tatsächlich entstandenen Kosten höher sind (Sonderkonstruktionen), kann dieser Betrag auch überschritten werden.
- Die Lieferungsverzögerung darf auf keinen Fall zu einer Streichung der Bestellung Veranlassung geben.
- Die Waren reisen auf Rechnung und Gefahr des Empfängers.
- Jeder Einspruch un gültig zu sein muss innerhalb von 5 Tagen nach dem Empfang der Waren schriftlich an unserer Firma übermittelt werden.
- Alle Rechnungen sind auf unsere Gewerbesitz in Genk zahlbar.
- Ausser formellen Vereinbarungen dürfen unsere Agenten oder Vertreter den Betrag der Rechnung nicht kassieren.
- Das Wechselrisiko ist zu Lasten des Käufers.
- Vorbehaltlicher gegenseitlicher Bestimmung sind unsere Rechnungen zahlbar : 30 Tage Rechnungsdatum.
- Jeder Betrag, der bei Verfall unbezahlt bleibt, wird mit vollem Recht und ohne Inverzugsetzung Zinsen bringen, auf Basis von den belgischen gesetzlichen Zinssatz erhöht um 2 %, mit einem Minimumzinssatz von 12 %
- Falls eine Rechnung beim Verfall unbezahlt ist, behalten wir uns das Recht vor den Betrag um 10 % zu erhöhen, mit einem Minimum von 250 €.
- Die Nichtzahlung einer einzigen Rechnung bei Verfall macht den geschuldeten Saldo von jeder andere selbst noch nicht fällig gewordenen Rechnung mit vollem Recht einlagbar.
- Falls der Käufer seine Verpflichtungen nicht vollzieht, dann kann der Verkauf von Rechts wegen und ohne Inverzugsetzung rückgängig

- gemacht werden, unbeschadet unserer Rechte auf Schadenersatz und Zinsen. Unserer Willensakt vor Einschreiben wird dazu genügen.
- Wenn sich die Bonität des Käufers nachweisbar verschlechtert, durch gerichtliche Verfügungen, Wechselproteste oder sonstige negative Zwischenfälle, behielten wir uns das Recht vor, auch nachdem die Ware schon ganz oder teilweise zum Versand gebracht wurde, die Bestellung ganz oder teilweise ein zu stellen und vom Käufer geeignete Garantien zur Erlösung der eingegangenen Verpflichtungen zu fordern. Falls diese Garantien uns nicht zufriedenstellen, behalten wir uns vor, die Bestellung ganz oder teilweise zu annullieren. Diese Aktionen sind unbeschadet unserer Rechte auf Schadenersatz und Zinsen.
- 17. EIGENTUMSVORBEHALT:** 17/1. Die Ware bleibt bis zur vollen Bezahlung sämtlicher Forderungen, einschliesslich Nebenforderungen, Schenkungsersatz, Rückzahlungen und Einlösen von Wechseln, Eigentum des Verkäufers. 17/2. Der Eigentumsvorbehalt bleibt auch dann bestehen, wenn einzelne Forderungen des Verkäufers in eine laufende Rechnung aufgenommen werden und der Saldo gezogen und anerkannt wird. 17/3. Wird Vorbehaltsware vom Käufer zu einer neuen beweglichen Sache verarbeitet, so erfolgt die Verarbeitung für den Verkäufer, ohne dass dieser hieraus verpflichtet wird. Die neue Sache wird dann Eigentum des Verkäufers. Bei Verkauf, Vermischung oder Vermengung mit nicht dem Verkäufer gehörender Ware erwirbt der Verkäufer Miteigentum an der neuen Sache nach dem Verhältnis des Fakturenwertes seiner Vorbehaltsware zum Gesamtwert. 17/4. Der Käufer ist zur Weiterveräußerung, zur Weiterverarbeitung oder zum Einbau der Vorbehaltsware unter Berücksichtigung der nachfolgenden Bestimmungen und nur mit der Messgabe berechtigt, dass die Forderungen gemäss Ziffer 6. auf den Verkäufer auch tatsächlich übergehen : 17/5. Die Belugnisse des Käufers, im ordnungsgemässen Geschäftsverkehr Vorbehaltsware zu veräußern, zu verarbeiten oder einzubauen, enden mit dem Widerruf durch den Verkäufer infolge einer nachträglichen Verschlechterung der Vermögenslage des Käufers, spätestens jedoch mit seiner Zahlungseinstellung oder mit der Benrtragung bzw. Eröffnung des Konkurs- oder Vergleichsverfahrens über sein Vermögen. 17/6. a) Der Käufer tritt hiermit die Forderung mit allen Nebenrechten aus dem Weiterverkauf der Vorbehaltsware - einschliesslich etwaiger Saldoforderungen - an den Verkäufer ab. b) Würde die Ware verarbeitet, vermisch oder vermengt und hat der Verkäufer hieran in Höhe seines Fakturenwertes Miteigentum erlangt, steht ihm die Kaufpreisforderung anteilig zum Wert seiner Rechte an der Ware zu. c) Wird Vorbehaltsware vom Käufer in ein Grundstück eingebaut, so tritt der Käufer schon jetzt die daraus entstehende Forderung auf Vergütung in Höhe des Fakturenwertes der Vorbehaltsware mit allen Nebenrechten einschliesslich eines solchen auf Einräumung einer Sicherungshypothek mit Rang vor dem Rest ab. Hat der Käufer die Forderung im Rahmen des echten Factorings verkauft, wird die Forderung des Verkäufers sofort fällig und der Käufer tritt die an ihre Stelle tretende Forderung gegen den Factor an den Verkäufer ab und leitet seinen Verkaufserlös unverzüglich an den Verkäufer weiter. Der Verkäufer nimmt diese Abtretung an. 17/7. Der Käufer ist ermächtigt, solange er seinen Zahlungsverpflichtungen nachkommt, die abgetretenen Forderungen einzuziehen. Die Einziehungsermächtigung erlischt bei Widerruf, spätestens aber bei Zahlungsverzug des Käufers oder bei wesentlicher Verschlechterung der Vermögensverhältnisse des Käufers. In diesem Fall wird der Verkäufer hiermit vom Käufer bevollmächtigt, die Abtretung von der Abtretung zu unterrichten und die Forderungen zurückzufordern. Der Käufer verpflichtet dem Verkäufer auf Verlangen eine genaue Aufstellung aller dem Verkäufer zustehenden Forderungen mit Namen und Anschrift der Abnehmer, Höhe der einzelnen Forderungen, Rechnungsdatum usw. auszuhandeln und dem Verkäufer alle für die Geltendmachung der abgetretenen Forderungen notwendigen Auskünfte zu erteilen und die Überprüfung dieser Auskünfte zu gestatten. 17/8. Übersteigt der Fakturenwert der für den Verkäufer bestehenden Sicherheit dessen sämtliche Forderungen einschliesslich Nebenforderungen (z.B. um mehr als 20 %, so ist der Verkäufer auf Verlangen des Käufers oder eines durch die Übersicherung des Verkäufers beeinträchtigten Dritten insoweit zur Freigabe von Sicherungen nach Wahl des Verkäufers verpflichtet. 17/9. Verpfändung oder Sicherungsübereignung der Vorbehaltsware bzw. der abgetretenen Forderungen sind unzulässig. Von Pfändungen ist der Verkäufer unter Angabe des Pfandgläubigers sofort zu benachrichtigen. 17/10. Nimmt der Verkäufer auf Grund des Eigentumsvorbehaltes den Liefergegenstand zurück, so liegt nur dann ein Rücktritt vom Vertrag vor, wenn der Verkäufer dies ausdrücklich erklärt. Der Verkäufer kann sich aus der zurückgenommenen Vorbehaltsware durch freihändigen Verkauf befriedigen. 17/11. Der Käufer verhandelt die Vorbehaltsware für den Verkäufer unentgeltlich. Er hat sie gegen die üblichen Gefahren wie z.B. Feuer, Diebstahl und Wasser im gebrauchlichen Umfang zu versichern. Der Käufer tritt hiermit seine Entschädigungsansprüche, die ihm aus Schäden der obengenannten Art gegen Versicherungsgesellschaften oder sonstige Ersatzpflichtige zustehen, an den Verkäufer in Höhe des Fakturenwertes der Ware ab. Der Verkäufer nimmt die Abtretung an. 17/12. Sämtliche Forderungen sowie die Rechte aus dem Eigentumsvorbehalt an allen in diesen Bedingungen festgelegten Sonderformen bleiben bis zur vollständigen Freistellung aus Eventualverbindlichkeiten, die der Verkäufer im interesse des Käufers eingegangen ist, bestehen.
- Die Ausstellung und/oder Annahme von Wechseln ändert nichts an den Verkaufsbedingungen und beinhaltet keineswegs Schuldumwandlung.
- Ohne andere schriftliche Vereinbarung ist immer das Belgische Recht auf der Vereinbarung anwendbare Recht. In Streitfällen ist das Gericht von Tongeren, Belgien allein zuständig.
- Reparaturkosten werden nicht durch Doxis akzeptiert falls dieses nicht vorab bestätigt und genehmigt wurde durch Doxis, sogar wenn die Verantwortlichkeit für dieser Reparatur bei Doxis liegt.

## General Terms of Sale.

- All our merchandises will be send against our general terms of sale.
- Our offers our valid for a period of 3 months or until a general price increase appears on the price list of Doxis Lighting Factory, which of both comes first.
- We take all useful steps in order to respect the terms of delivery and we do not accept any penalty of delay.
- In case of cancelling an order by the buyer, even if this cancelling only is partial, the buyer will be obliged to pay an indemnity of 30% of the amount of the cancelled order. We reserve the right to increase the indemnity in case we already started the preparation or the execution of the order.
- A delay in the delivery may not in any case lead to a cancellation of the order.
- The goods are dispatched at the own risks of the consignee. 7. In order to be valid any complaint must be made in writing to our firm, at the latest within the 5 days which follow the receipt of the goods.
- All the invoices are to be paid in our Seat of offices in Genk. 9. Our agents or representatives do not have authority to collect the amount of the invoice except explicit stipulation.
- The risk of change is chargeable to the buyer.
- In the absence of any express written provision to the contrary, all invoices are payable at 30 days.
- Any amount unpaid on the due date shall, automatically and without prior notice, attract interest at a rate 2 % above the Belgian legal interest rate, with a minimum interest rate of 12 %.
- We reserve the right to increase by 10 % the amount of any invoice unpaid on the due date. The minimum amount of any such increase shall be 250 €
- Should an invoice remain unpaid on the due date, all invoices shall immediately become due for payment, regardless of their original date of maturity.
- Should the buyer fail to honour his engagements, we may consider the contract cancelled and a letter sent by recorded delivery by us to the buyer shall be evidence of our exercise of this right. Such action shall not in any way limit or prejudice our other rights.
- If in our opinion there is a deterioration in the creditworthiness of the buyer on account of measures of judicial execution against the buyer and/or other negative demonstrable signs, we reserve the right to suspend all or part of any contract in operation and to ask the buyer to provide such guarantees we may deem proper to ensure proper fulfillment by the buyer of his engagements under the contract. Such request may be made before or after the delivery of all or part of any contract. Should the buyer fail to meet any reasonable demand for such a guarantee, we shall have the right to cancel all or part of any contracts in operation. Such action shall not in any way limit or prejudice our other rights for damage 17. Until payment in full to us for the goods the goods shall remain our property. Notwithstanding the foregoing, the risk in the goods and all liability to third parties in respect thereof shall pass to the buyer on delivery. The buyer shall be entitled to transform the goods or to incorporate them in a new product or products. In that case we reserve to ourself the legal and equitable title to the final product or products into which the goods are incorporated or mixed. The buyer shall store the final products separately and property of these products shall remain with us until full payment will have been made to us for the goods. The buyer may sell the goods in the normal course of his business but on condition that the buyer is in a fiduciary capacity as bailee of the goods, and for so long as he has not fully discharged his debt to us, shall hold and pursue claims for the proceeds of their sale equal to the price of the goods for and on behalf of us. The buyer shall fully pursue such claims and if necessary shall recover the sums due by legal process. The buyer shall if so required by us, allow us to conduct in the buyer's name legal proceedings in respect of the monies due on the sale of the goods. Any sums recovered by us as a result of such proceedings (including sums accepted by us as satisfaction thereof) shall be equal to the sums claimed) shall be applied to the payment of the monies due to us from the buyer and then to the reasonable costs incurred by us in the course of such proceedings. Any balance remaining shall be paid to the buyer. Prior to the sale of the goods, the buyer shall, so far as reasonably practicable, store the goods separately from similar goods of the buyer, mark the goods as our property and shall not remove, obliterate or in any manner alter any label, mark or other means we may have of identifying the goods.
- The conditions of this contract shall not be modified in any way by the drawing or acceptance of a bill of exchange or by any other arrangement, nor shall any such act constitute a novation.
- Unless there is a written agreement to the contrary, the Belgian Law is applicable law for the transaction. Disputes arising out of this contract shall be referred only to the Court of Tongeren, Belgium.
- Cost on repairs will not be accepted by Doxis unless previously confirmed and approved by Doxis, even if the responsibility is to be taken by Doxis.

Doxis Lighting Factory NV - Horizonlaan 30 – 3600 Genk - Belgium





All prices in this catalogue are excl. VAT  
Prices are not bound by type or printing errors and may have been changed since going to print.  
Technical specifications, descriptions and all other information in this catalogue are not binding.  
Doxis reserves the right to alter data provided in this catalogue without notice at any time.

